

TEST PELS INFANTS DE P4B

1. DIBUIXA UN QUADRAT



2. DIBUIXA UN RECTANGLE



3. DIBUIXA UN TRIANGLE



4. DIBUIXA UN CERCLE

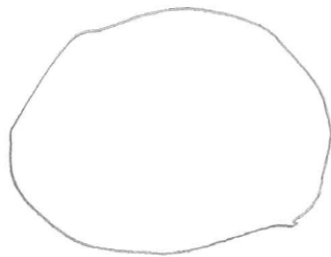

5. QUANTS COSTATS TENEN AQUESTES FIGURES GEOMÈTRIQUES I VÈRTEXS



Costats

Vertebs.

4

4

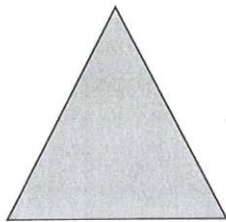

3

3



0

0

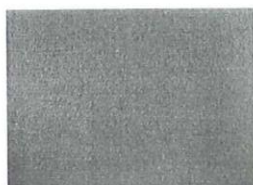

4

4

6. IDENTIFICA I ENCERCLA LES FIGURES GEOMÈTRIQUES.

- ENCERCLA ELS CERCLES

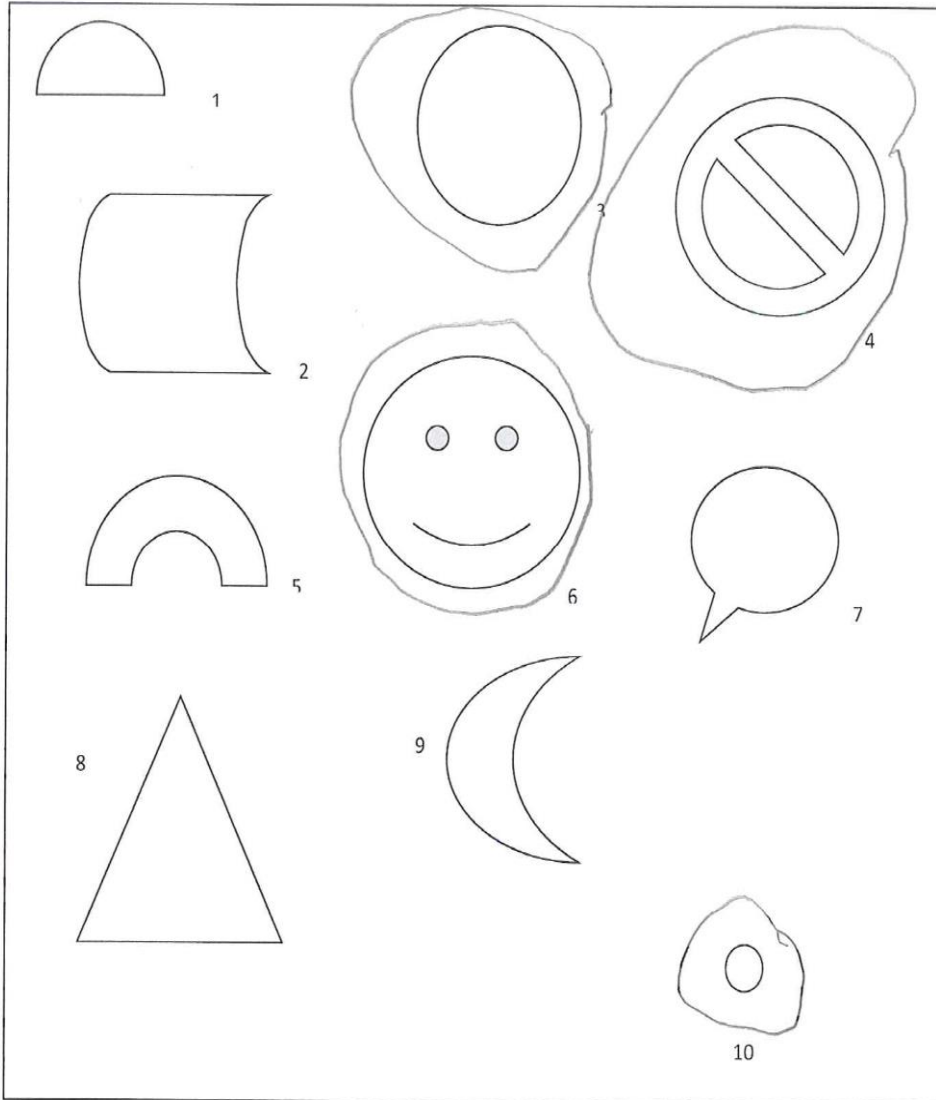

• ENCERCLA ELS QUADRATS

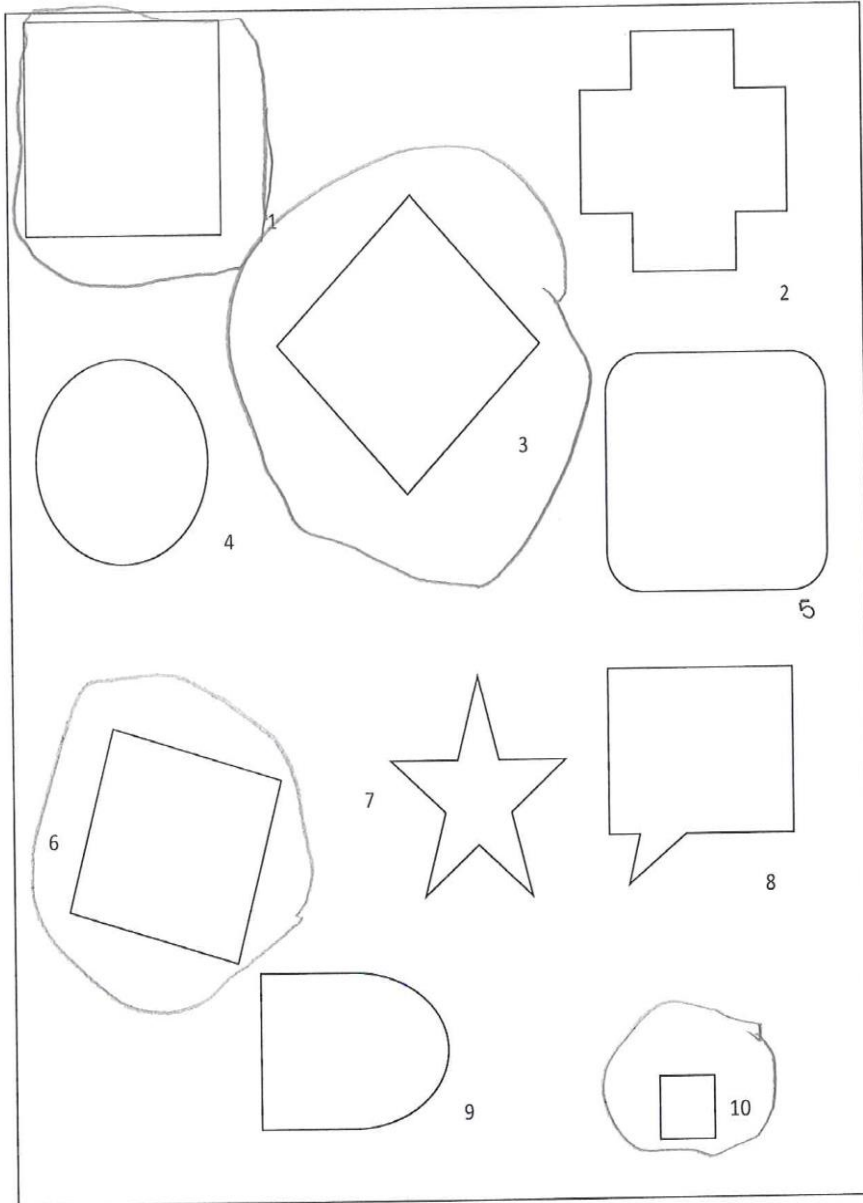

- ENCERCLA ELS RECTANGLES

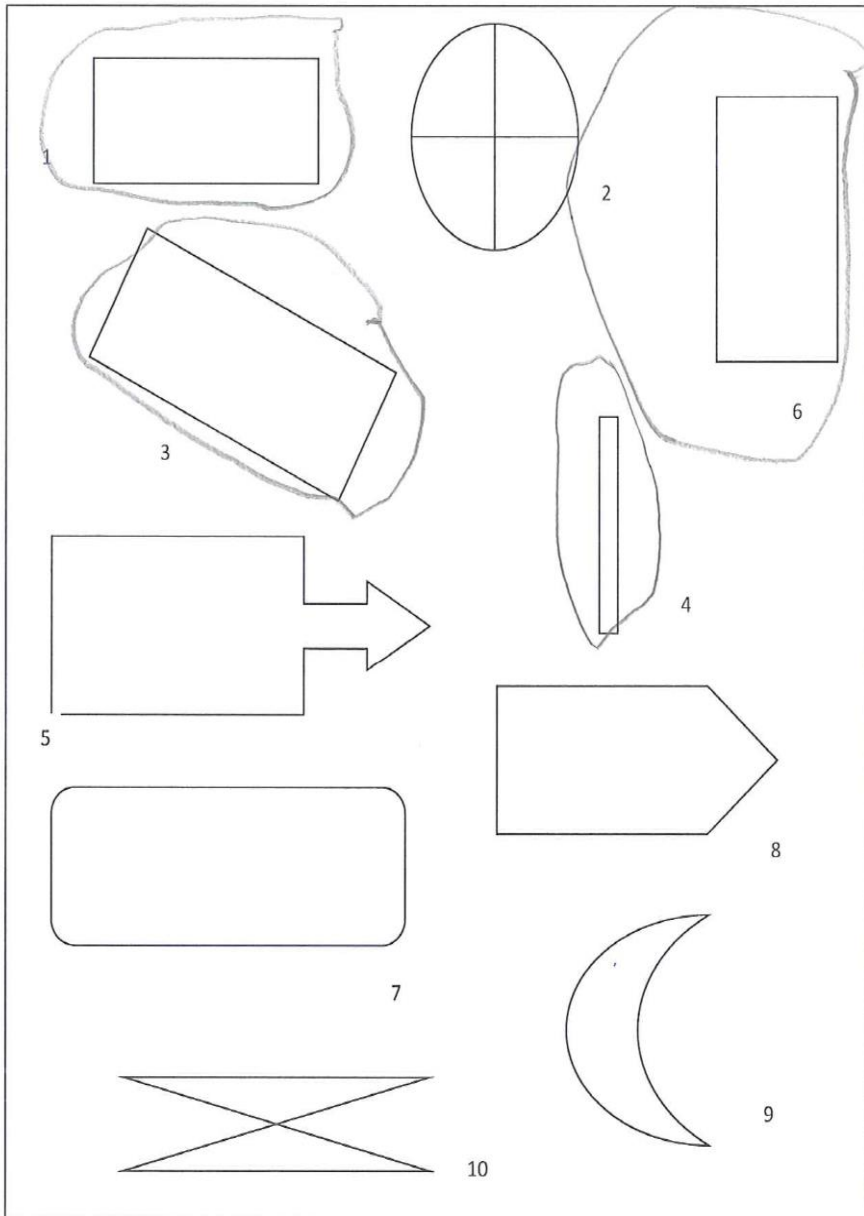

• ENCERCLA ELS TRIANGLES

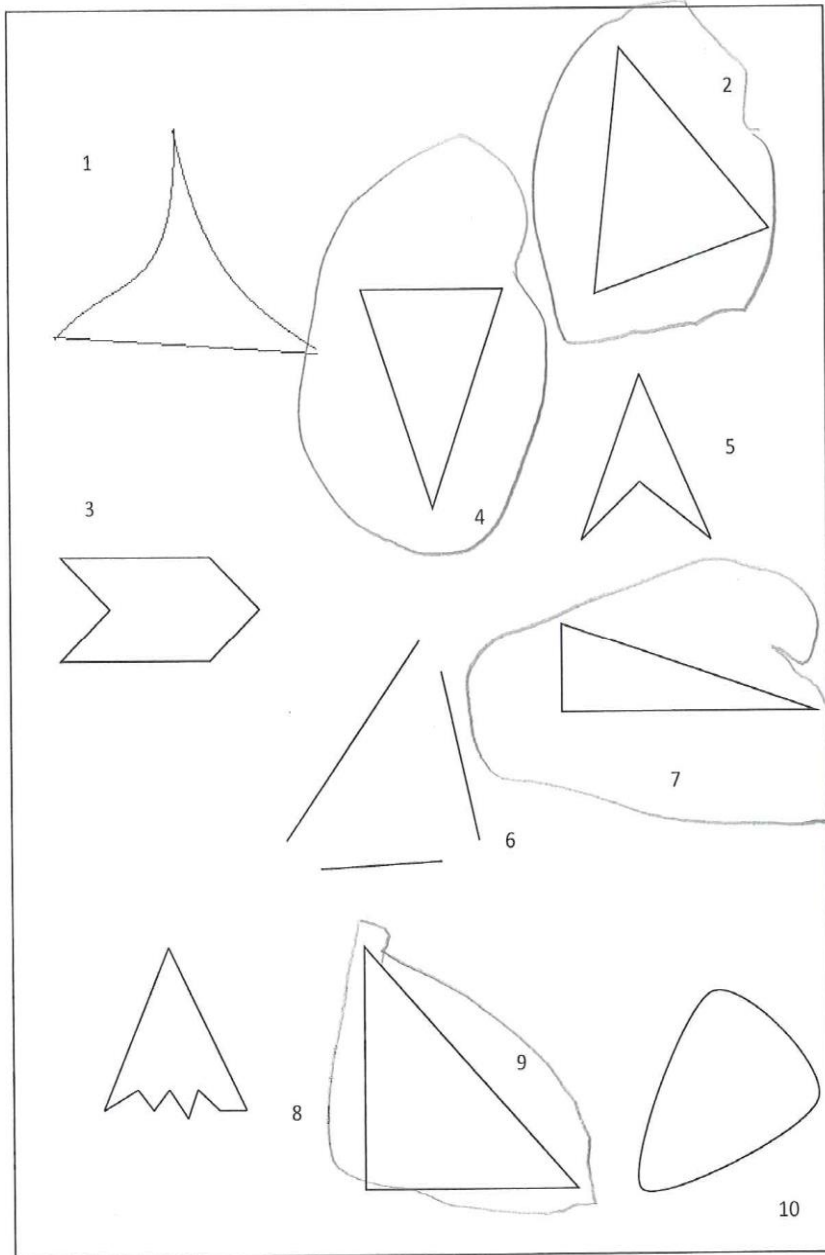

TEST PELS INFANTS DE P4B

1. DIBUIXA UN QUADRAT



2. DIBUIXA UN RECTANGLE

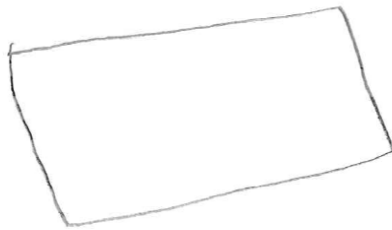

3. DIBUIXA UN TRIANGLE



4. DIBUIXA UN CERCLE



5

5. QUANTS COSTATS TENEN AQUESTES FIGURES GEOMÈTRIQUES I VÈRTEXS

Costats      Vèrtexs



4

4

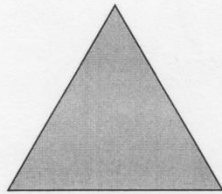

3

3

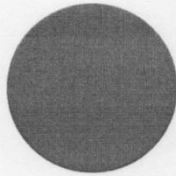

0

0

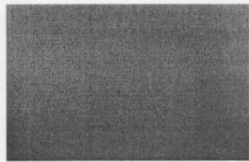

4

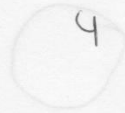



6. IDENTIFICA I ENCERCLA LES FIGURES GEOMÈTRIQUES.

- ENCERCLA ELS CERCLES

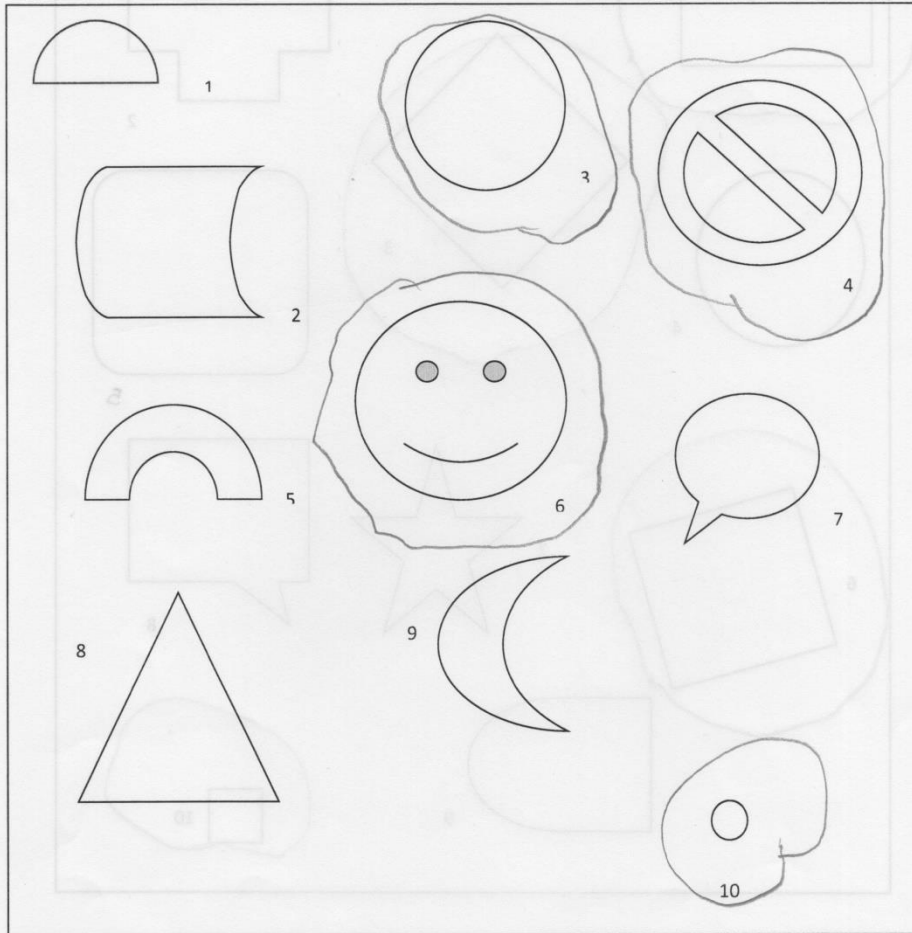

• ENCERCLA ELS QUADRATS

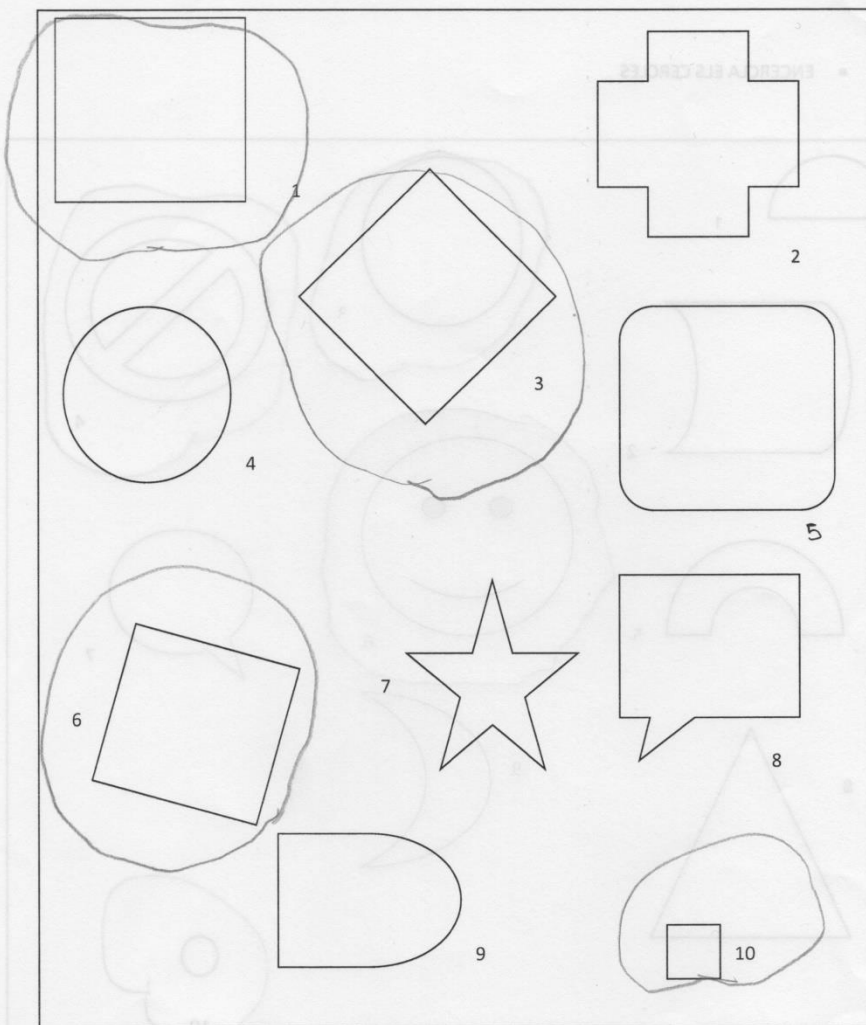

• ENCERCLA ELS RECTANGLES

ENCERCLA ELS TRIANGLES

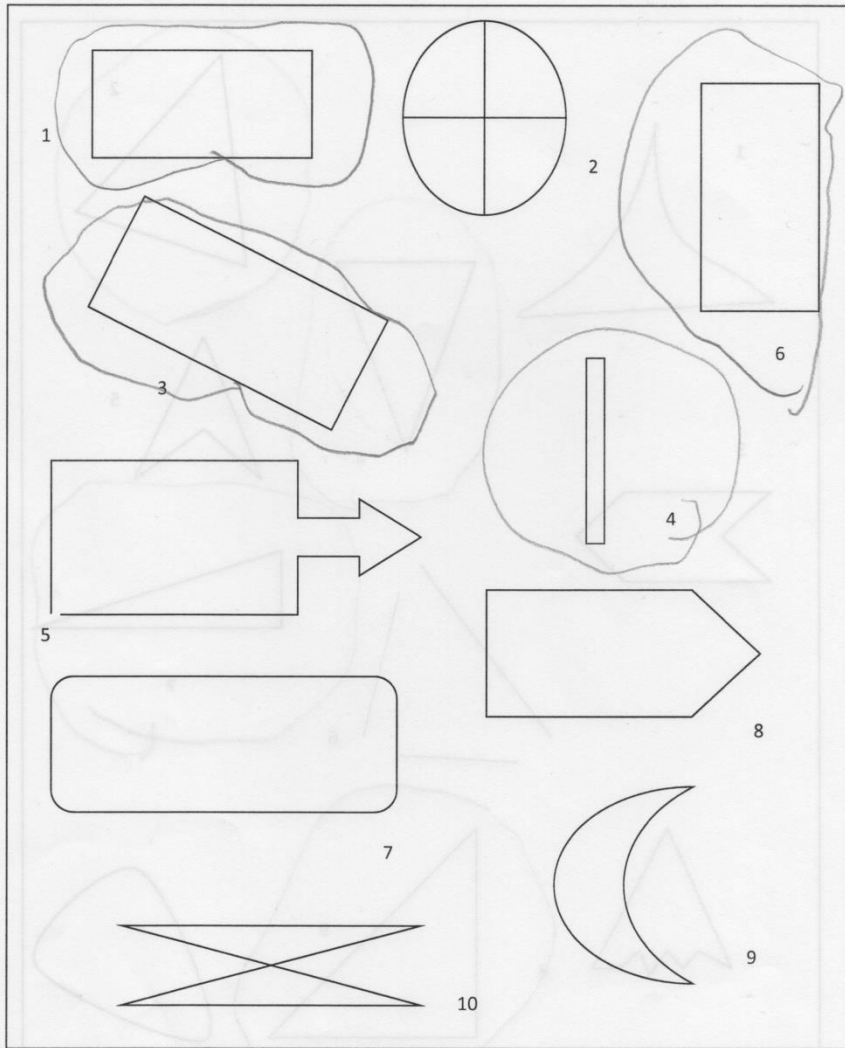

• ENCERCLA ELS TRIANGLES

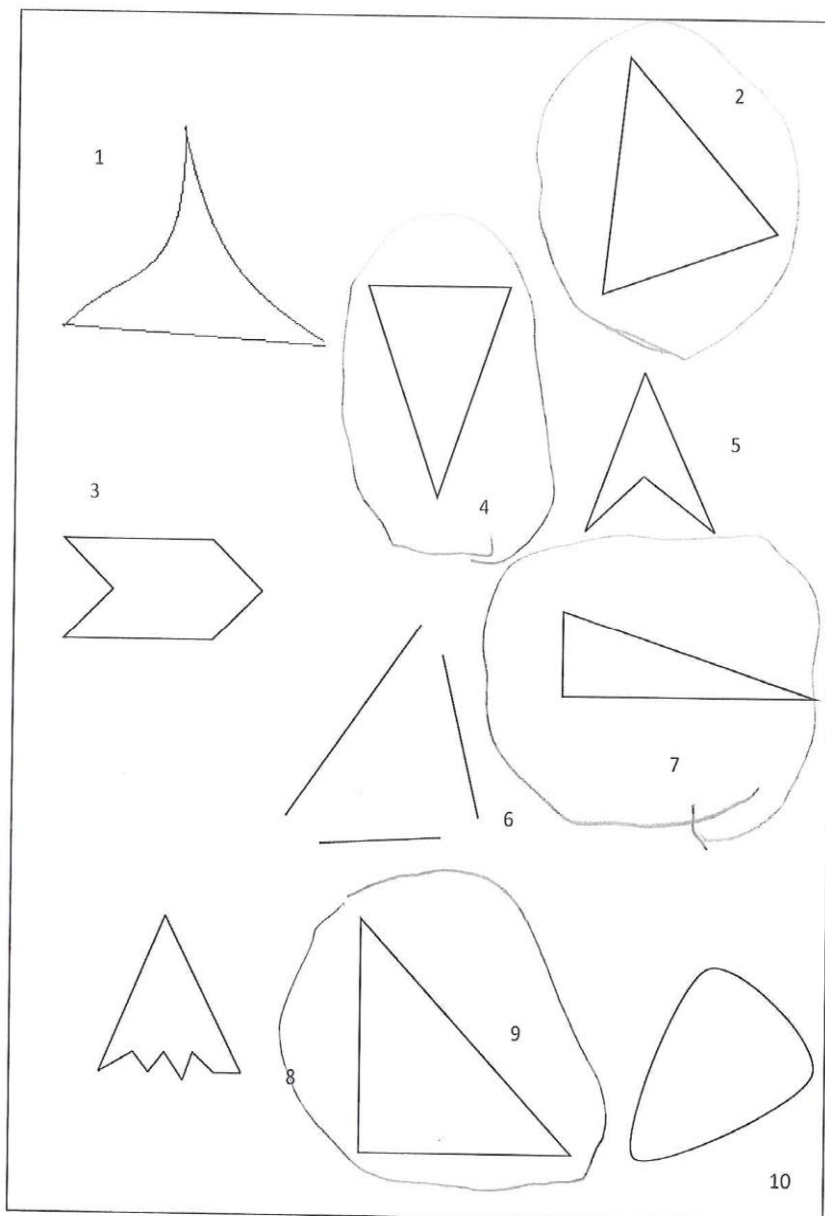

TEST PELS INFANTS DE P4B

1. DIBUIXA UN QUADRAT



2. DIBUIXA UN RECTANGLE



3. DIBUIXA UN TRIANGLE



4. DIBUIXA UN CERCLE



5. QUANTS COSTATS TENEN AQUESTES FIGURES GEOMÈTRIQUES I VÈRTEXS

Costats Vèrtexs.



4 4

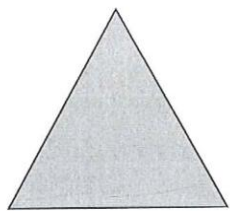

3 3



0 0



4 4

6. IDENTIFICA I ENCERCLA LES FIGURES GEOMÈTRIQUES.

- ENCERCLA ELS CERCLES

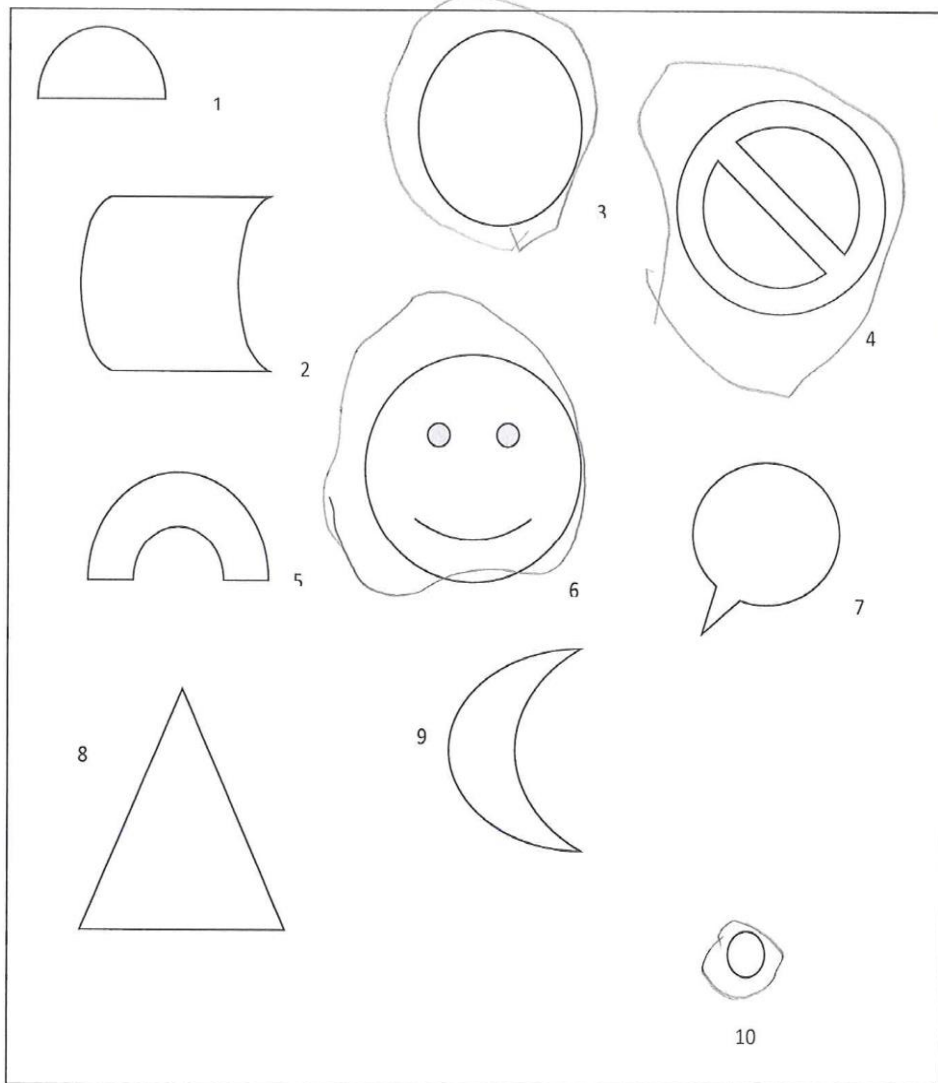

• ENCERCLA ELS QUADRATS

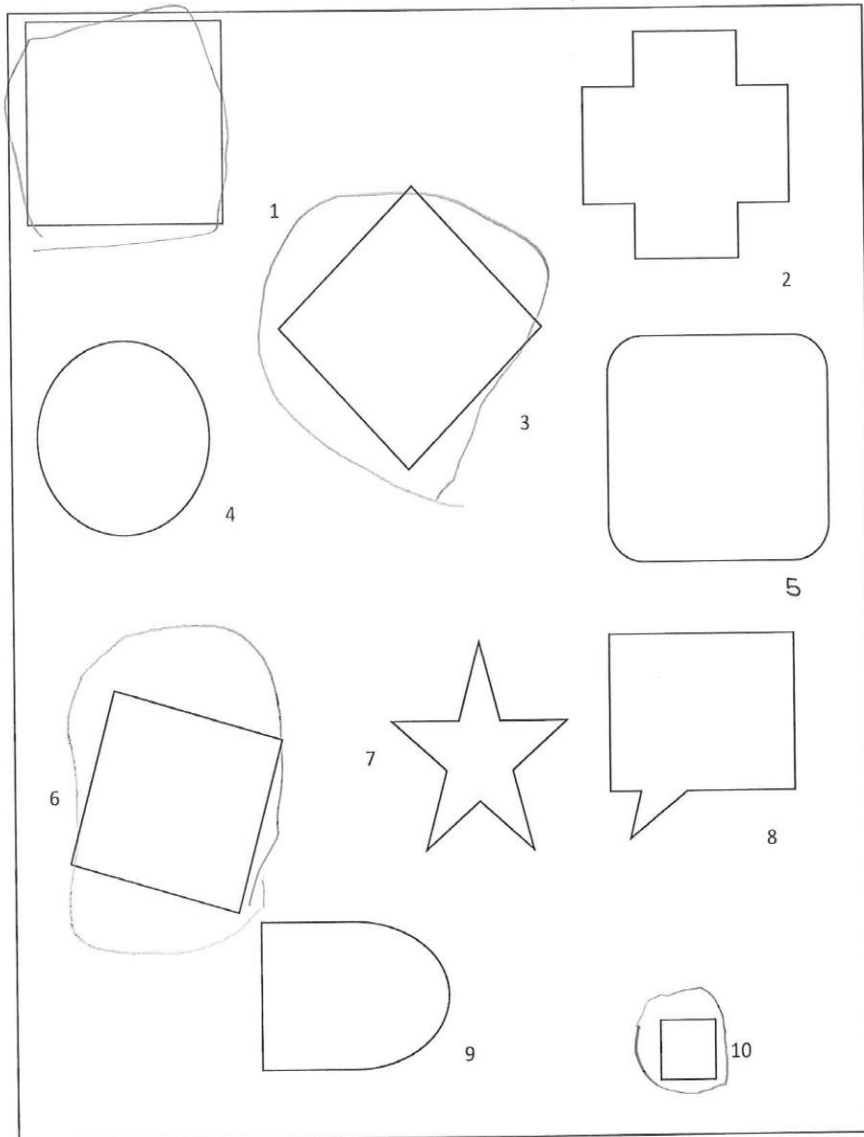



- ENCERCLA ELS RECTANGLES

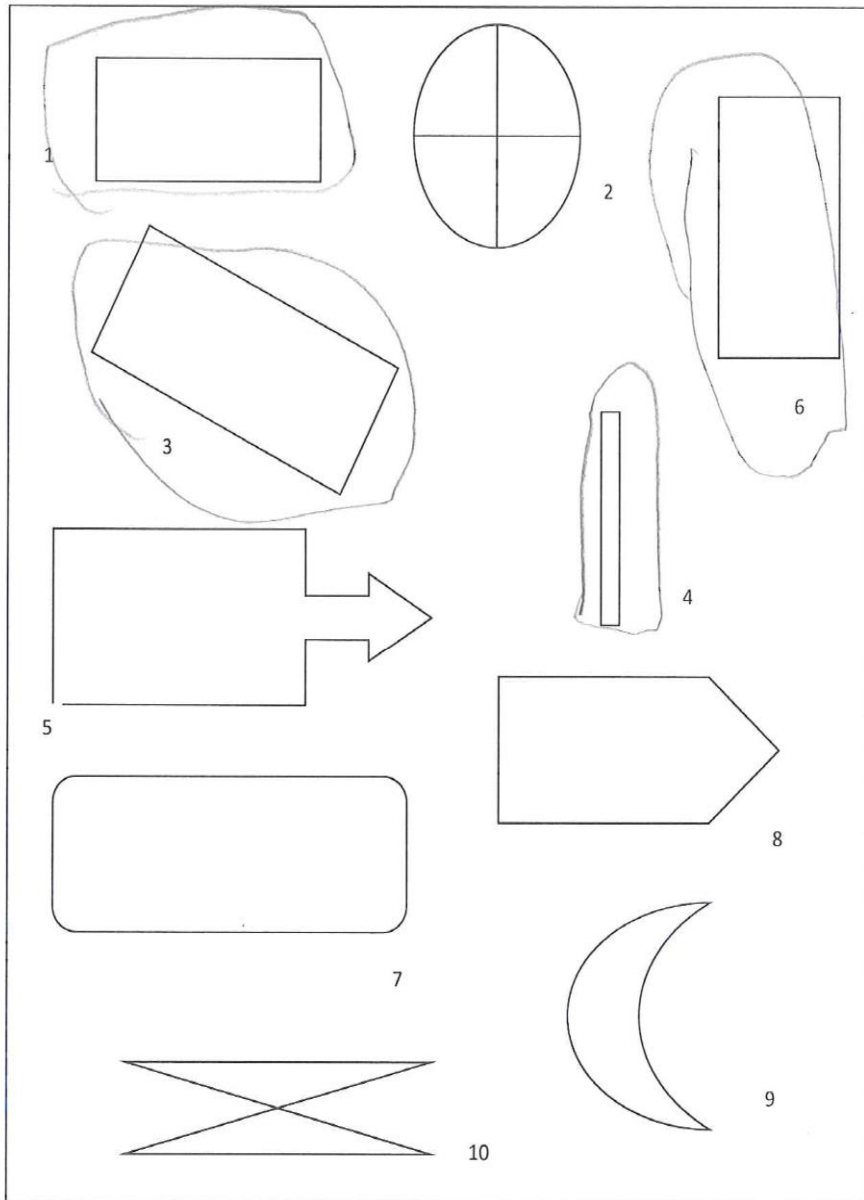

• ENCERCLA ELS TRIANGLES

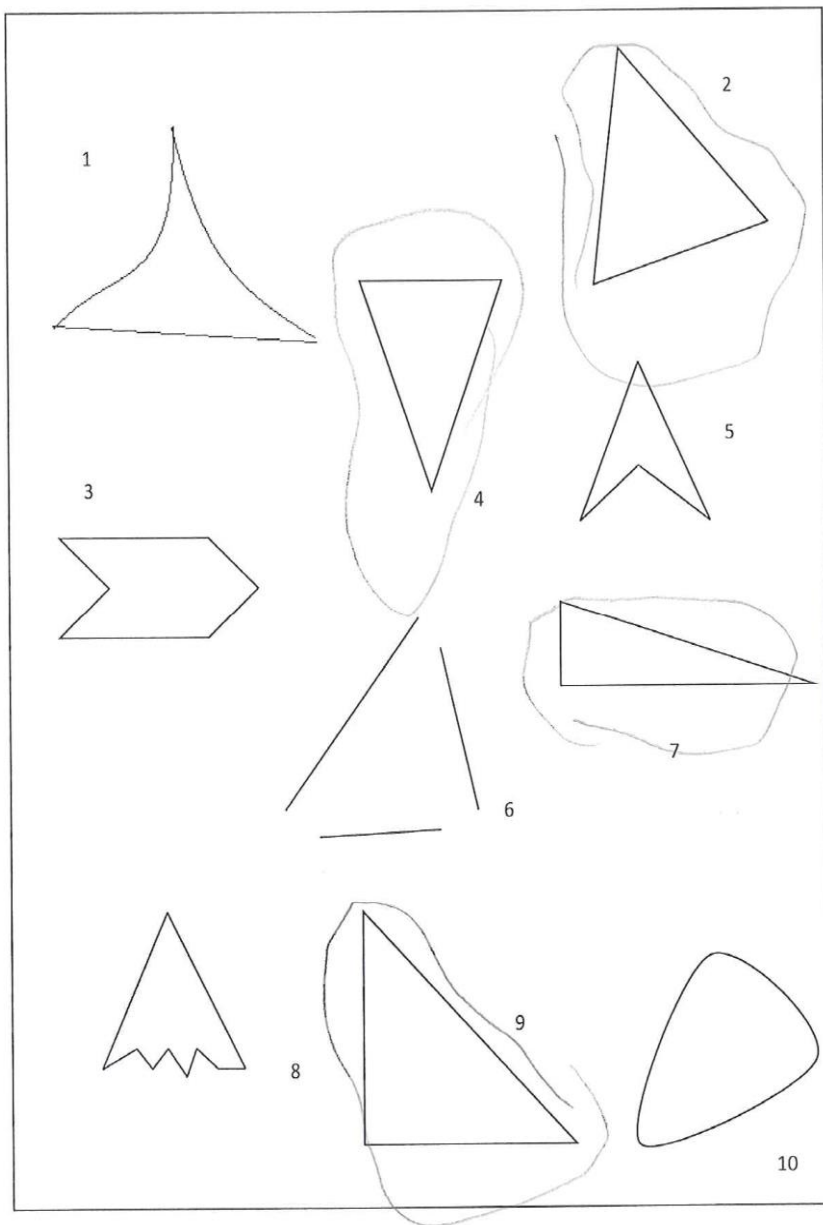

TEST PELS INFANTS DE P4B

1. DIBUIXA UN QUADRAT

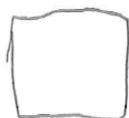

2. DIBUIXA UN RECTANGLE



3. DIBUIXA UN TRIANGLE



4. DIBUIXA UN CERCLE

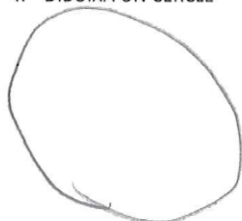

5. QUANTS COSTATS TENEN AQUESTES FIGURES GEOMÈTRIQUES I VÈRTEXS



Costats

4

Vèrtexs

4

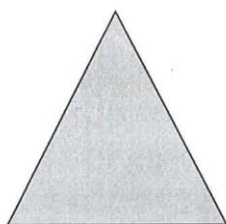

3

3



0

0



4

4

6. IDENTIFICA I ENCERCLA LES FIGURES GEOMÈTRIQUES.

- ENCERCLA ELS CERCLES

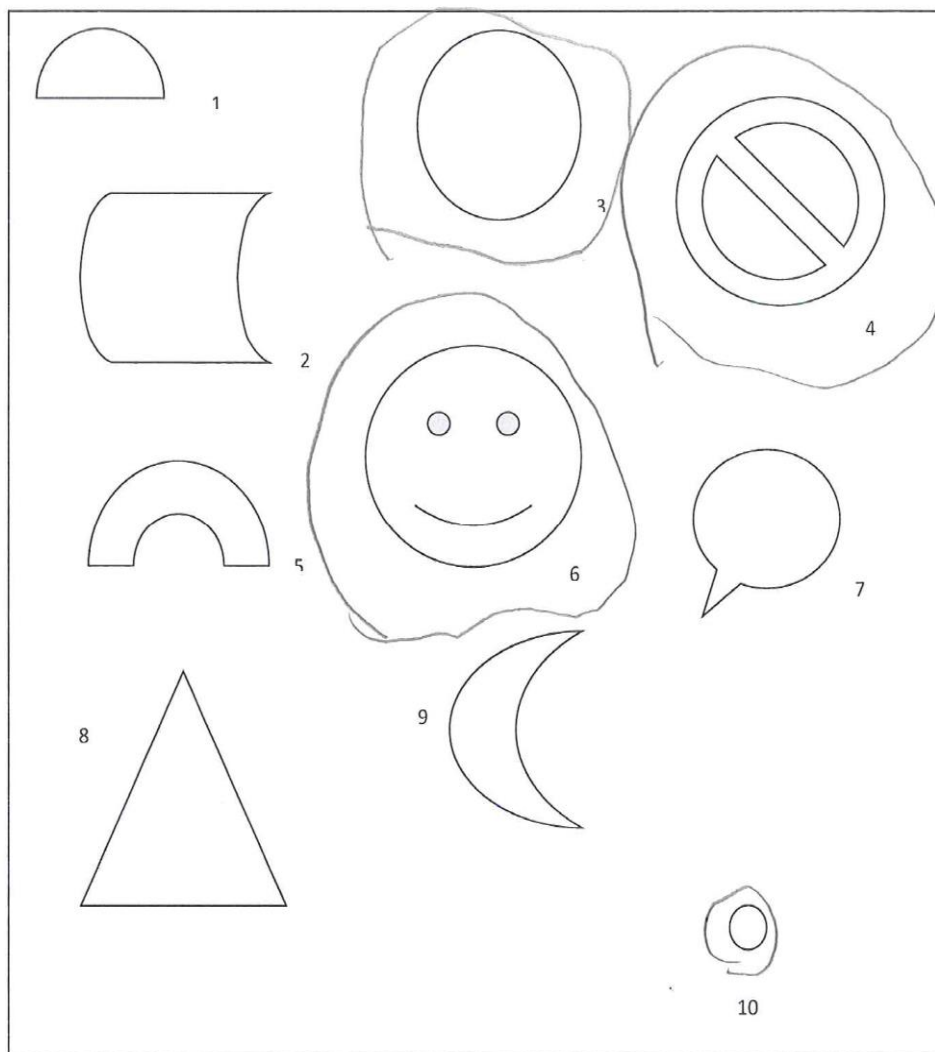

• ENCERCLA ELS QUADRATS

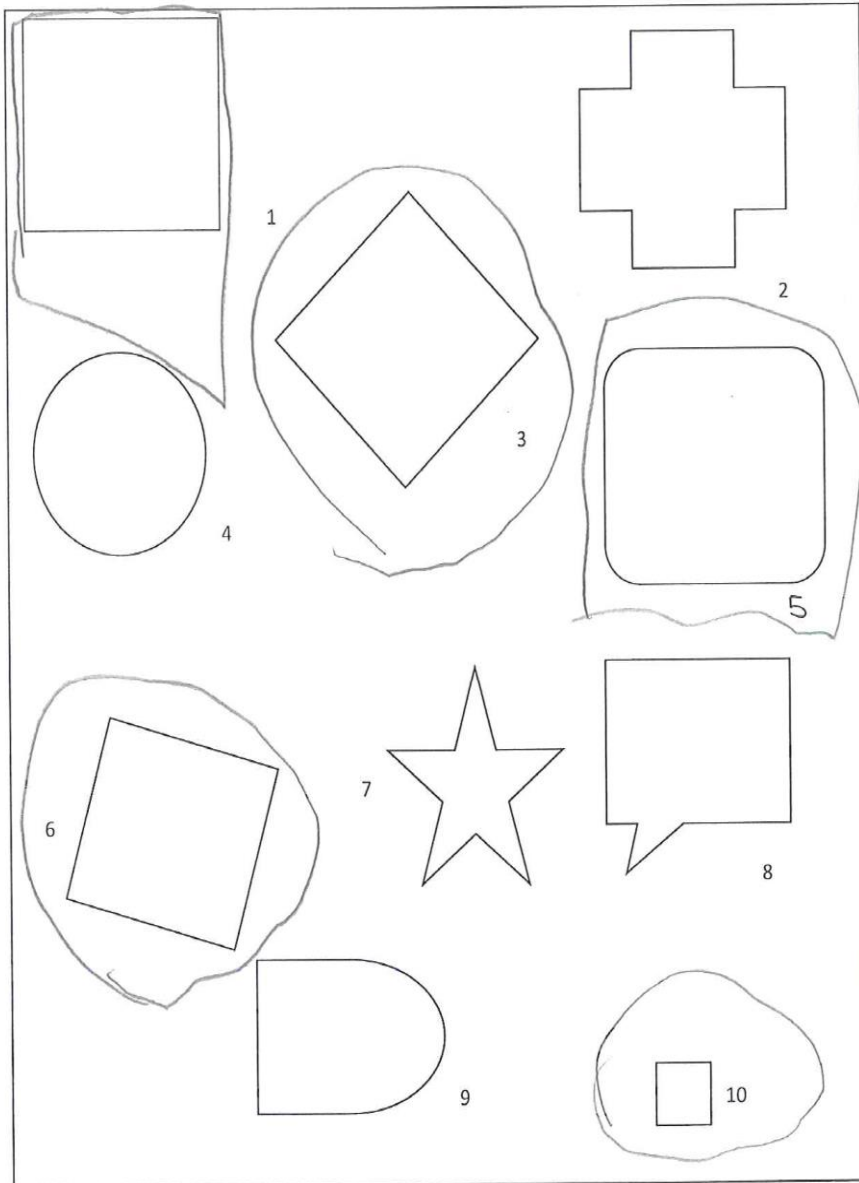

• ENCERCLA ELS RECTANGLES

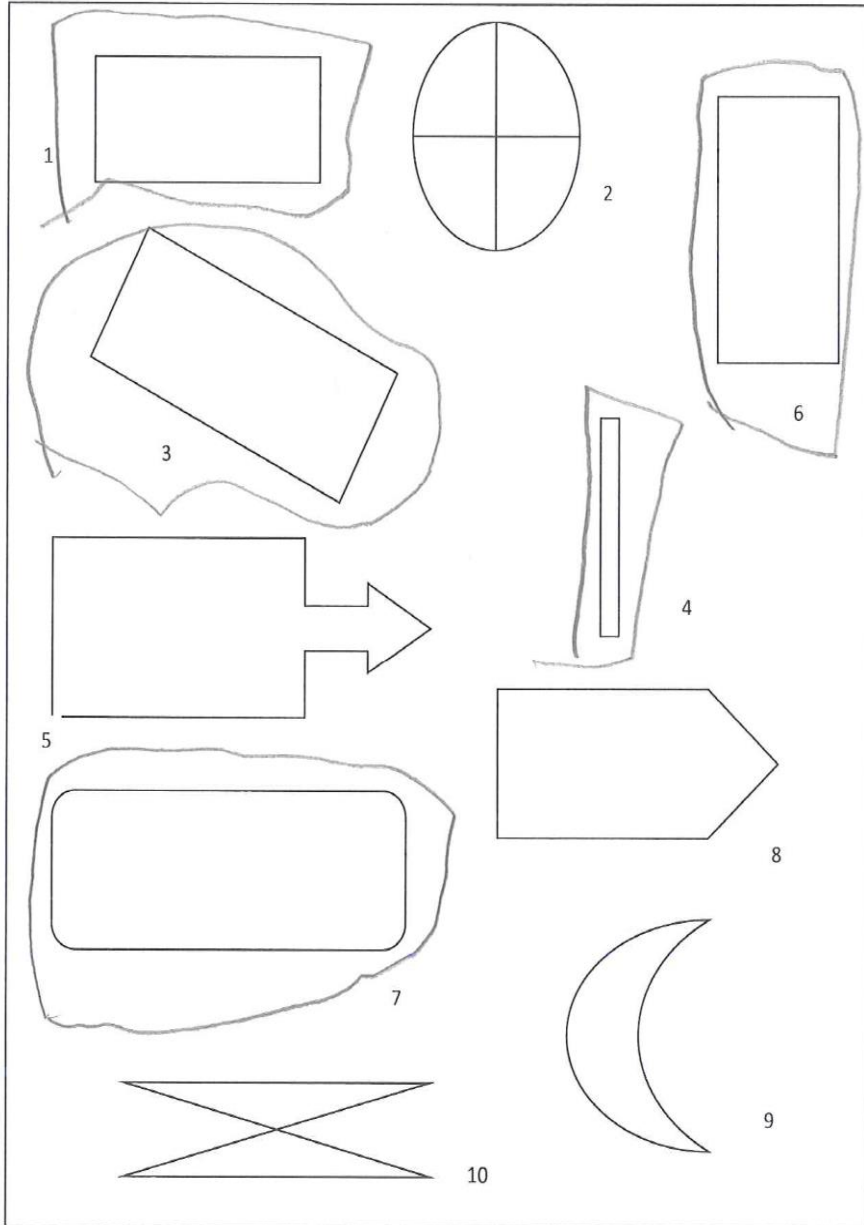

• ENCERCLA ELS TRIANGLES

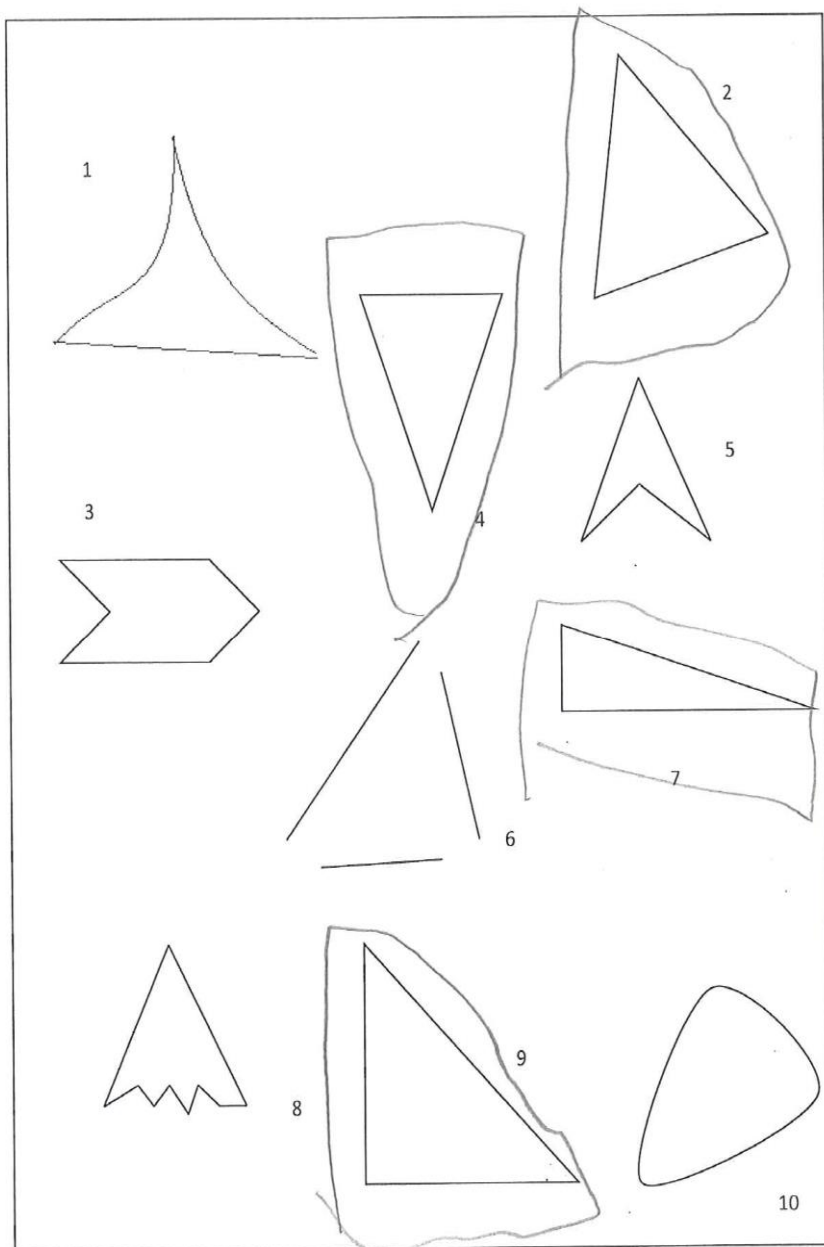



TEST PELS INFANTS DE P4B

1. DIBUIXA UN QUADRAT



2. DIBUIXA UN RECTANGLE

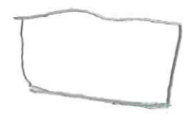

3. DIBUIXA UN TRIANGLE



4. DIBUIXA UN CERCLE



5. QUANTS COSTATS TENEN AQUESTES FIGURES GEOMÈTRIQUES I VÈRTEXS



Costats

Vèrtexs.

4

4

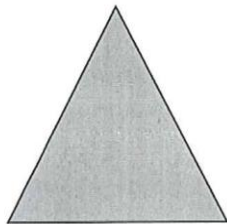

3

3



0

0



4

4

6. IDENTIFICA I ENCERCLA LES FIGURES GEOMÈTRIQUES.

- ENCERCLA ELS CERCLES

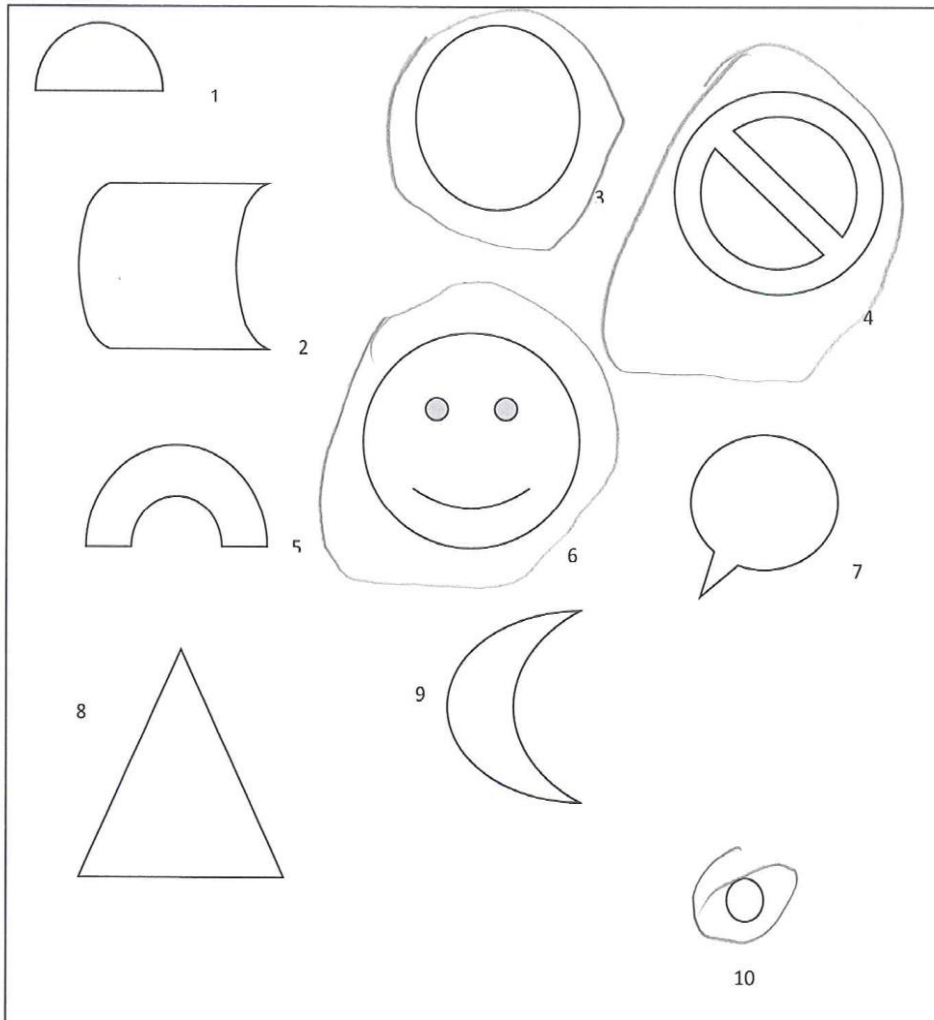

• ENCERCLA ELS QUADRATS

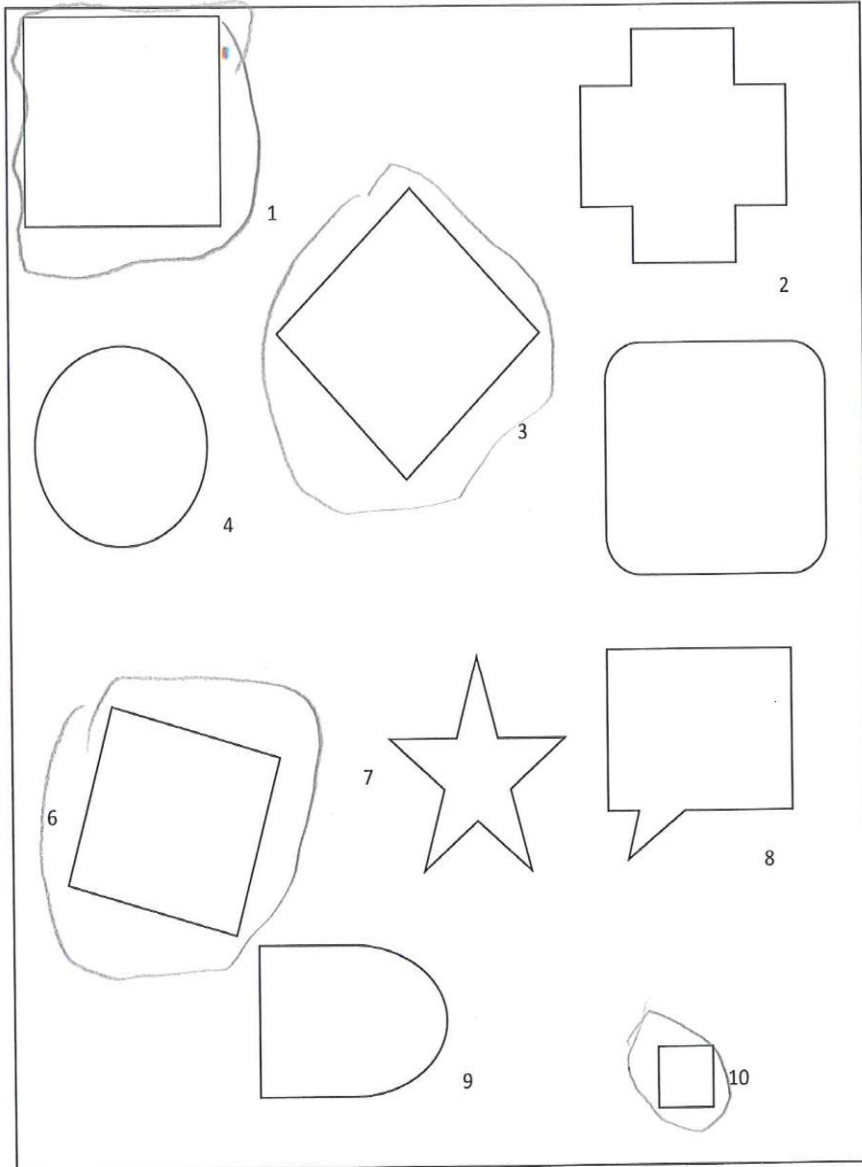

- ENCERCLA ELS RECTANGLES

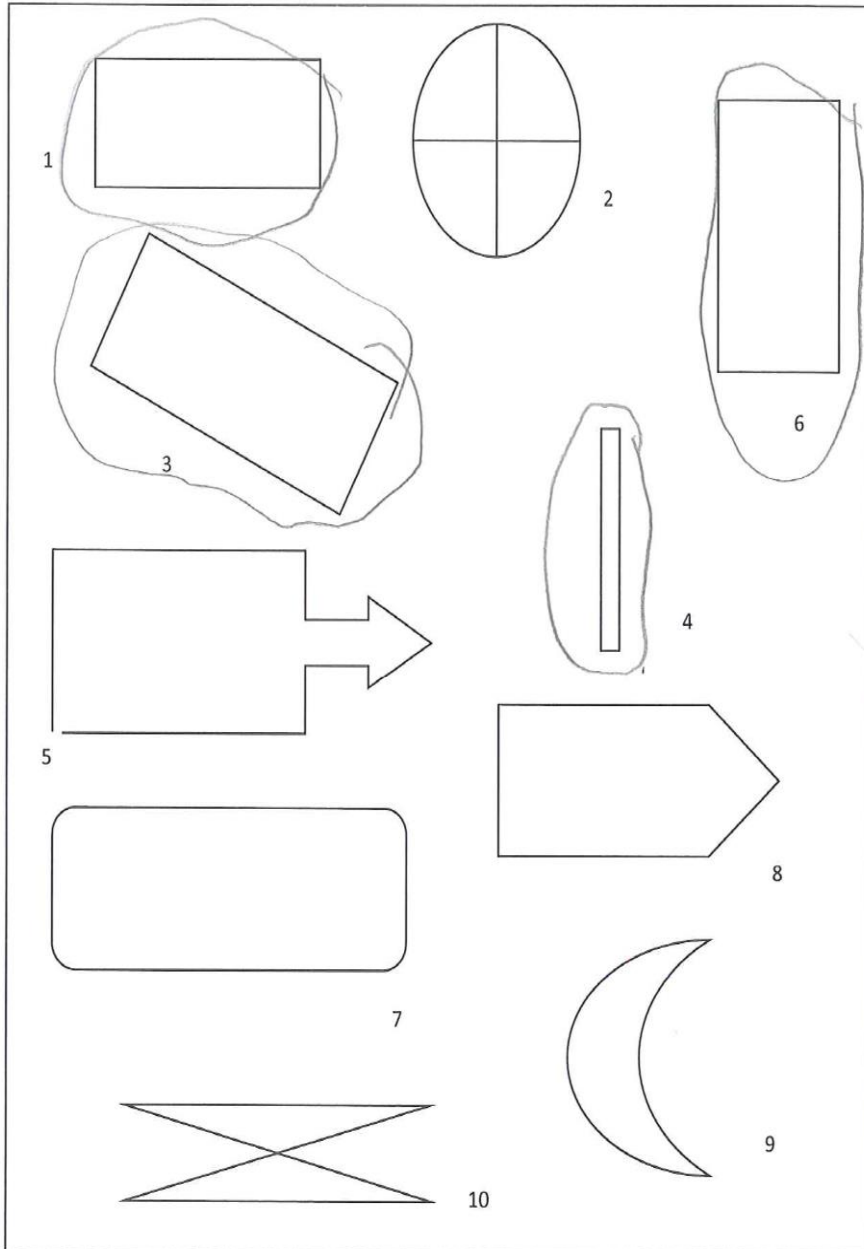

• ENCERCLA ELS TRIANGLES

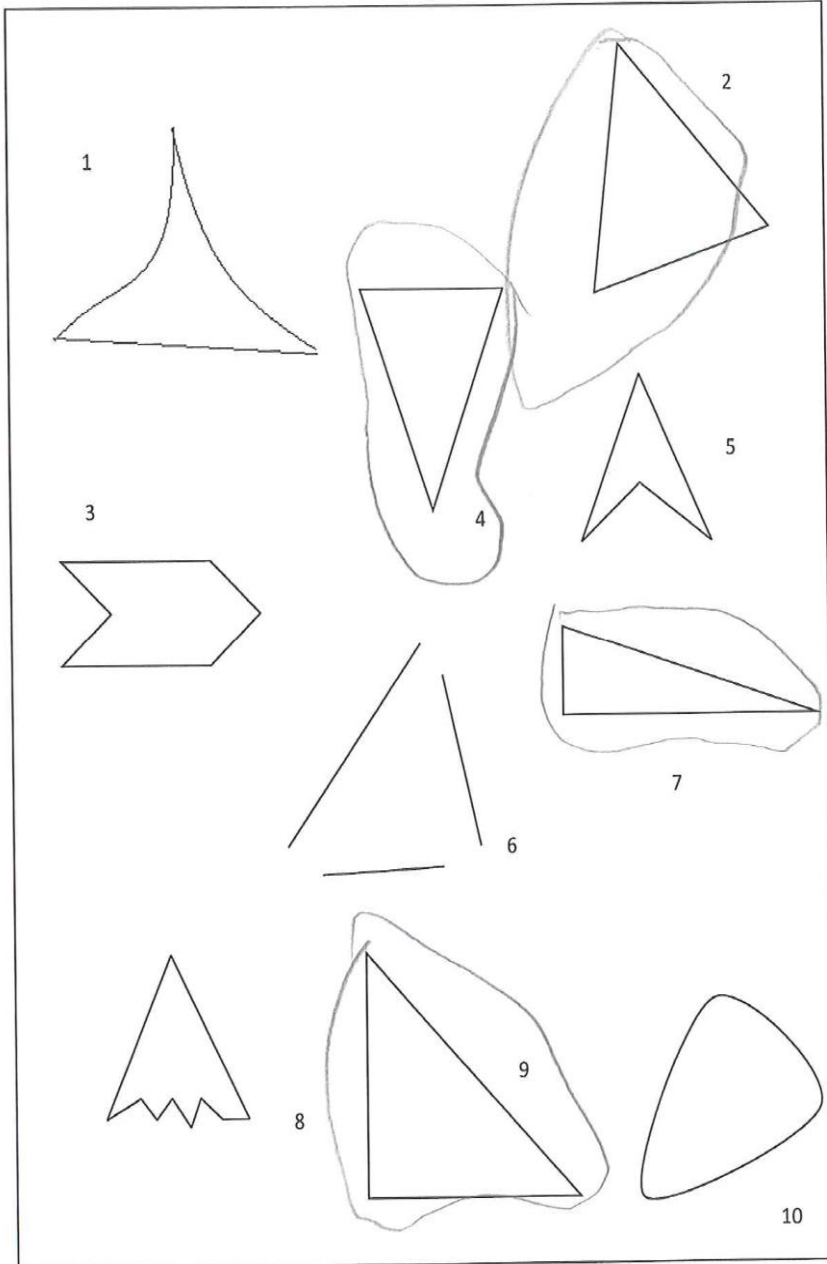

6

TEST PELS INFANTS DE P4B

1. DIBUIXA UN QUADRAT

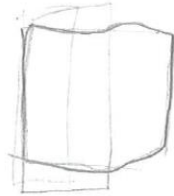

2. DIBUIXA UN RECTANGLE



3. DIBUIXA UN TRIANGLE



4. DIBUIXA UN CERCLE



5. QUANTS COSTATS TENEN AQUESTES FIGURES GEOMÈTRIQUES I VÈRTEXS



Costats

4

Vèrtexs

4

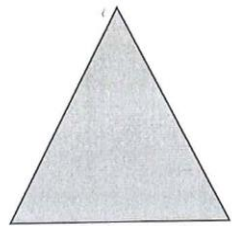

3

3



0

0



4

4



6. IDENTIFICA I ENCERCLA LES FIGURES GEOMÈTRIQUES.

- ENCERCLA ELS CERCLES

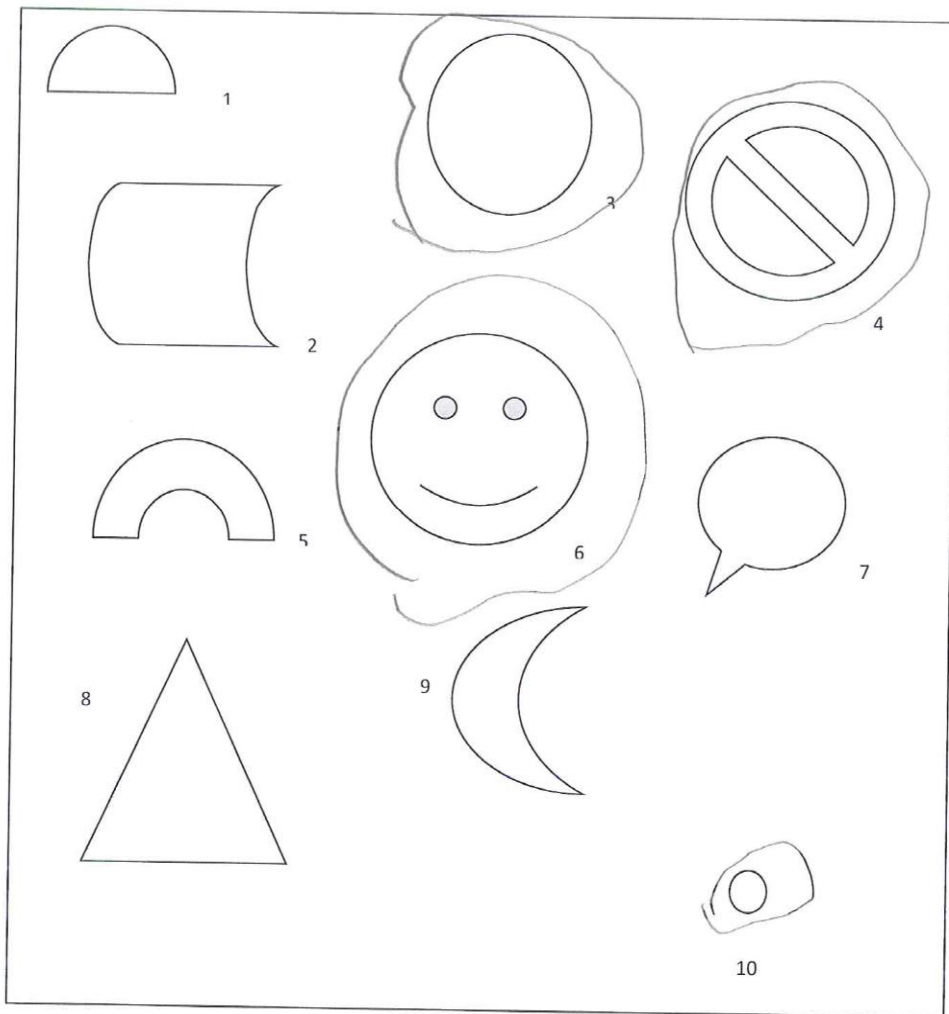

• ENCERCLA ELS QUADRATS

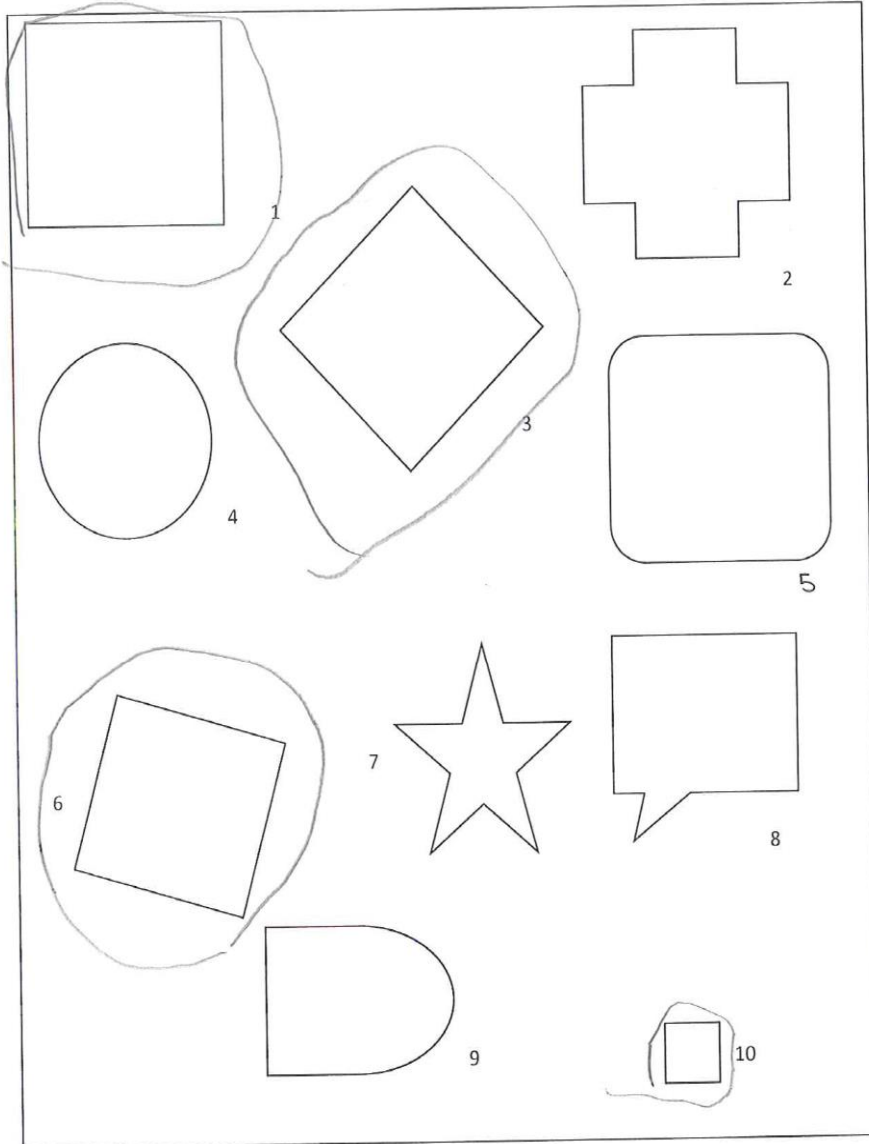

• ENCERCLA ELS RECTANGLES

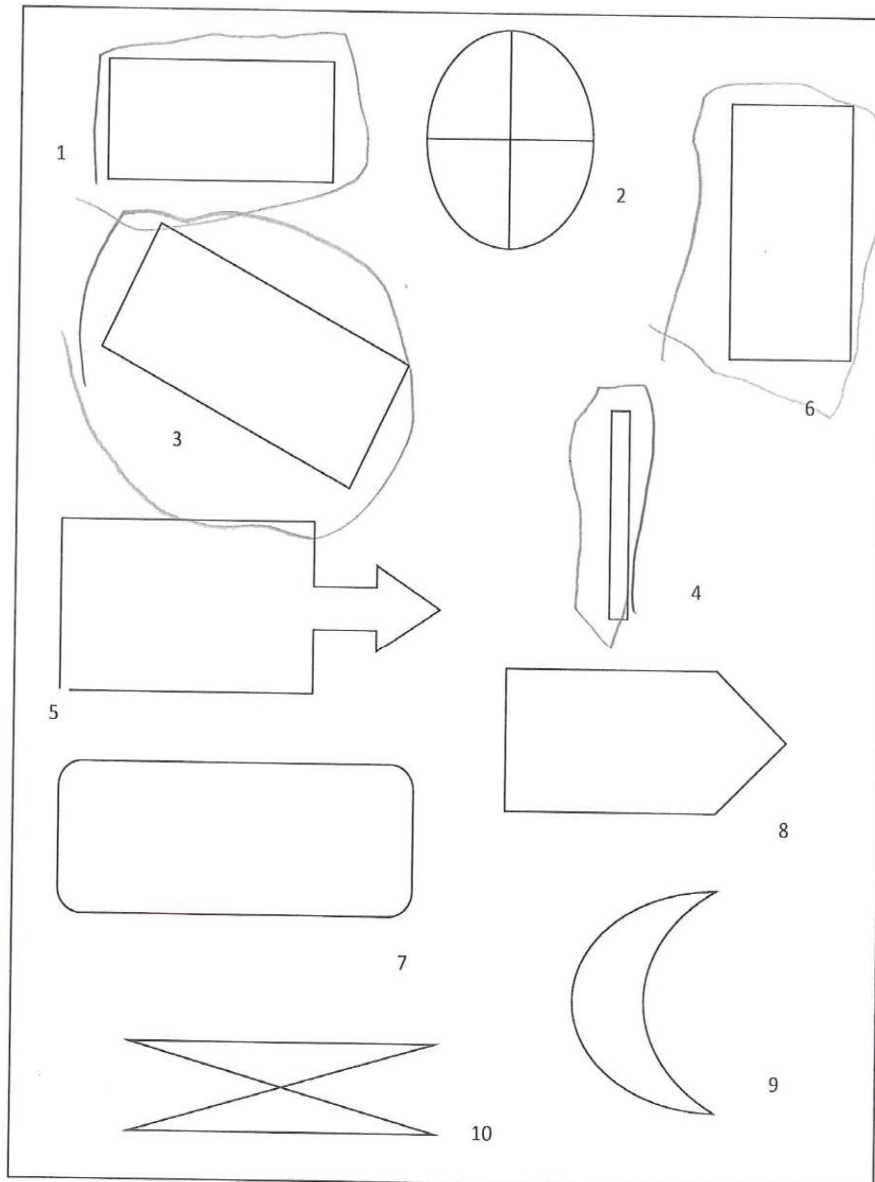

• ENCERCLA ELS TRIANGLES

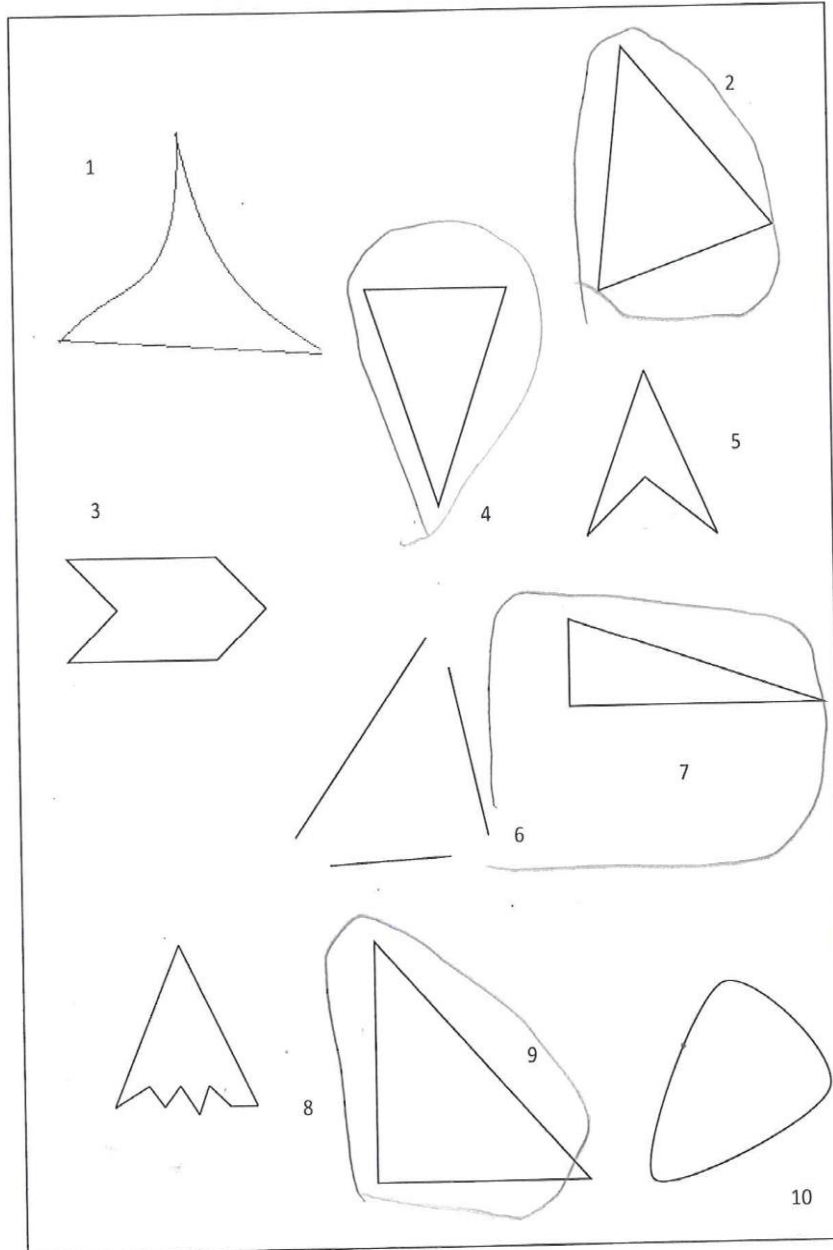

TEST PELS INFANTS DE P4B

1. DIBUIXA UN QUADRAT

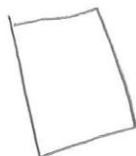

2. DIBUIXA UN RECTANGLE

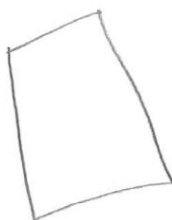

3. DIBUIXA UN TRIANGLE



4. DIBUIXA UN CERCLE



5. QUANTS COSTATS TENEN AQUESTES FIGURES GEOMÈTRIQUES I VÈRTEXS



Costats

4

Vèrtexs .

4

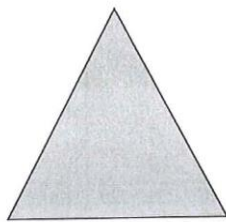

3

3



0

0



4

4

6. IDENTIFICA I ENCERCLA LES FIGURES GEOMÈTRIQUES.

- ENCERCLA ELS CERCLES

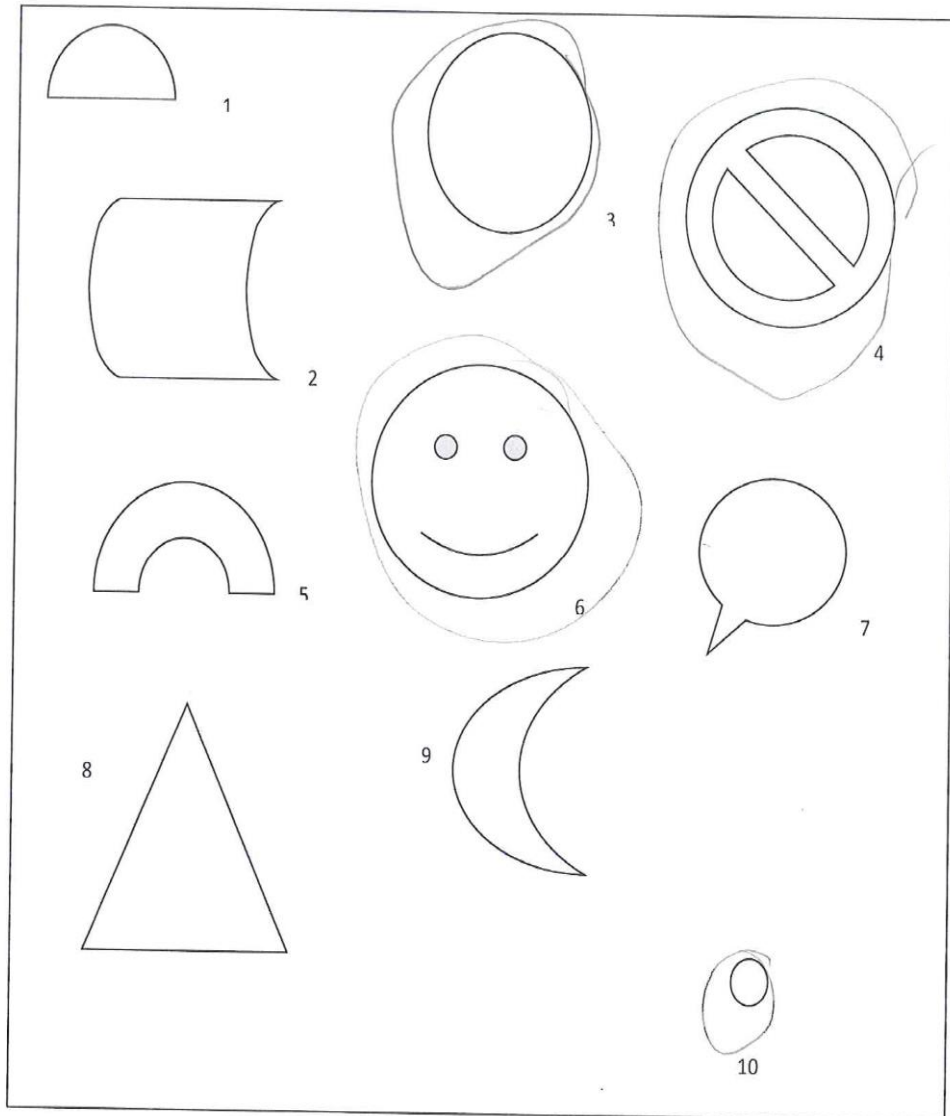

• ENCERCLA ELS QUADRATS

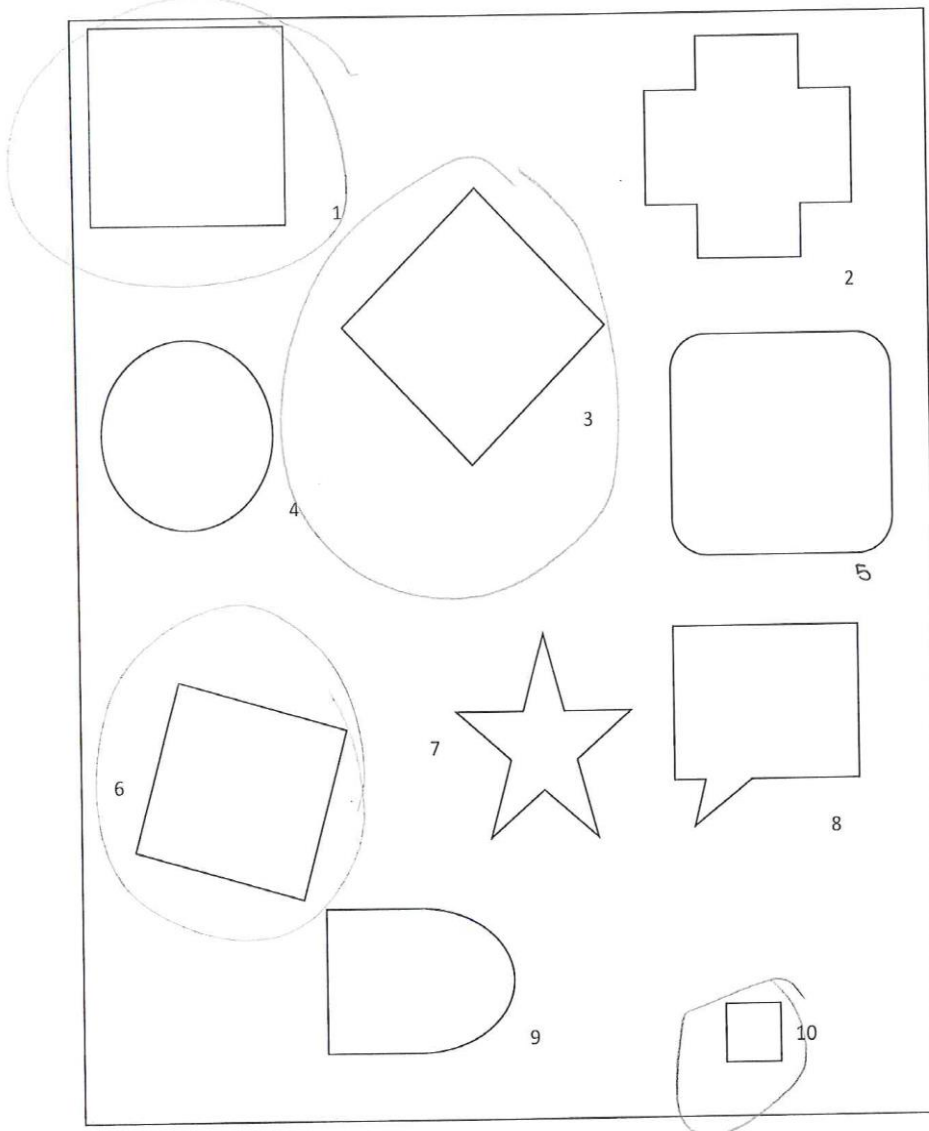



- ENCERCLA ELS RECTANGLES

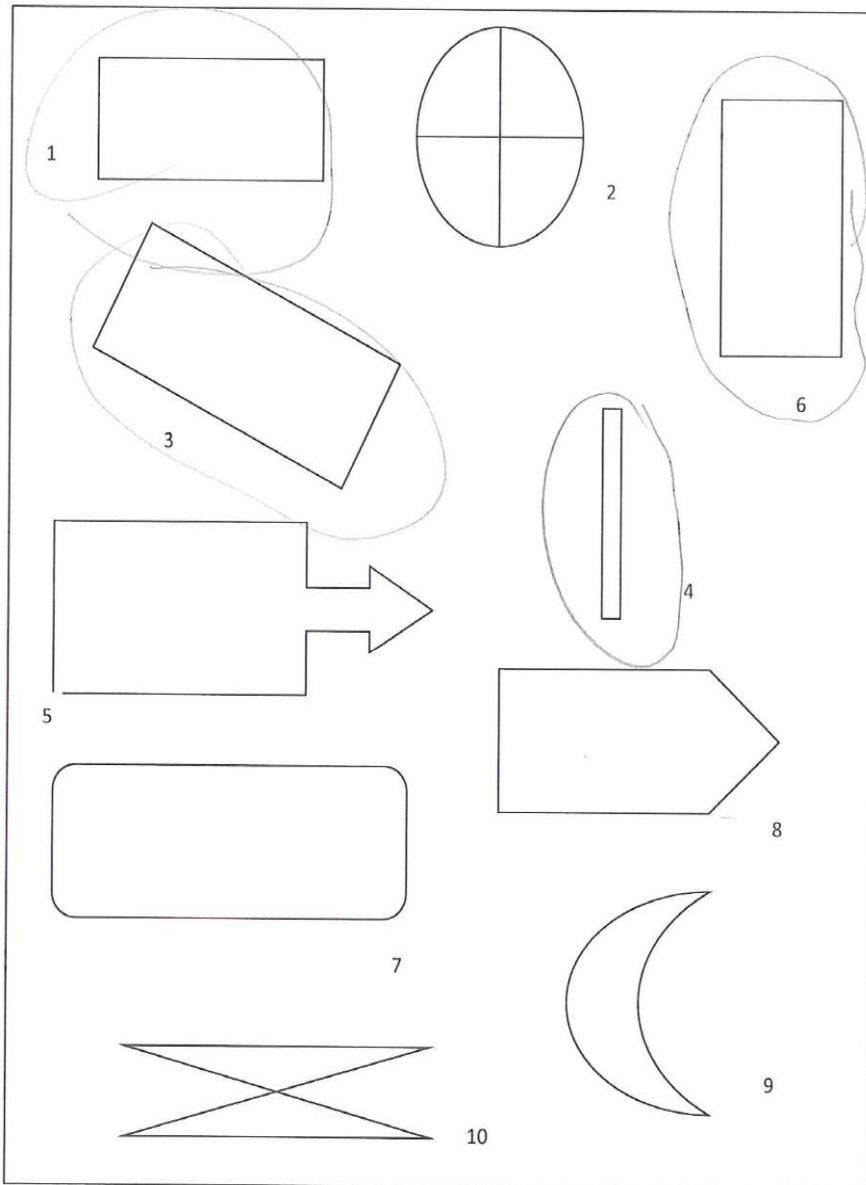

• ENCERCLA ELS TRIANGLES

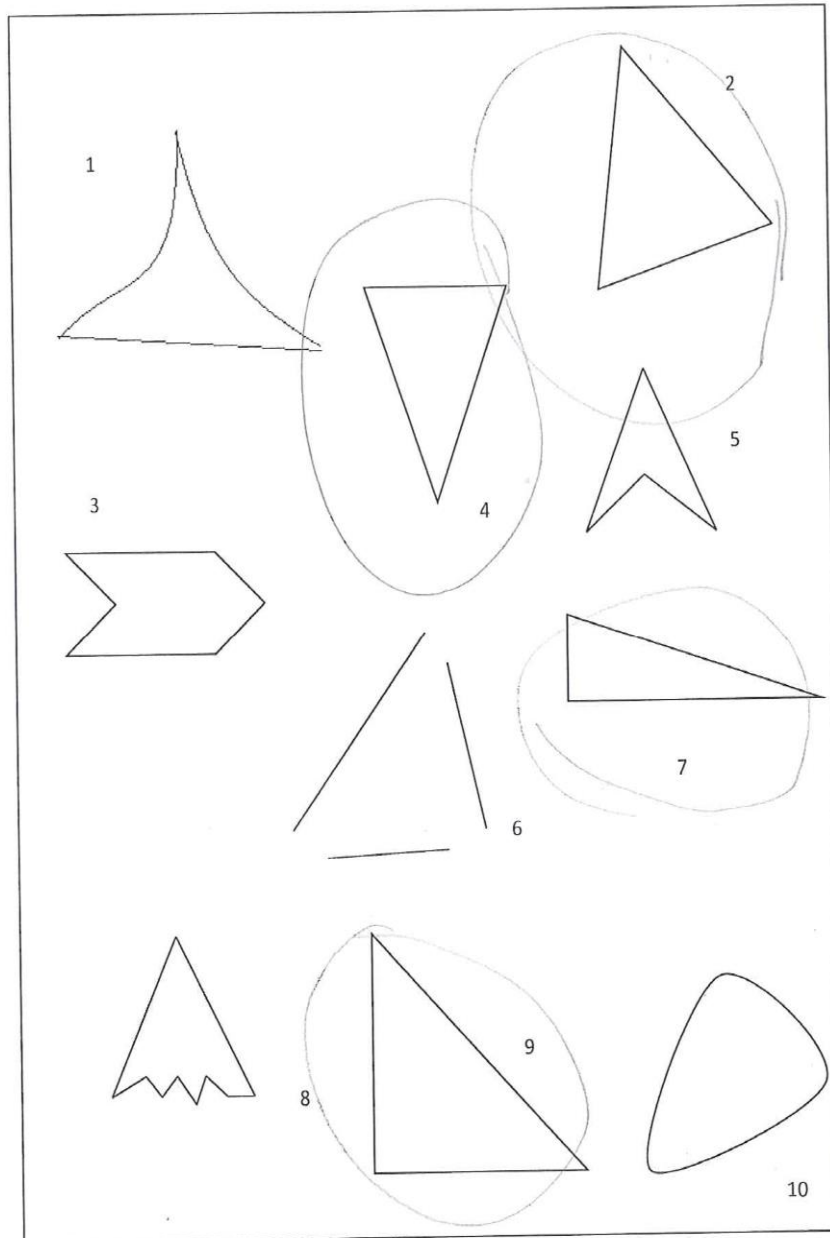

TEST PELS INFANTS DE P4B

1. DIBUIXA UN QUADRAT



2. DIBUIXA UN RECTANGLE

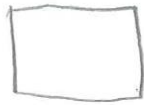

3. DIBUIXA UN TRIANGLE



4. DIBUIXA UN CERCLE



5. QUANTS COSTATS TENEN AQUESTES FIGURES GEOMÈTRIQUES I VÈRTEXS



Costats      Vèrtexs.

4

4

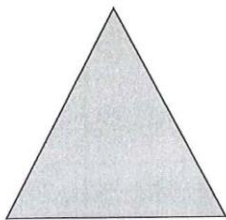

3

3



0

0



4

4

6. IDENTIFICA I ENCERCLA LES FIGURES GEOMÈTRIQUES.

- ENCERCLA ELS CERCLES

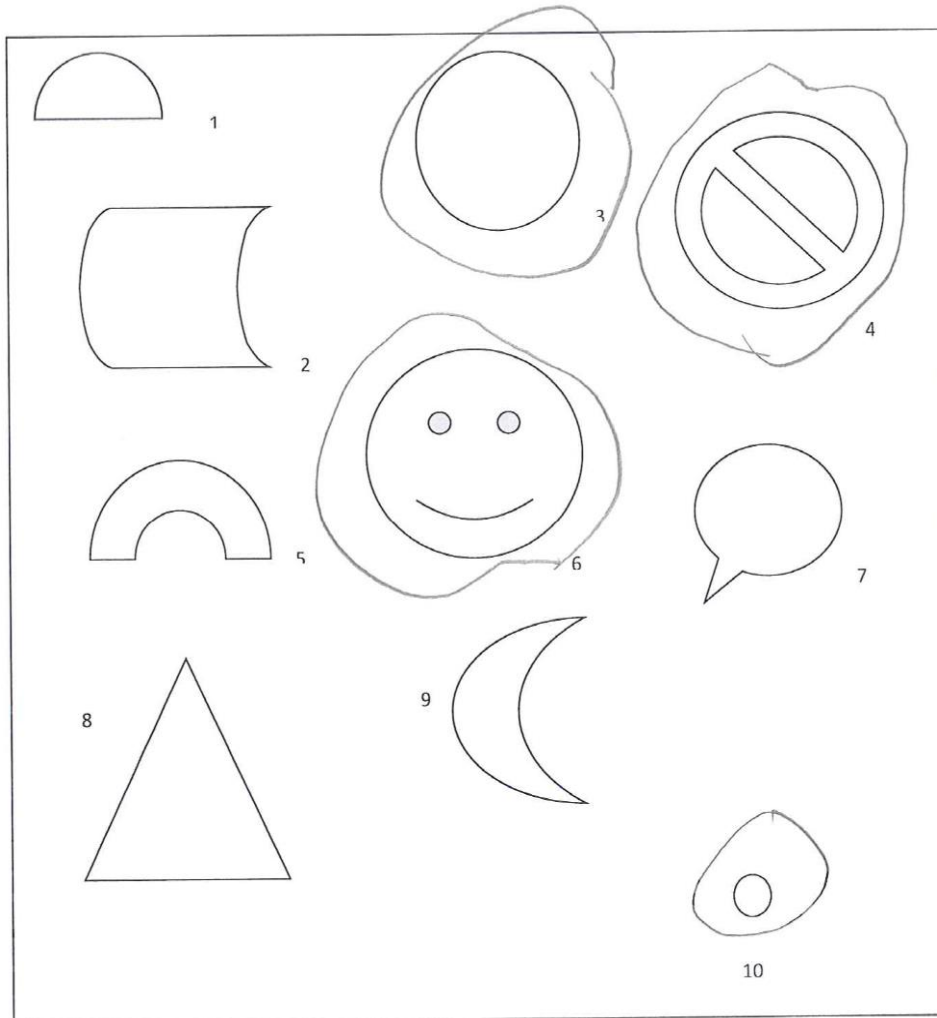

• ENCERCLA ELS QUADRATS

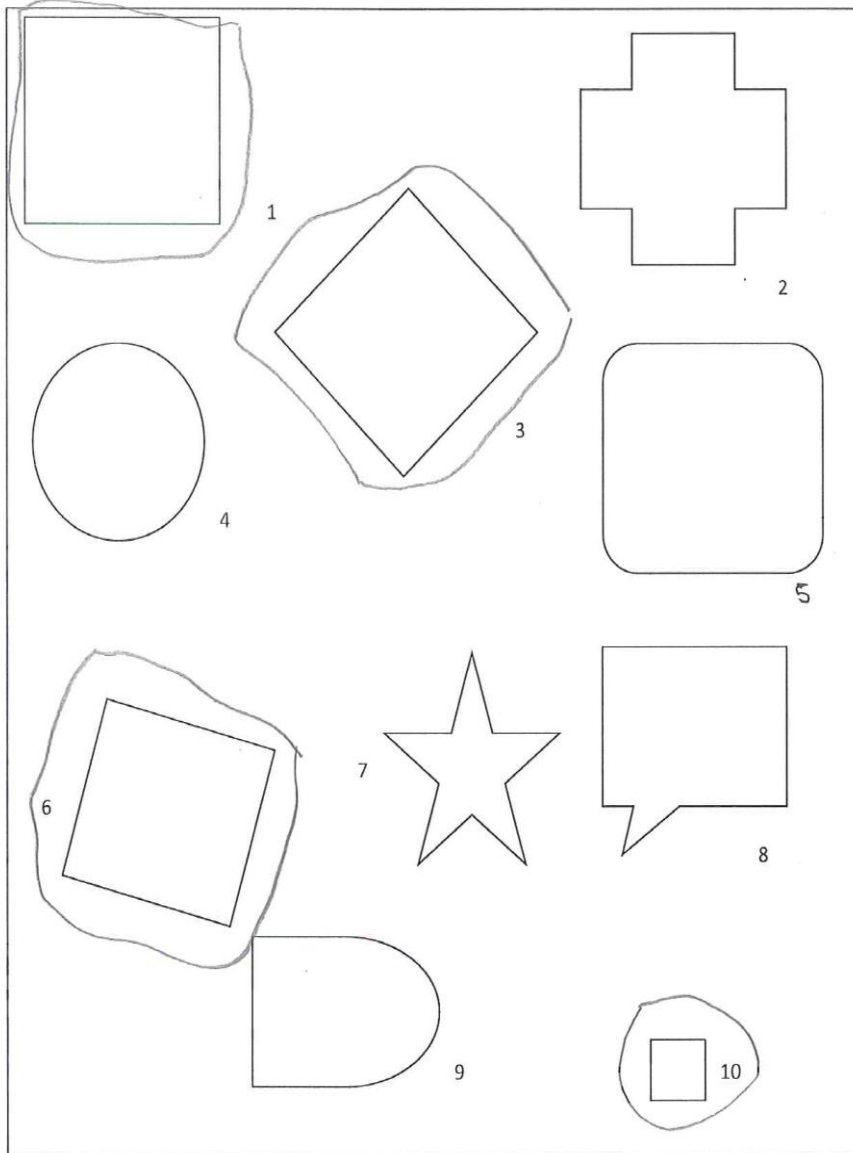

- ENCERCLA ELS RECTANGLES

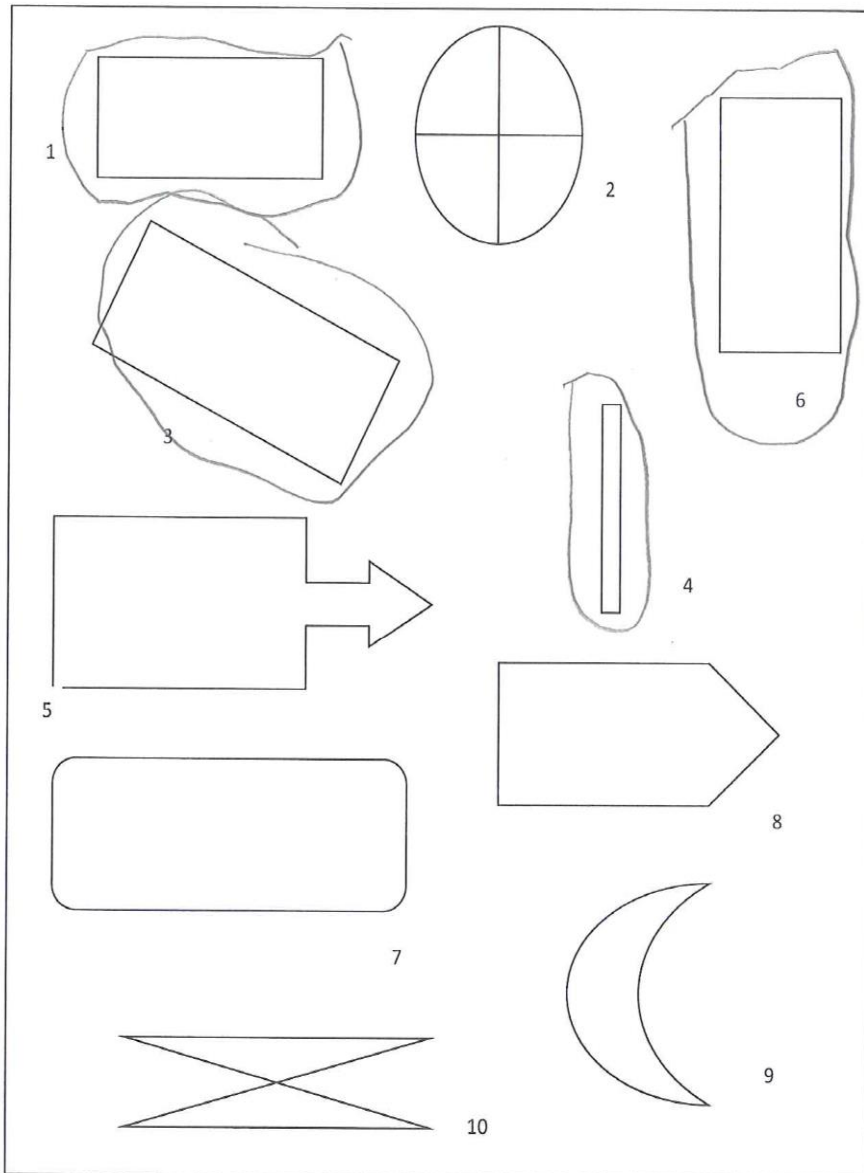

• ENCERCLA ELS TRIANGLES

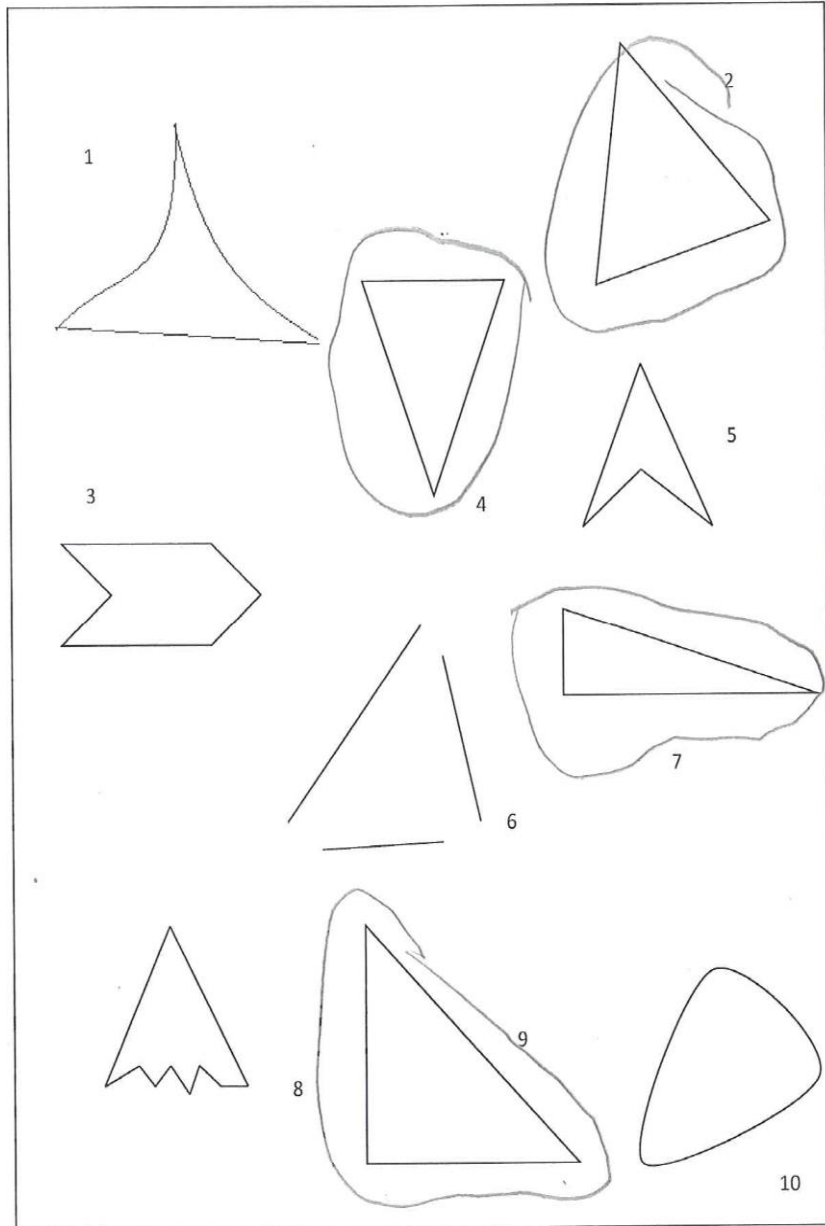



TEST PELS INFANTS DE P4B

1. DIBUIXA UN QUADRAT



2. DIBUIXA UN RECTANGLE



3. DIBUIXA UN TRIANGLE



4. DIBUIXA UN CERCLE



5. QUANTS COSTATS TENEN AQUESTES FIGURES GEOMÈTRIQUES I VÈRTEXS



Costats

4

Vèrtexs

4

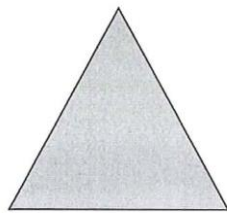

3

3



3

~~0~~ 3



4

4

6. IDENTIFICA I ENCERCLA LES FIGURES GEOMÈTRIQUES.

- ENCERCLA ELS CERCLES

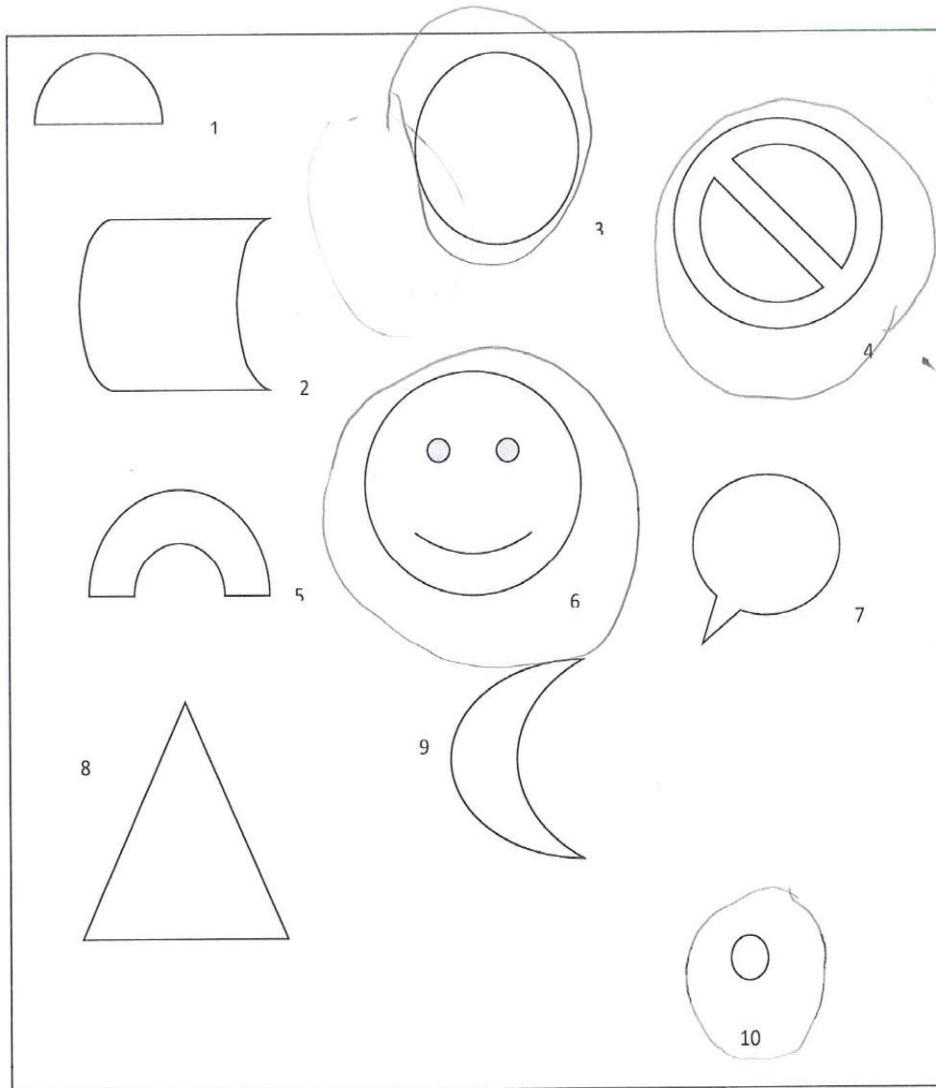

• ENCERCLA ELS QUADRATS

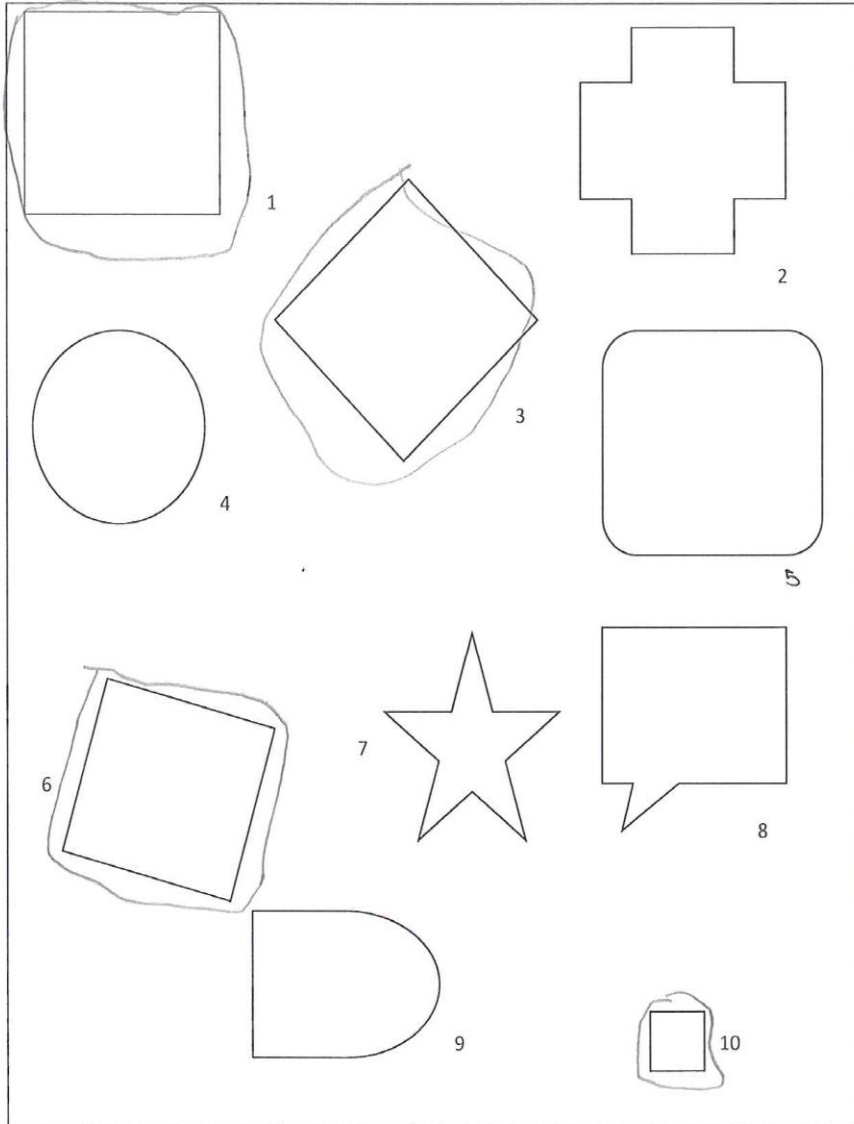

• ENCERCLA ELS RECTANGLES

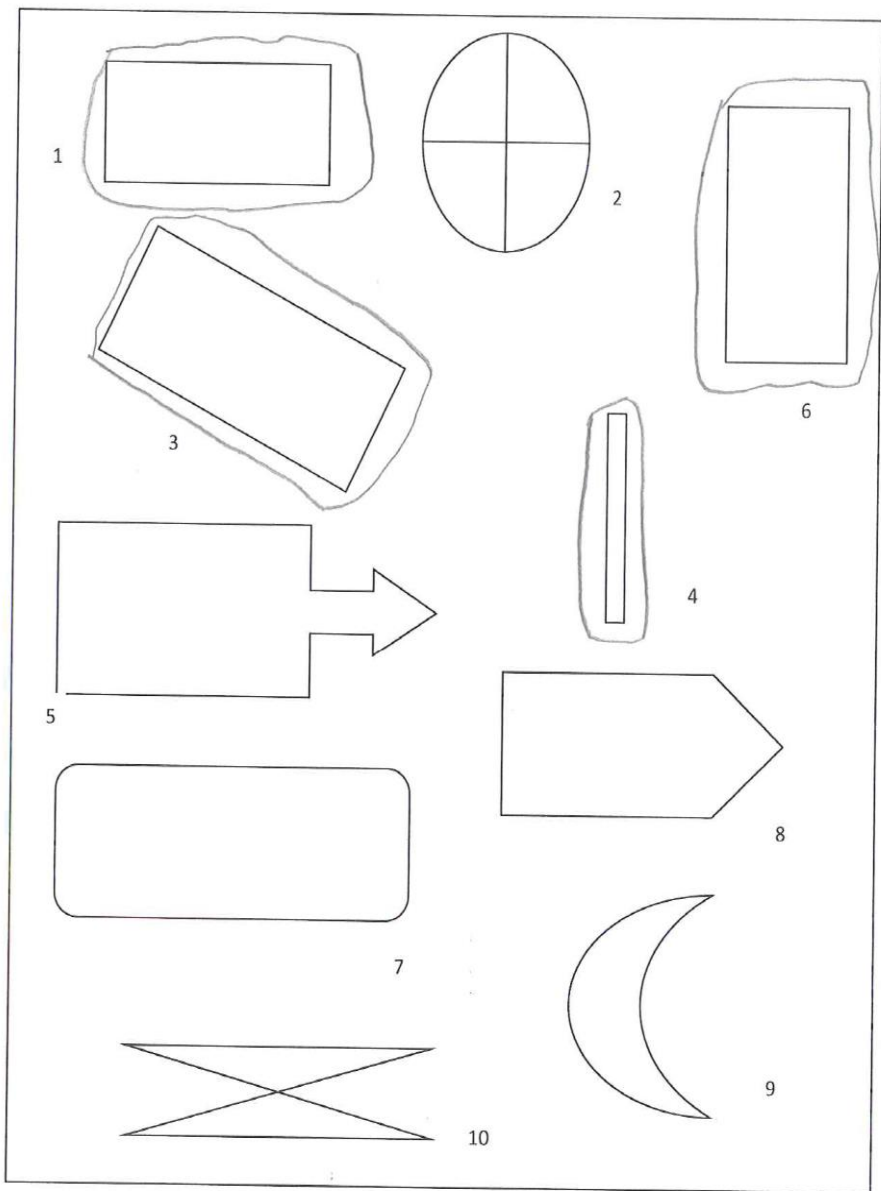

• ENCERCLA ELS TRIANGLES

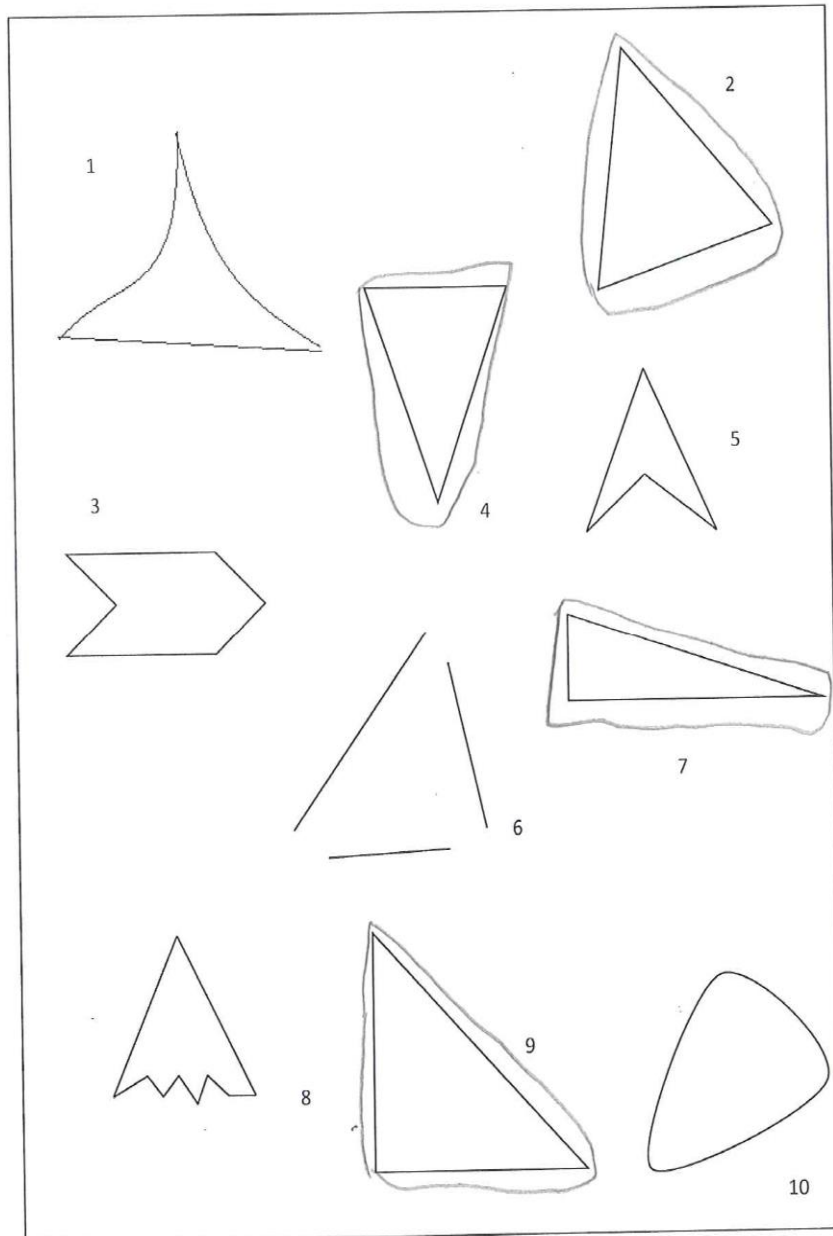

TEST PELS INFANTS DE P4B

1. DIBUIXA UN QUADRAT



2. DIBUIXA UN RECTANGLE

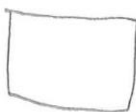

3. DIBUIXA UN TRIANGLE



4. DIBUIXA UN CERCLE



5. QUANTS COSTATS TENEN AQUESTES FIGURES GEOMÈTRIQUES I VÈRTEXS



Costats

Vèrtexs

4

4

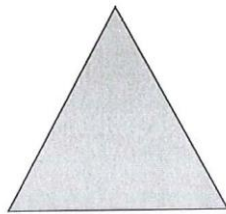

3

3



0

0



4

4



6. IDENTIFICA I ENCERCLA LES FIGURES GEOMÈTRIQUES.

- ENCERCLA ELS CERCLES

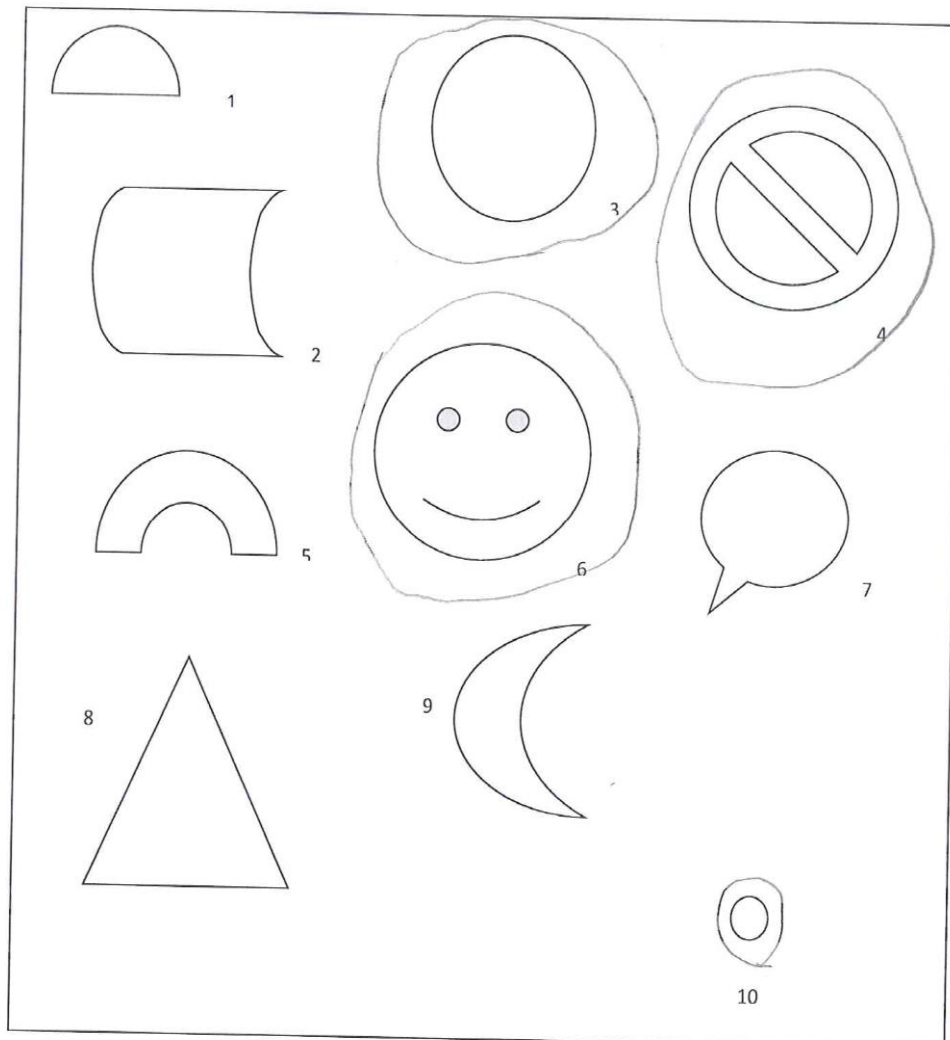

• ENCERCLA ELS QUADRATS

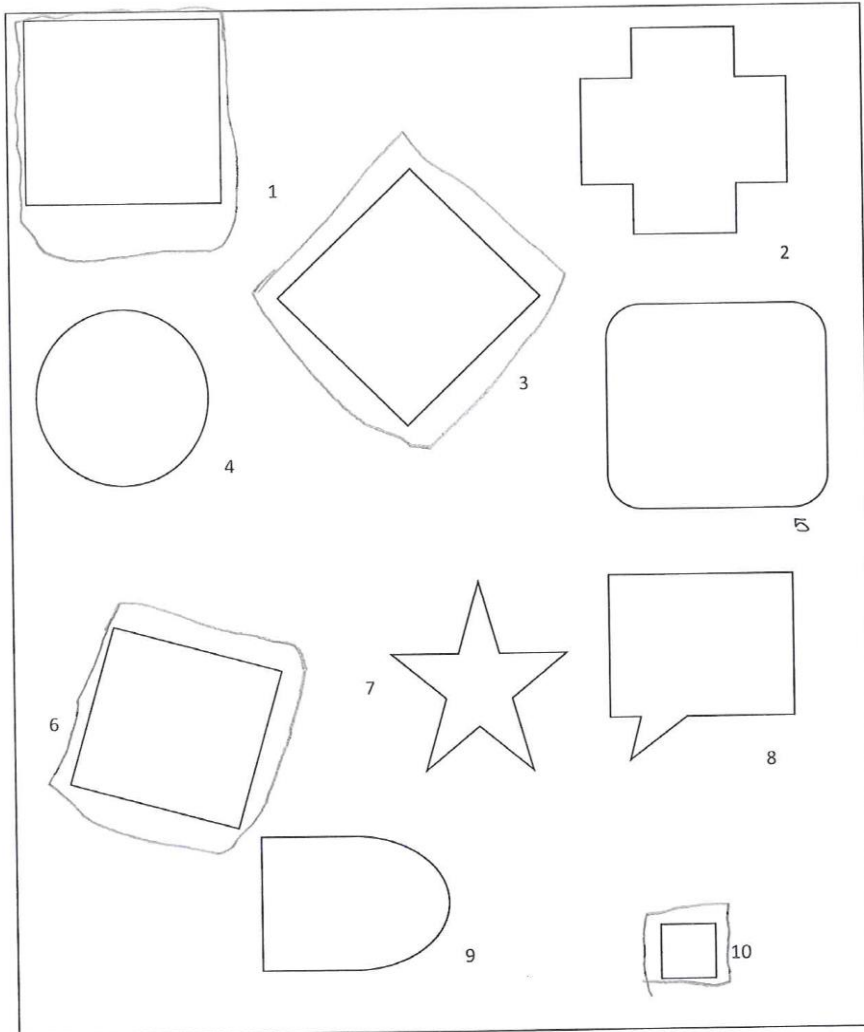

• ENCERCLA ELS RECTANGLES

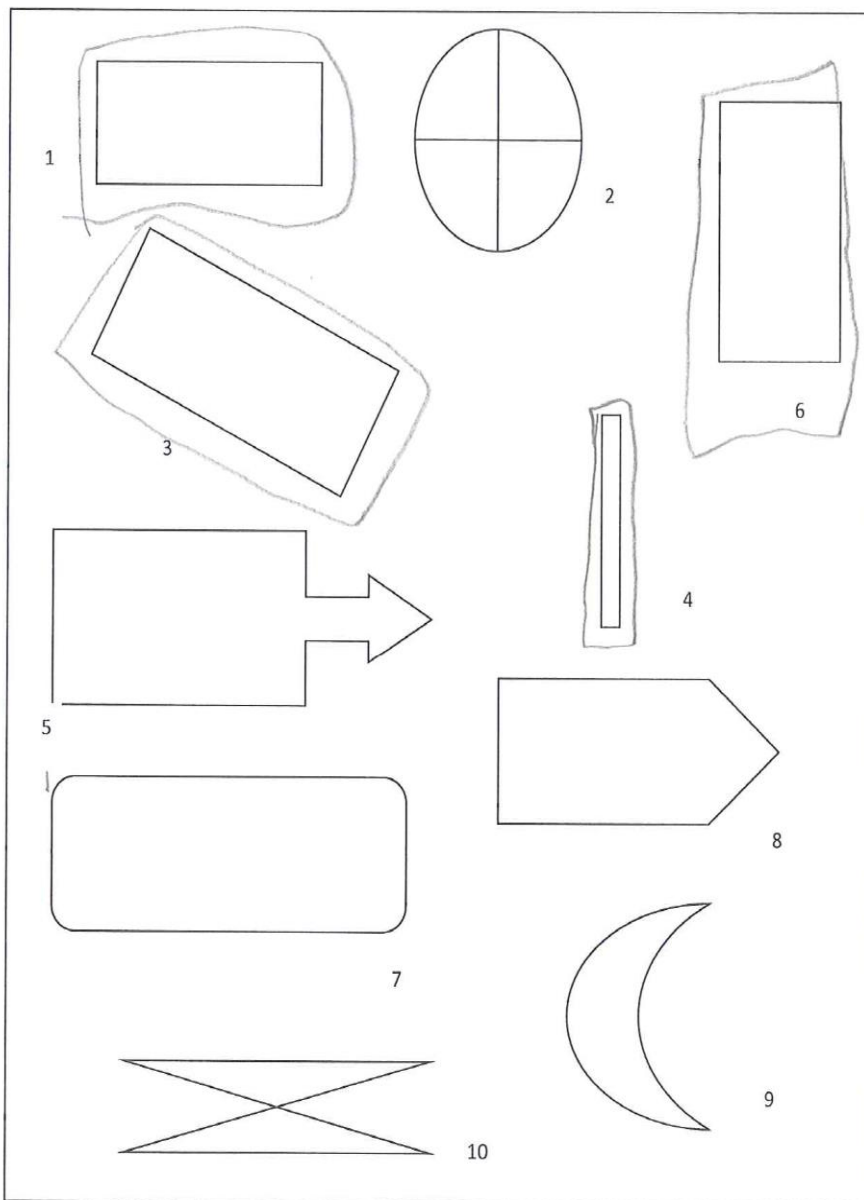

• ENCERCLA ELS TRIANGLES

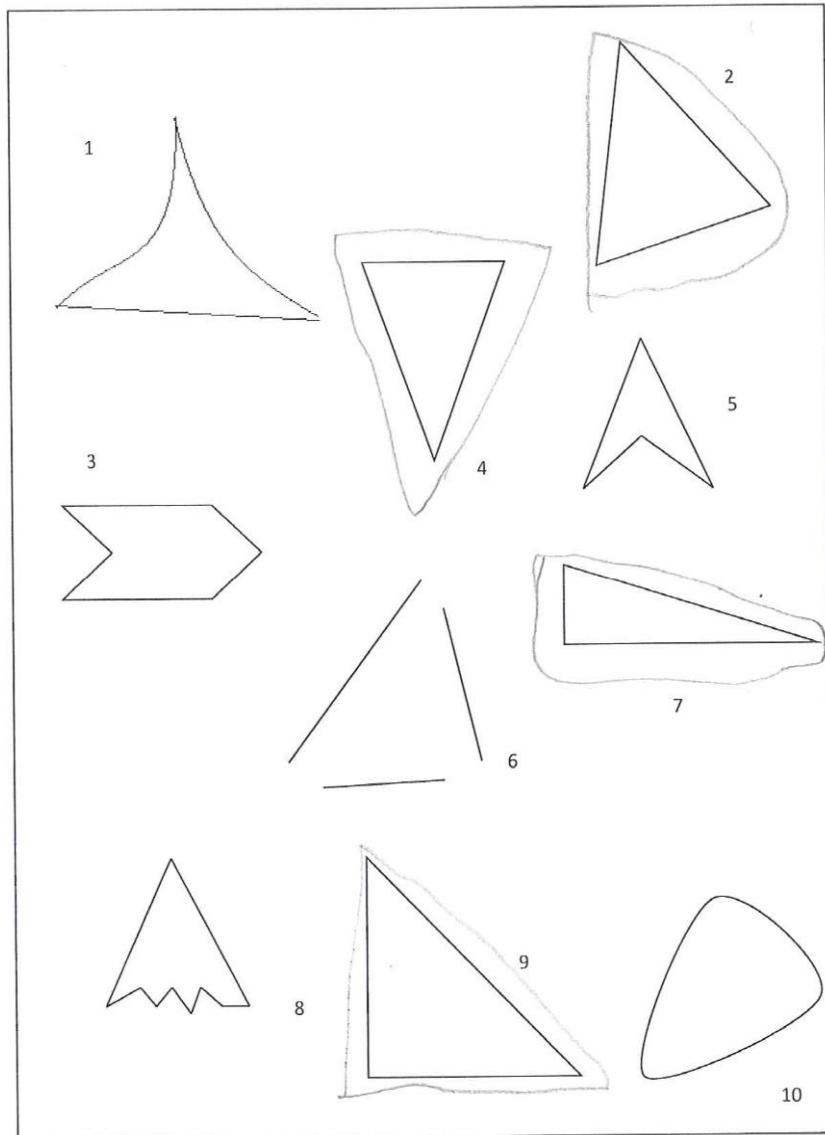



TEST PELS INFANTS DE P4B

1. DIBUIXA UN QUADRAT

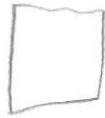

2. DIBUIXA UN RECTANGLE



3. DIBUIXA UN TRIANGLE



4. DIBUIXA UN CERCLE



5. QUANTS COSTATS TENEN AQUESTES FIGURES GEOMÈTRIQUES I VÈRTEXS



Costats

Vèrtexs.

4

4

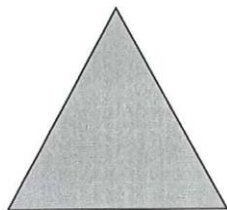

3

3

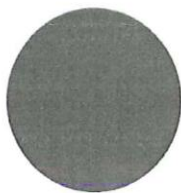

0

0



4

4

6. IDENTIFICA I ENCERCLA LES FIGURES GEOMÈTRIQUES.

- ENCERCLA ELS CERCLES

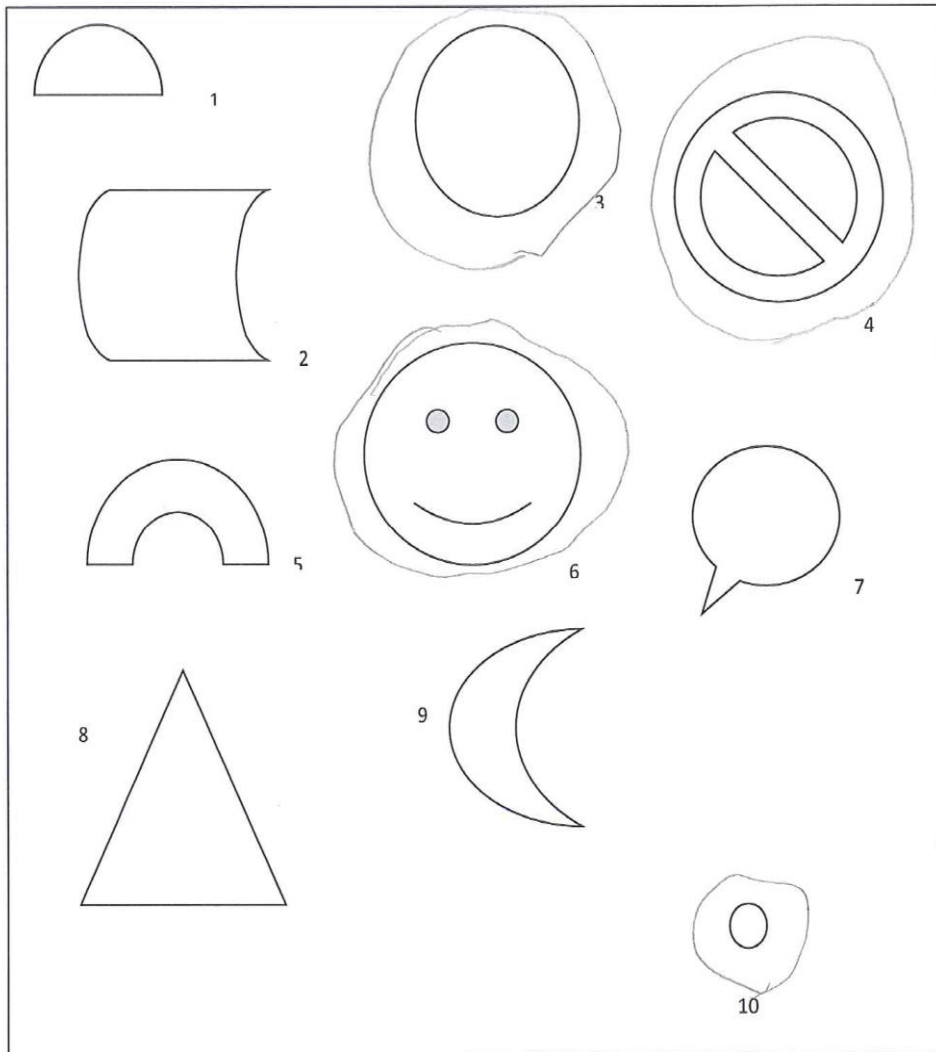

• ENCERCLA ELS QUADRATS

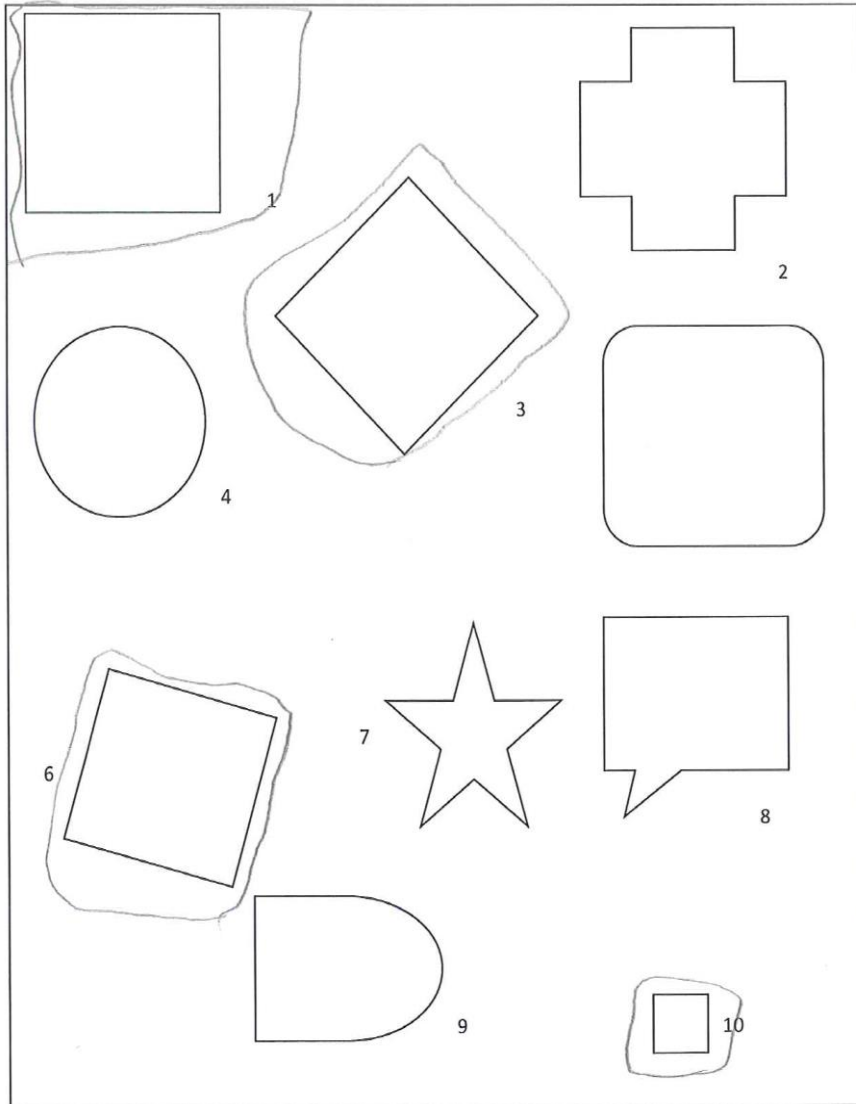

5



• ENCERCLA ELS RECTANGLES

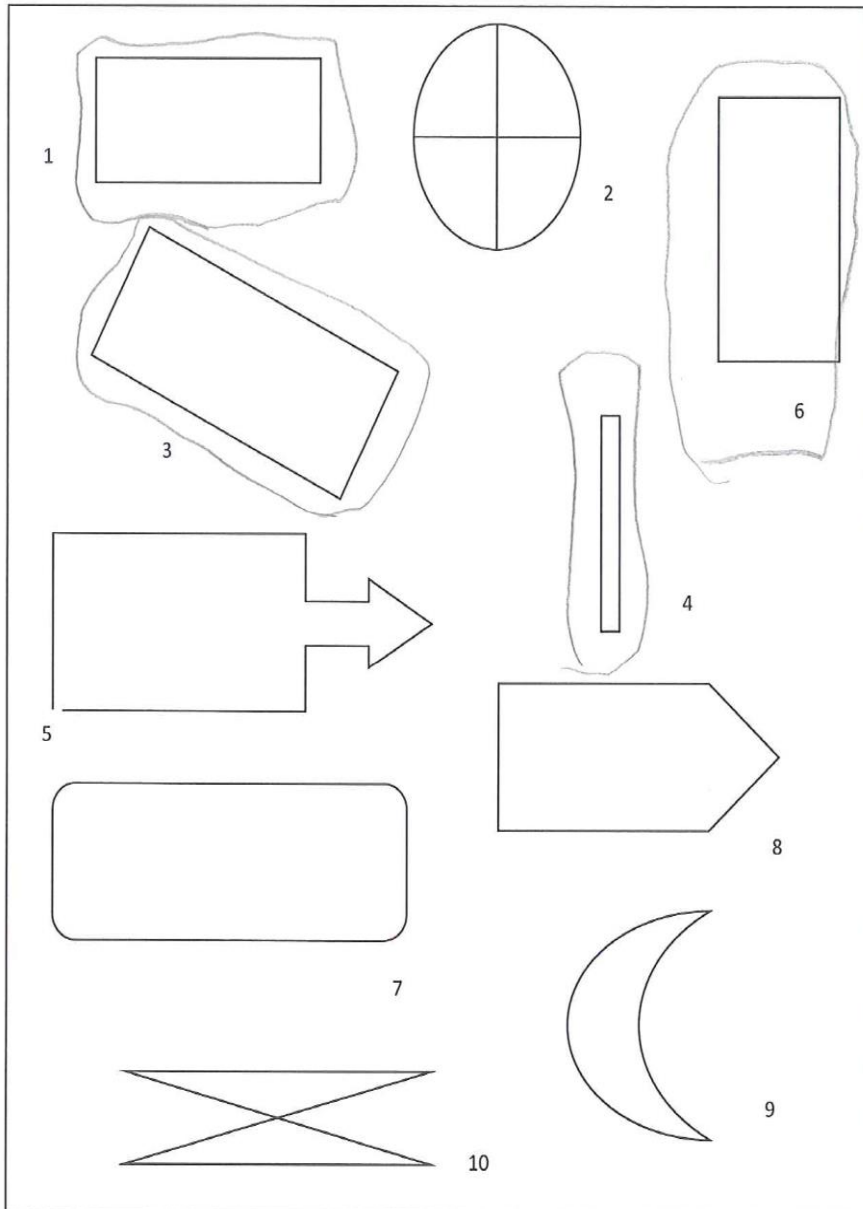

• ENCERCLA ELS TRIANGLES

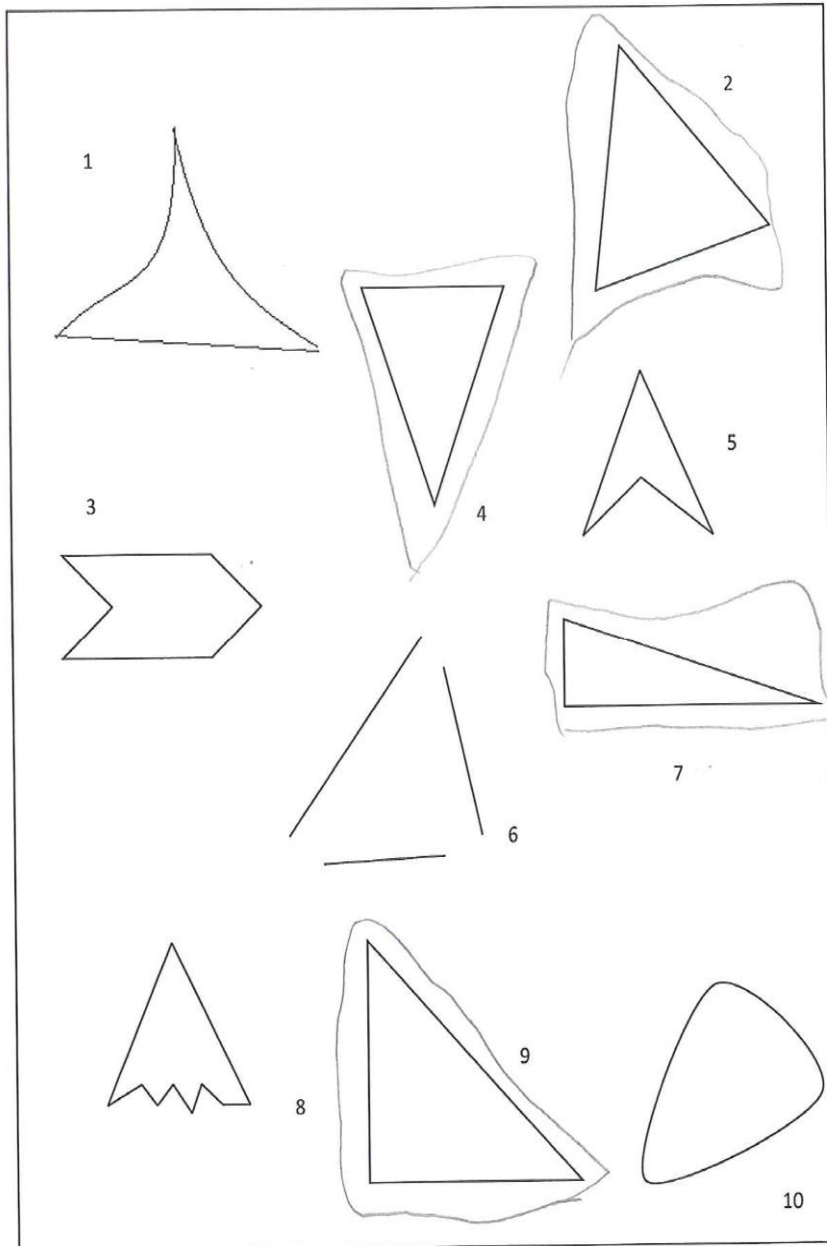

TEST PELS INFANTS DE P4B

1. DIBUIXA UN QUADRAT



2. DIBUIXA UN RECTANGLE



3. DIBUIXA UN TRIANGLE



4. DIBUIXA UN CERCLE



5. QUANTS COSTATS TENEN AQUESTES FIGURES GEOMÈTRIQUES I VÈRTEXS



Costats

4

Vèrtexs

4

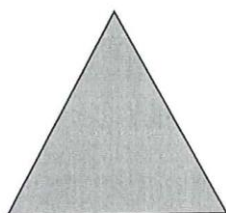

3

3



0

0



4

4

6. IDENTIFICA I ENCERCLA LES FIGURES GEOMÈTRIQUES.

- ENCERCLA ELS CERCLES

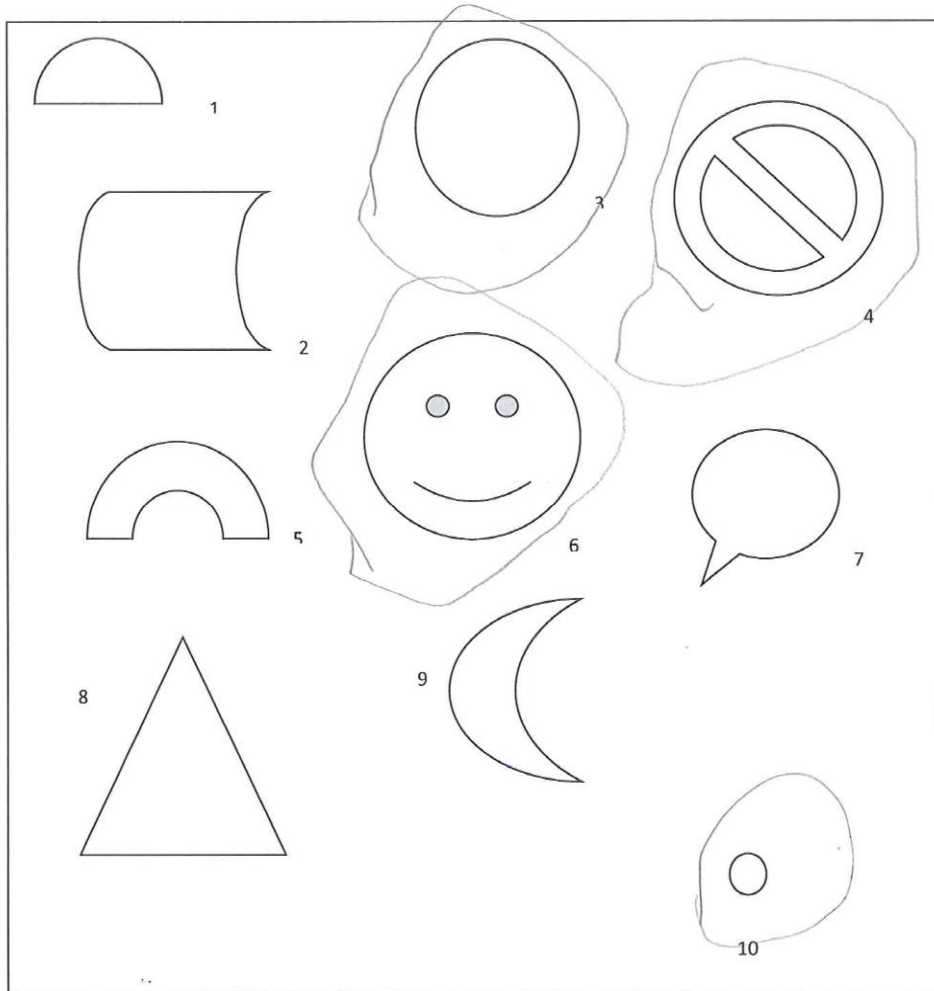

• ENCERCLA ELS QUADRATS

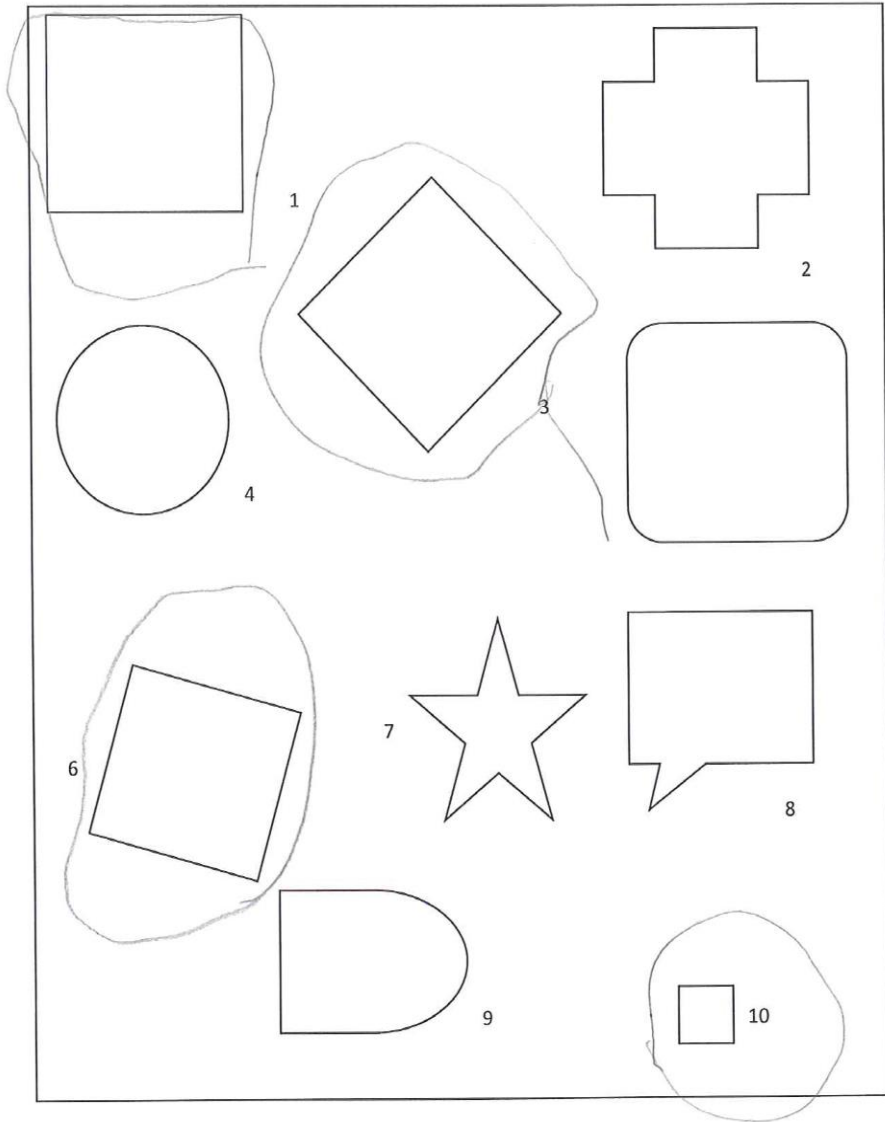

• ENCERCLA ELS RECTANGLES

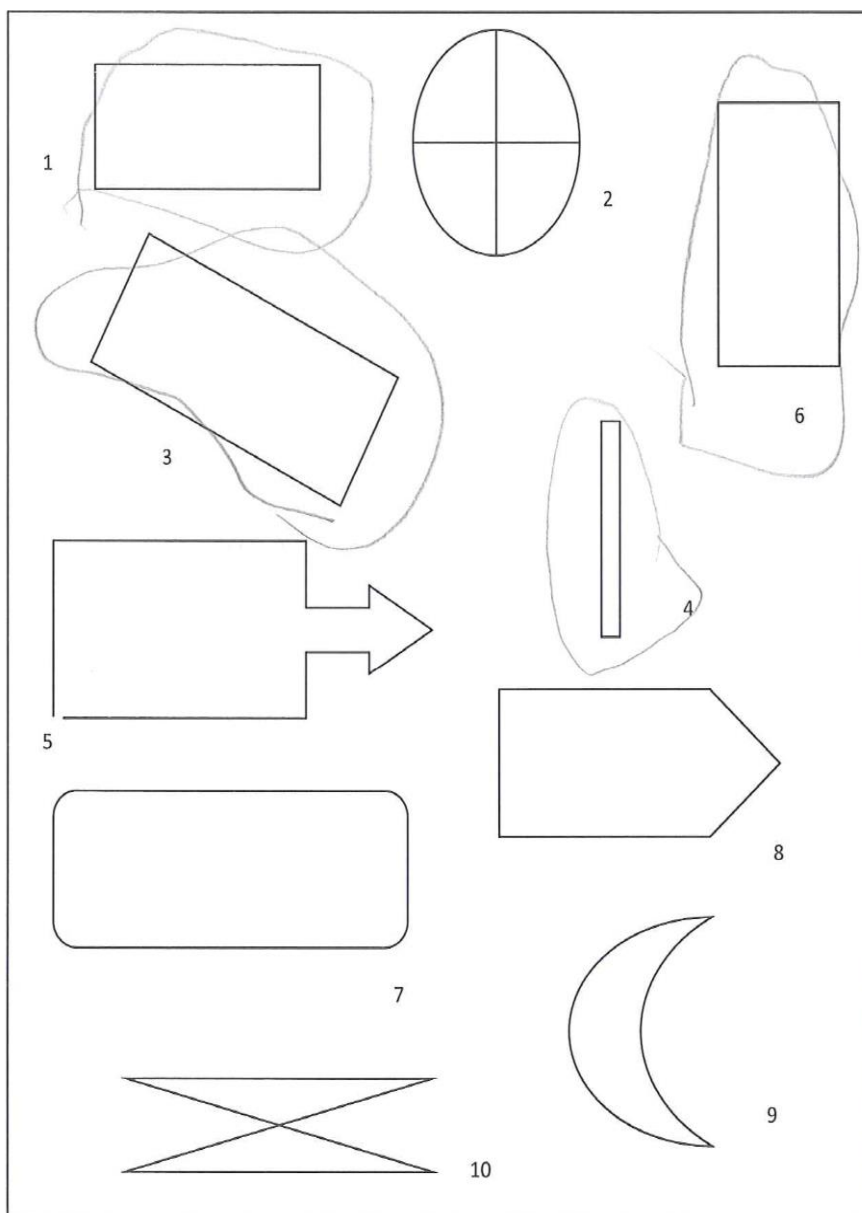

• ENCERCLA ELS TRIANGLES

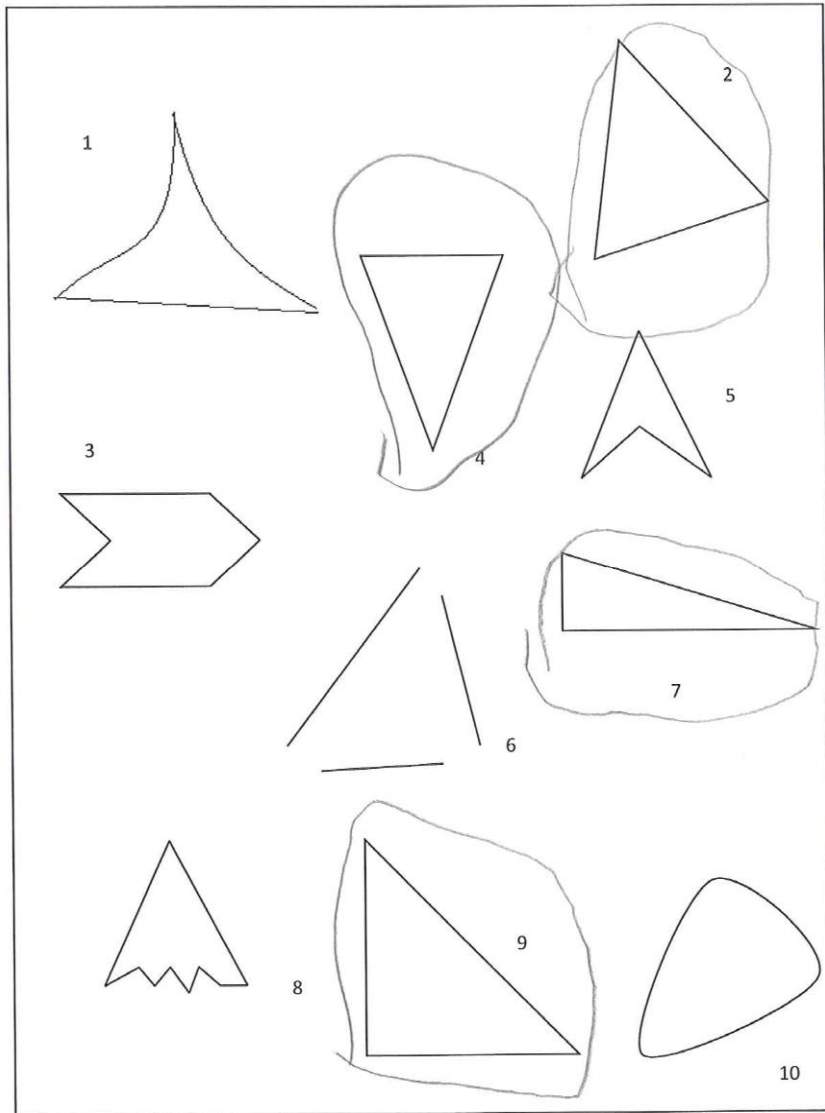



TEST PELS INFANTS DE P4B

1. DIBUIXA UN QUADRAT



2. DIBUIXA UN RECTANGLE

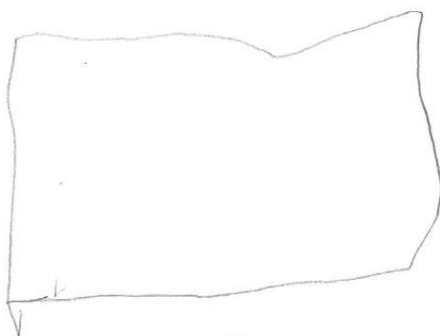

3. DIBUIXA UN TRIANGLE

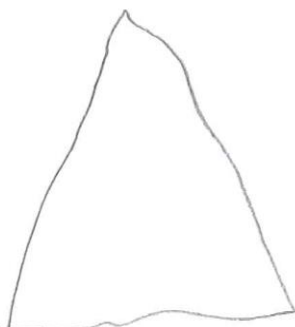

4. DIBUIXA UN CERCLE



5. QUANTS COSTATS TENEN AQUESTES FIGURES GEOMÈTRIQUES I VÈRTEXS



costats

Vèrtexs

4

4

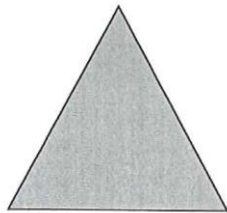

3

3



0

0



4

4

6. IDENTIFICA I ENCERCLA LES FIGURES GEOMÈTRIQUES.

- ENCERCLA ELS CERCLES

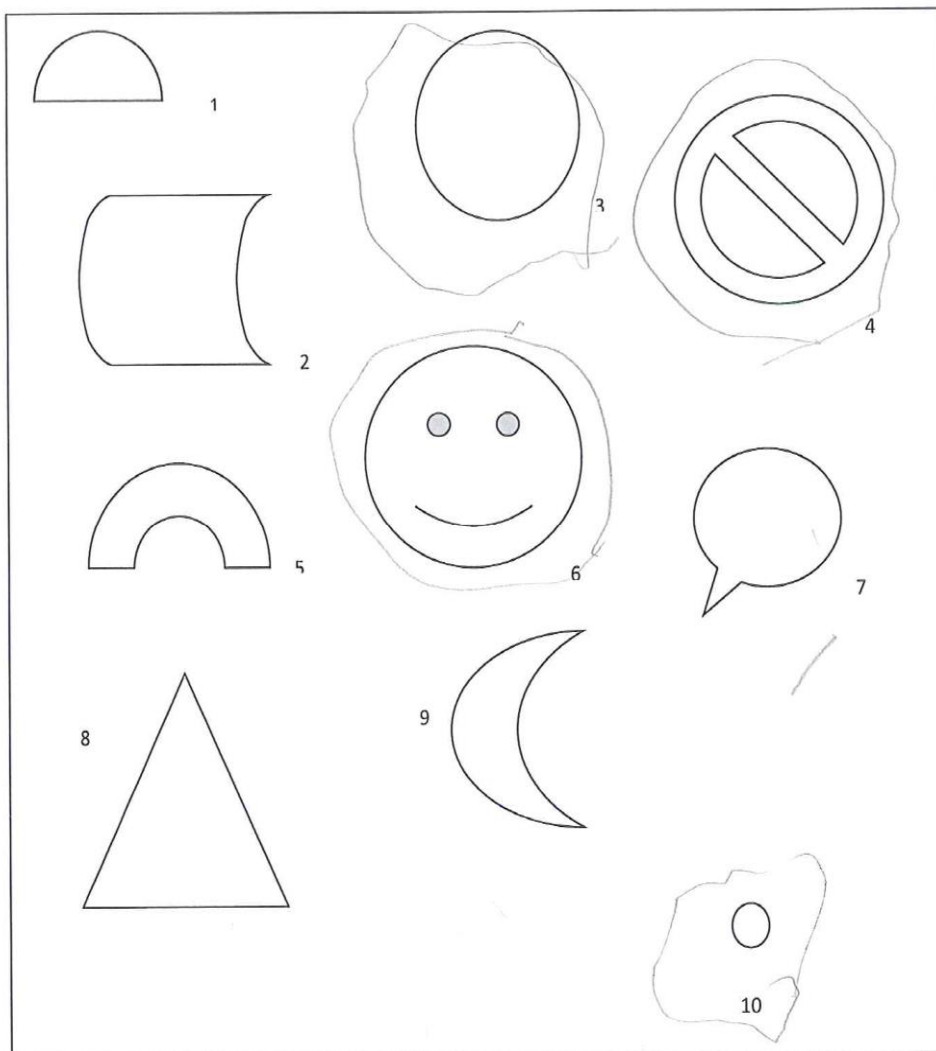

• ENCERCLA ELS QUADRATS

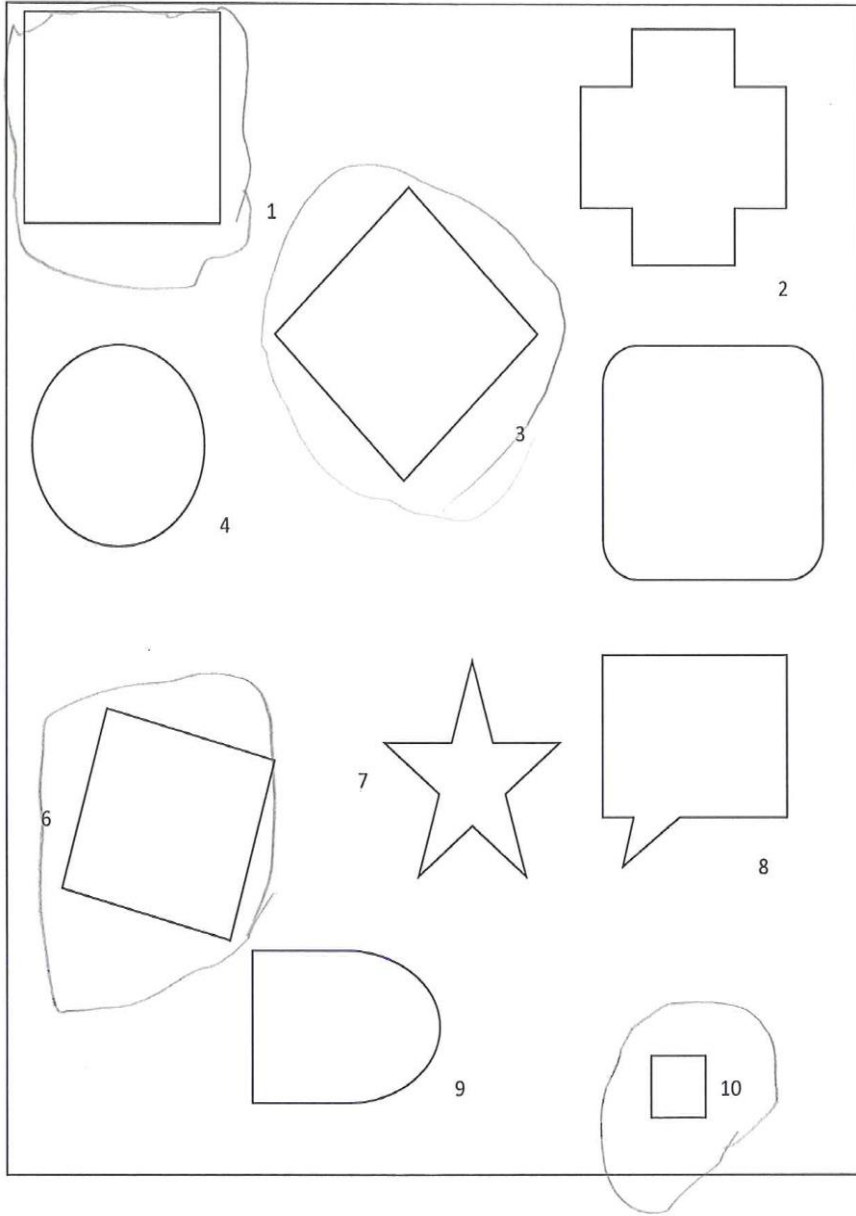

• ENCERCLA ELS RECTANGLES

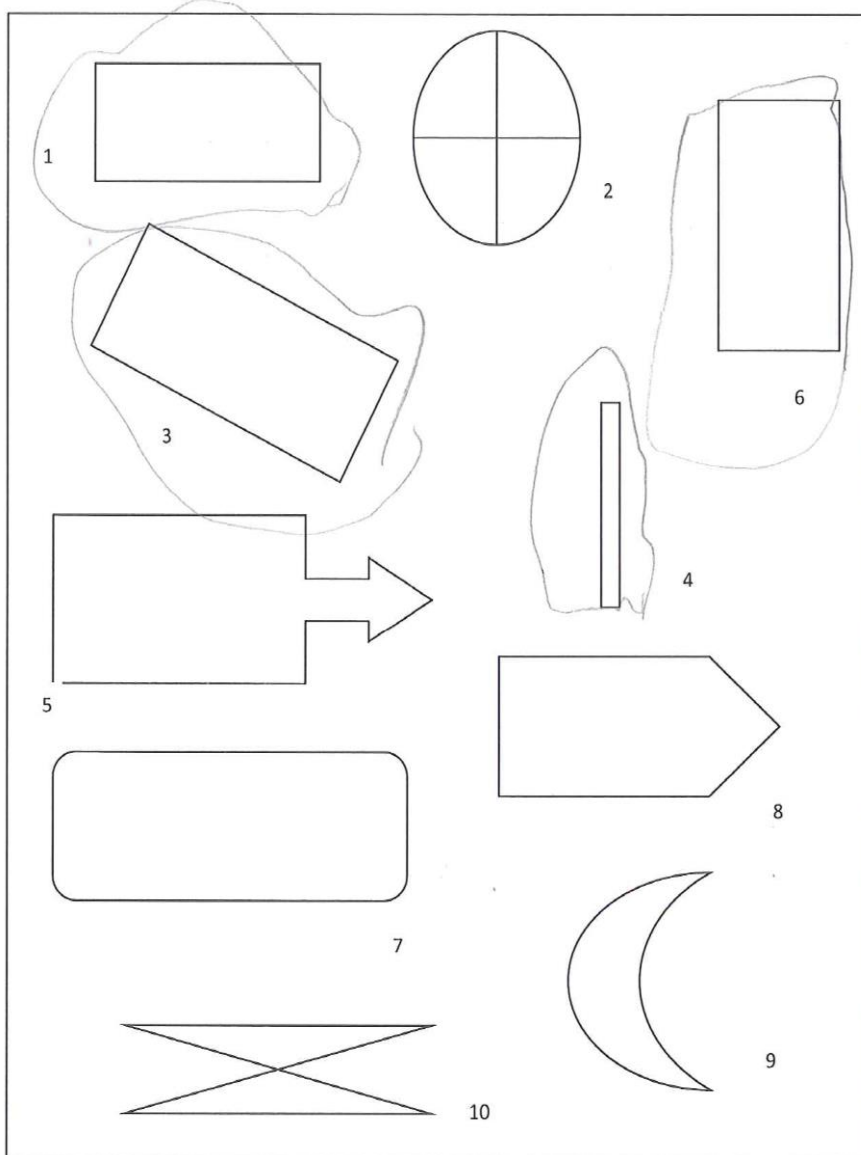

• ENCERCLA ELS TRIANGLES

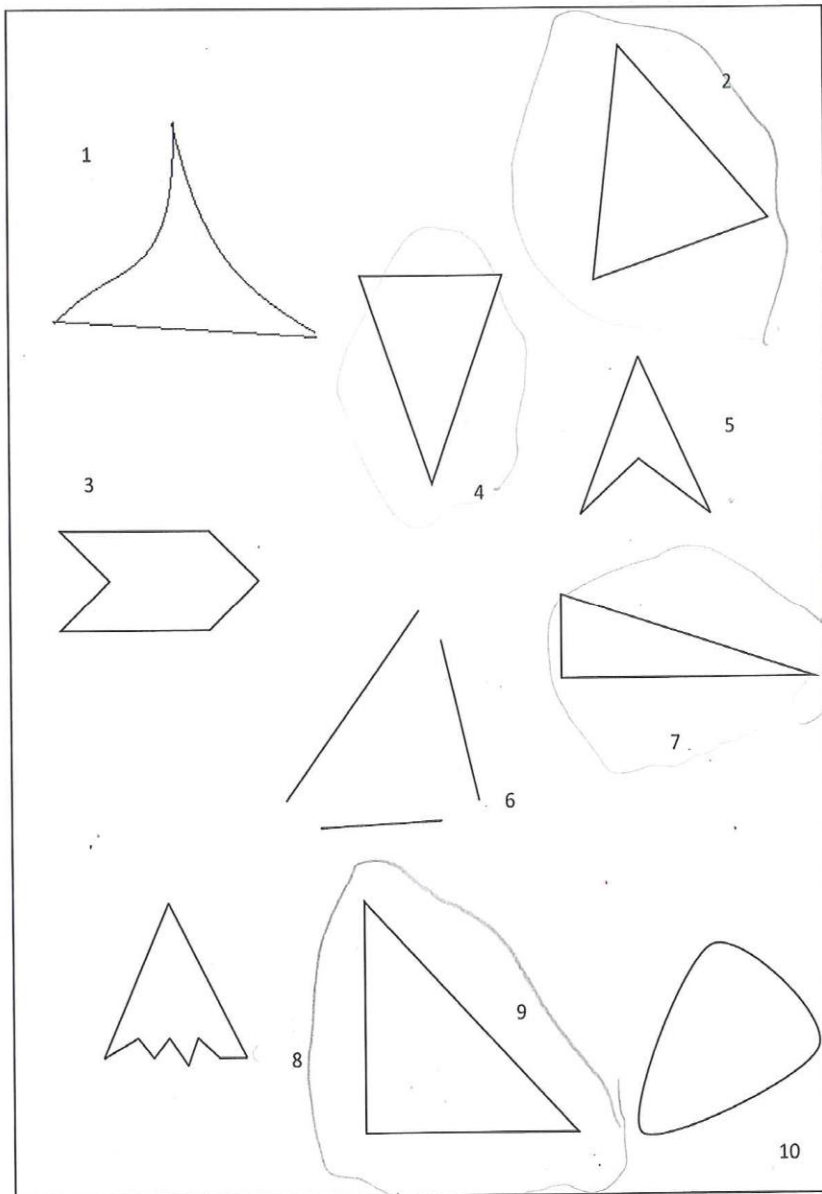

TEST PELS INFANTS DE P4B

1. DIBUIXA UN QUADRAT



2. DIBUIXA UN RECTANGLE



3. DIBUIXA UN TRIANGLE



4. DIBUIXA UN CERCLE



5. QUANTS COSTATS TENEN AQUESTES FIGURES GEOMÈTRIQUES I VÈRTEXS



Costats

Vèrtexs

4

4

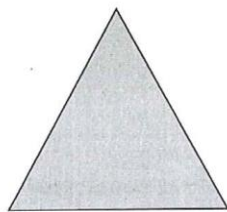

3

3



0

0



4

4



6. IDENTIFICA I ENCERCLA LES FIGURES GEOMÈTRIQUES.

- ENCERCLA ELS CERCLES

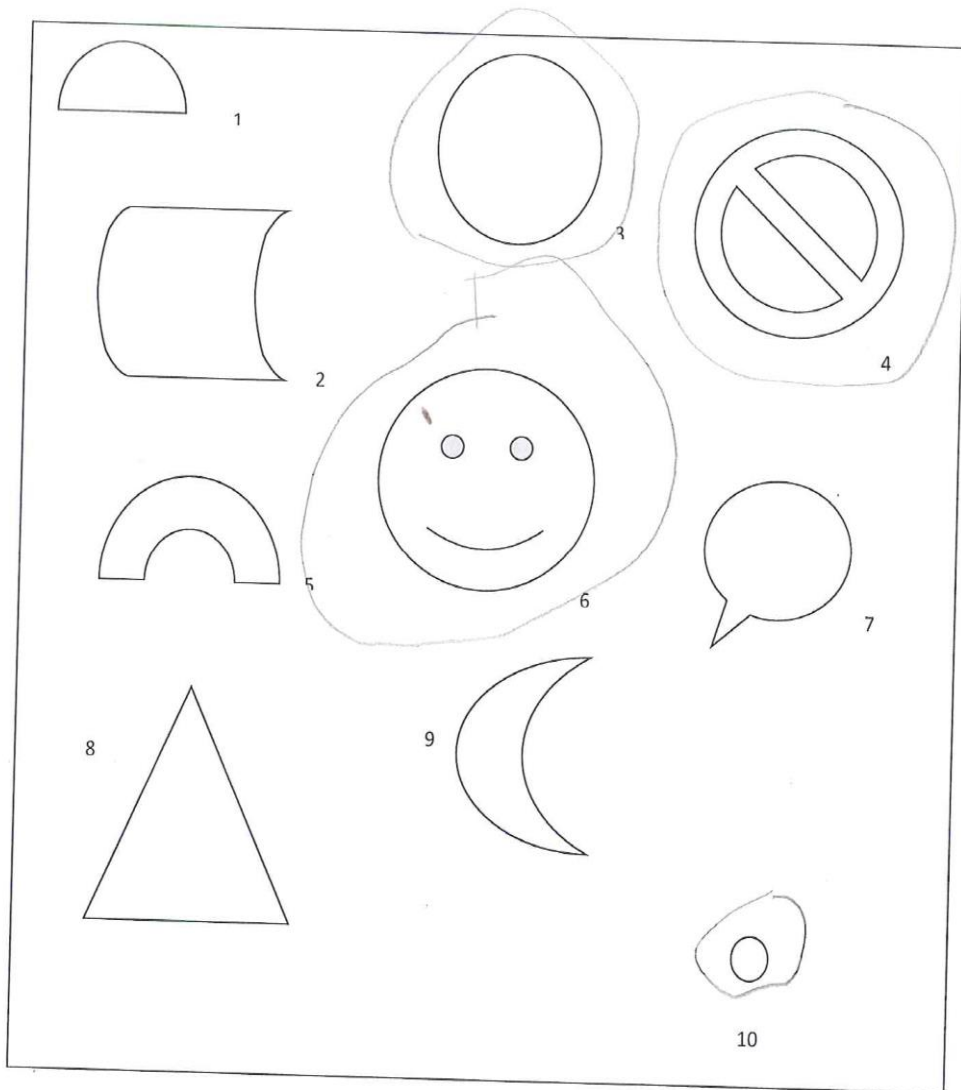

• ENCERCLA ELS QUADRATS

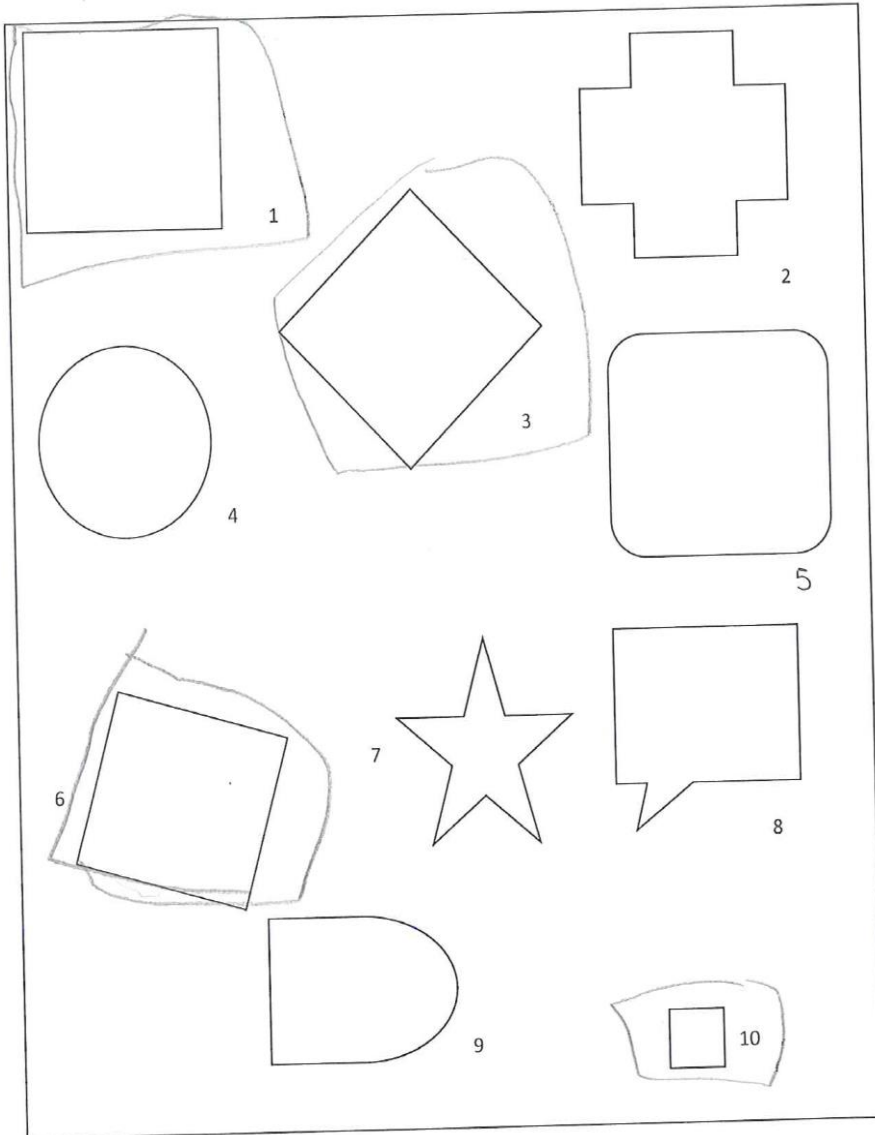

• ENCERCLA ELS RECTANGLES

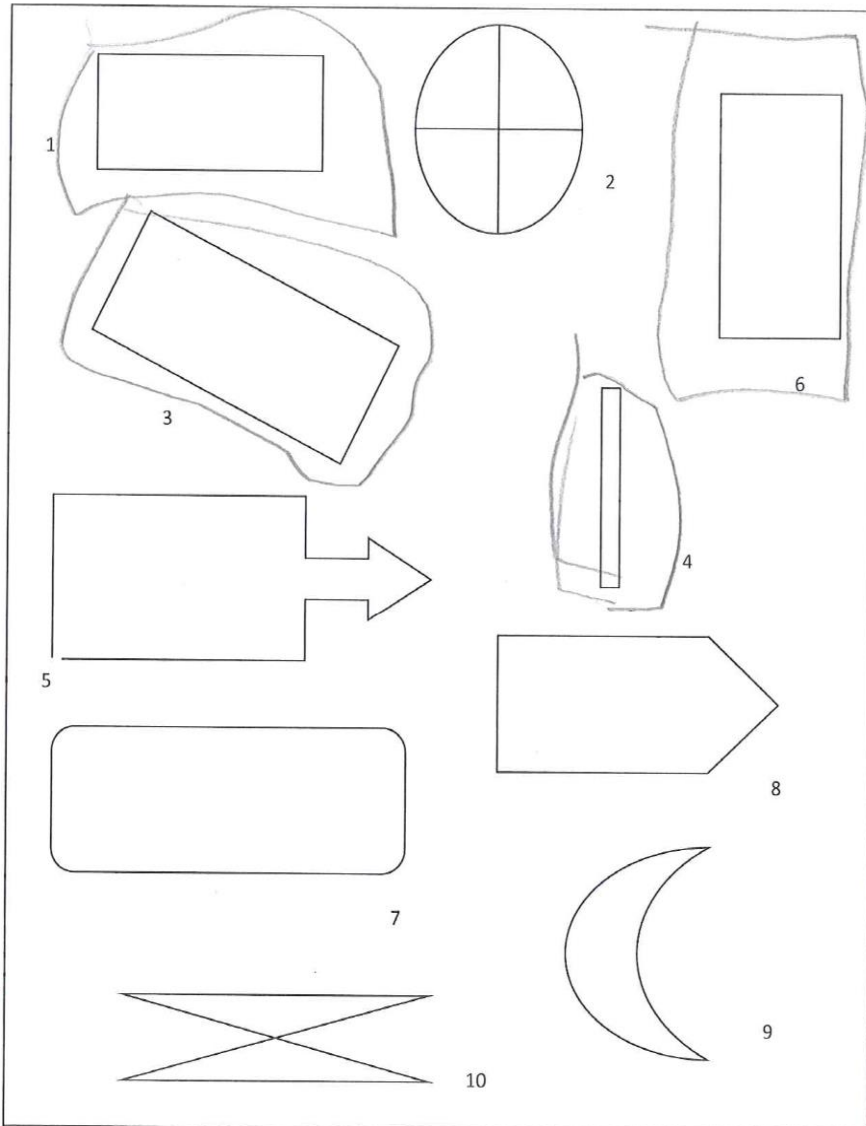

• ENCERCLA ELS TRIANGLES

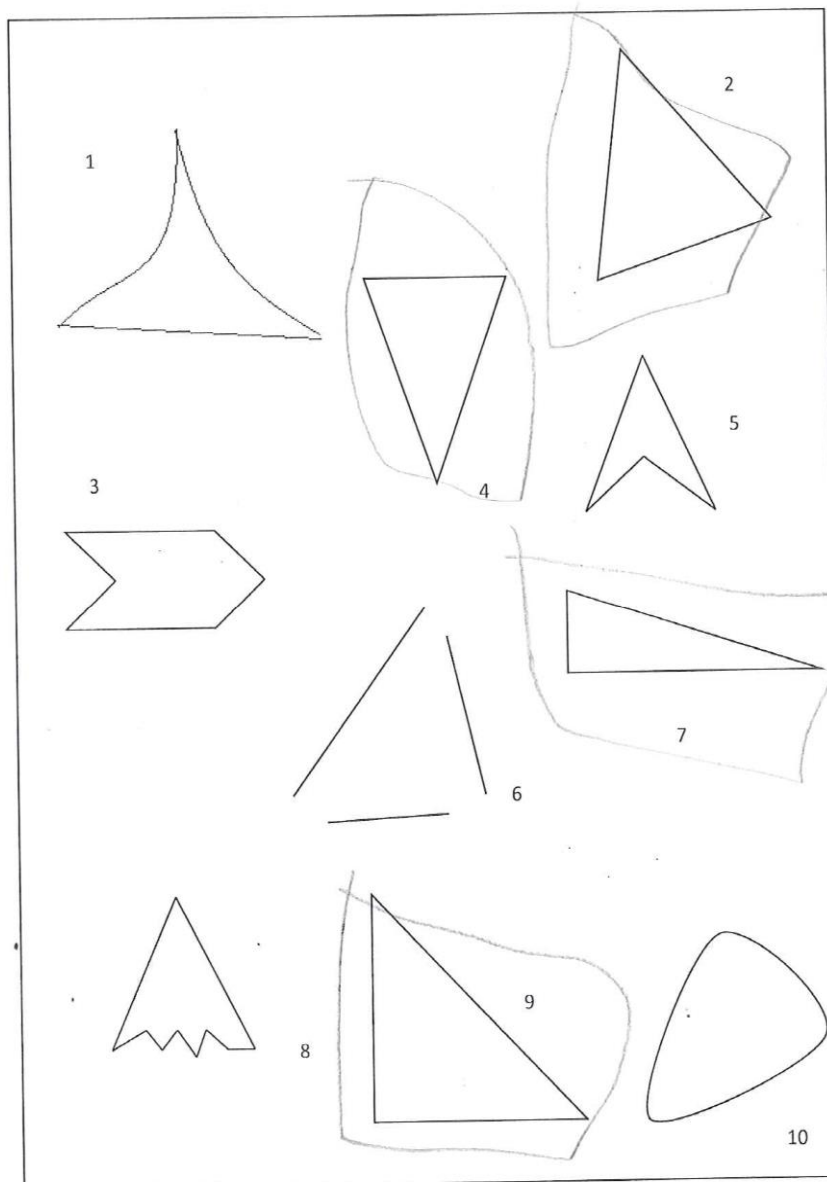

TEST PELS INFANTS DE P4B

1. DIBUIXA UN QUADRAT



2. DIBUIXA UN RECTANGLE

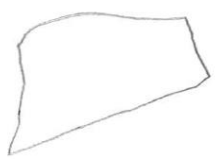

3. DIBUIXA UN TRIANGLE



4. DIBUIXA UN CERCLE



5. QUANTS COSTATS TENEN AQUESTES FIGURES GEOMÈTRIQUES I VÈRTEXS

Costats

Vèrtexs.



4

4

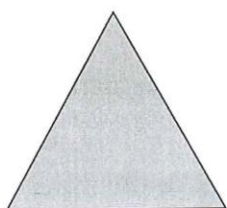

3

3



0

0



4

4

6. IDENTIFICA I ENCERCLA LES FIGURES GEOMÈTRIQUES.

- ENCERCLA ELS CERCLES

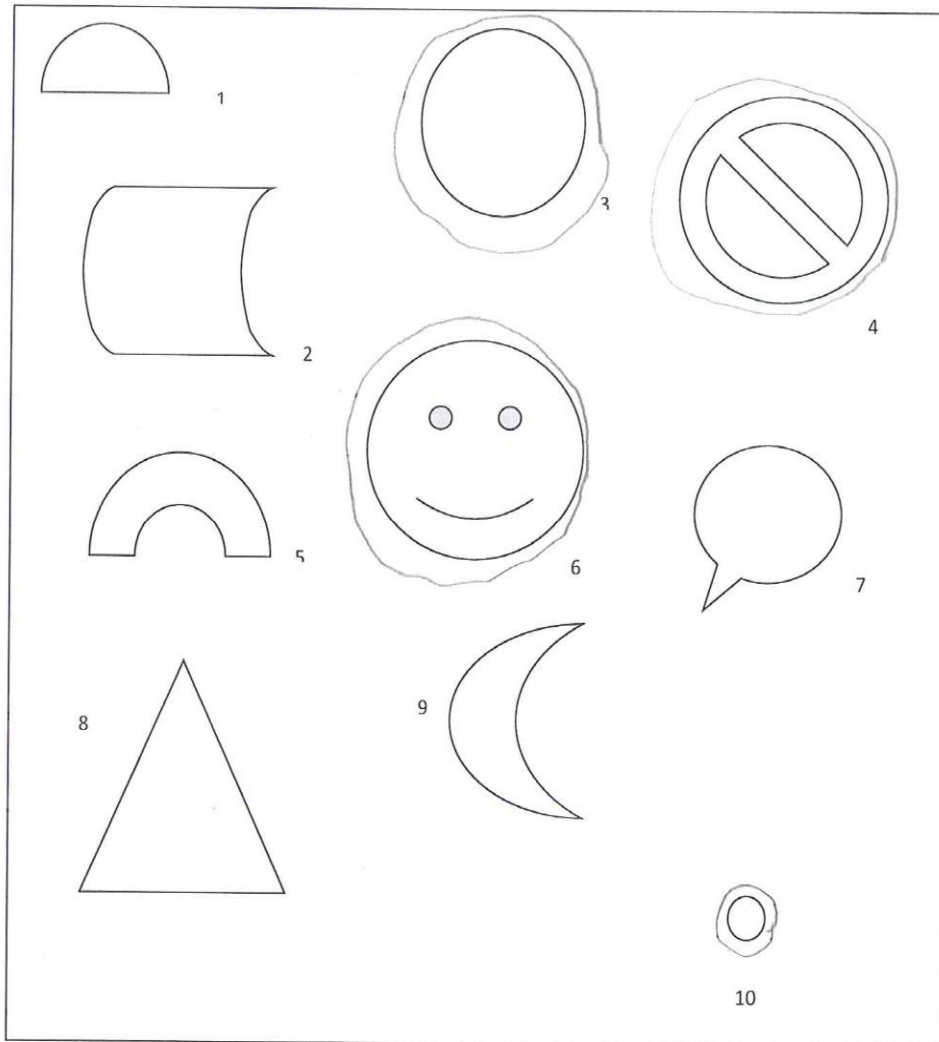

• ENCERCLA ELS QUADRATS

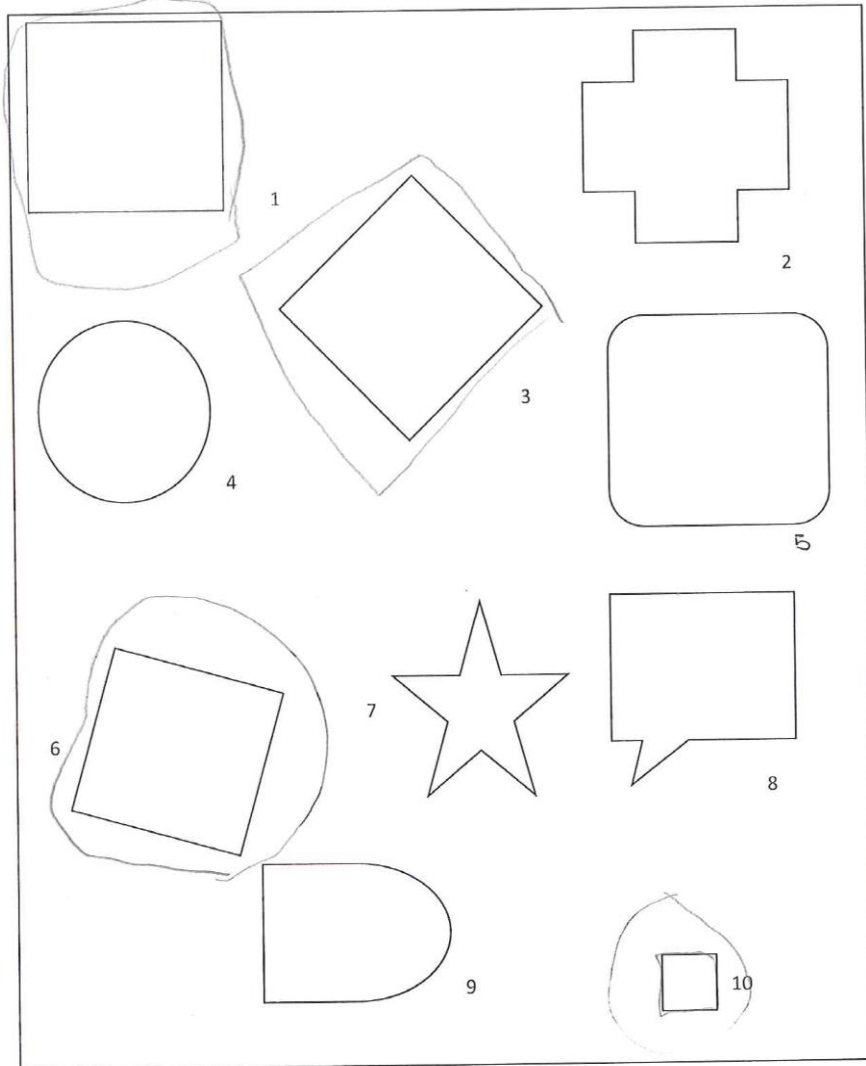



- ENCERCLA ELS RECTANGLES

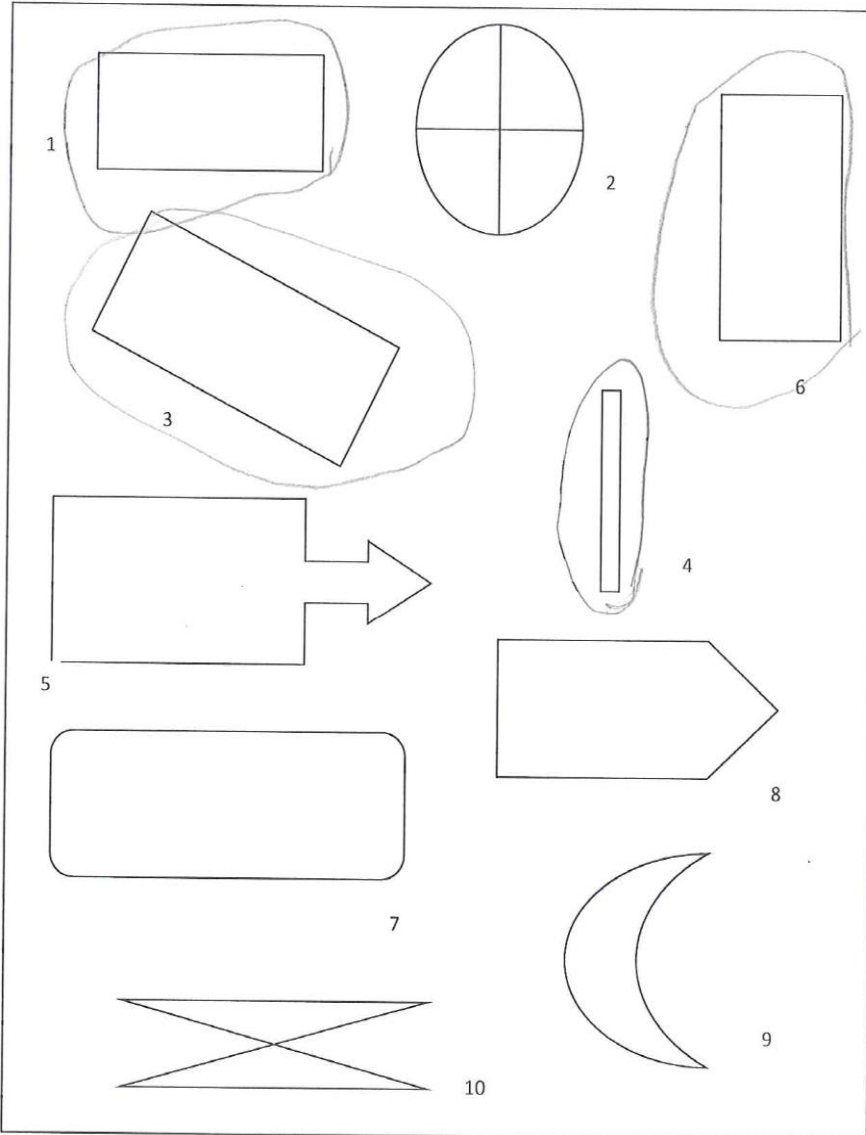

• ENCERCLA ELS TRIANGLES

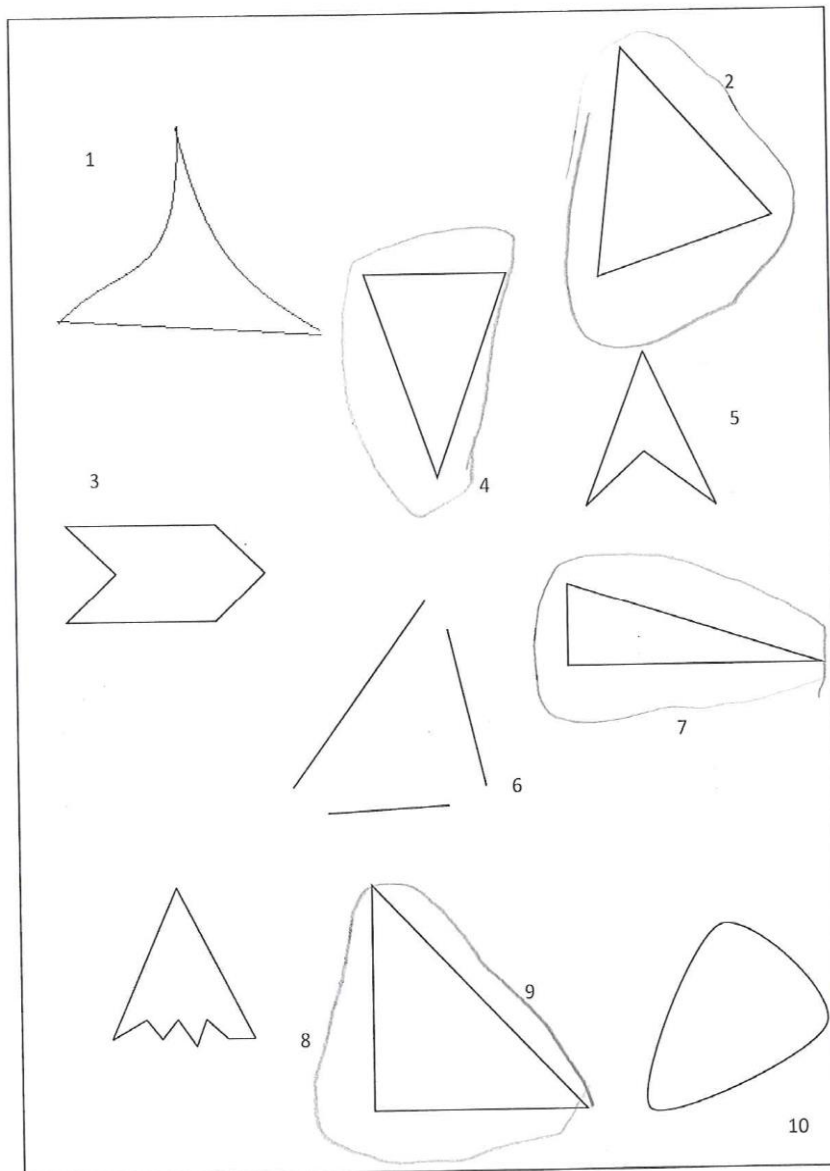

TEST PELS INFANTS DE P4B

1. DIBUIXA UN QUADRAT



2. DIBUIXA UN RECTANGLE



3. DIBUIXA UN TRIANGLE



4. DIBUIXA UN CERCLE



5. QUANTS COSTATS TENEN AQUESTES FIGURES GEOMÈTRIQUES I VÈRTEXS



Costats

Vèrtexs

4

4

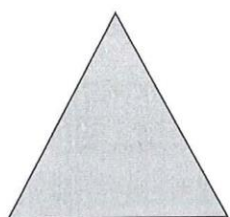

3

3



3

3



4

4

6. IDENTIFICA I ENCERCLA LES FIGURES GEOMÈTRIQUES.

- ENCERCLA ELS CERCLES

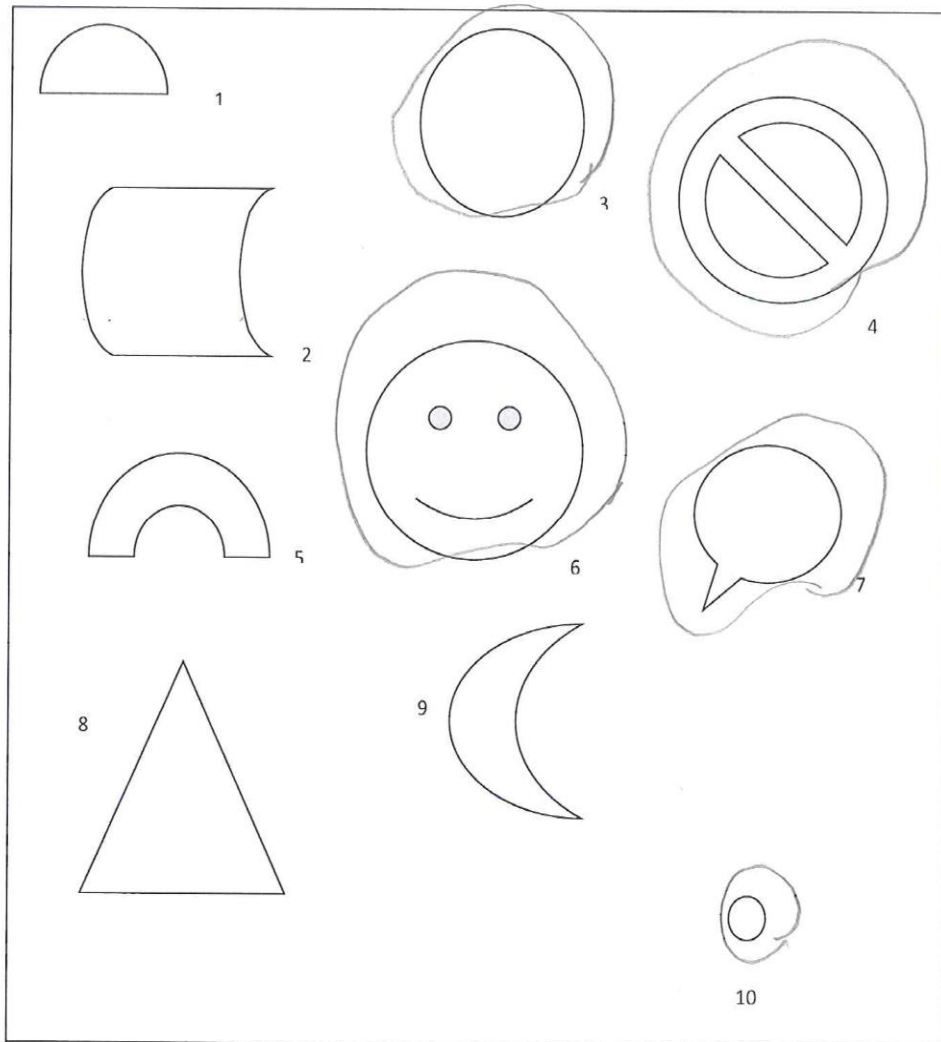

• ENCERCLA ELS QUADRATS

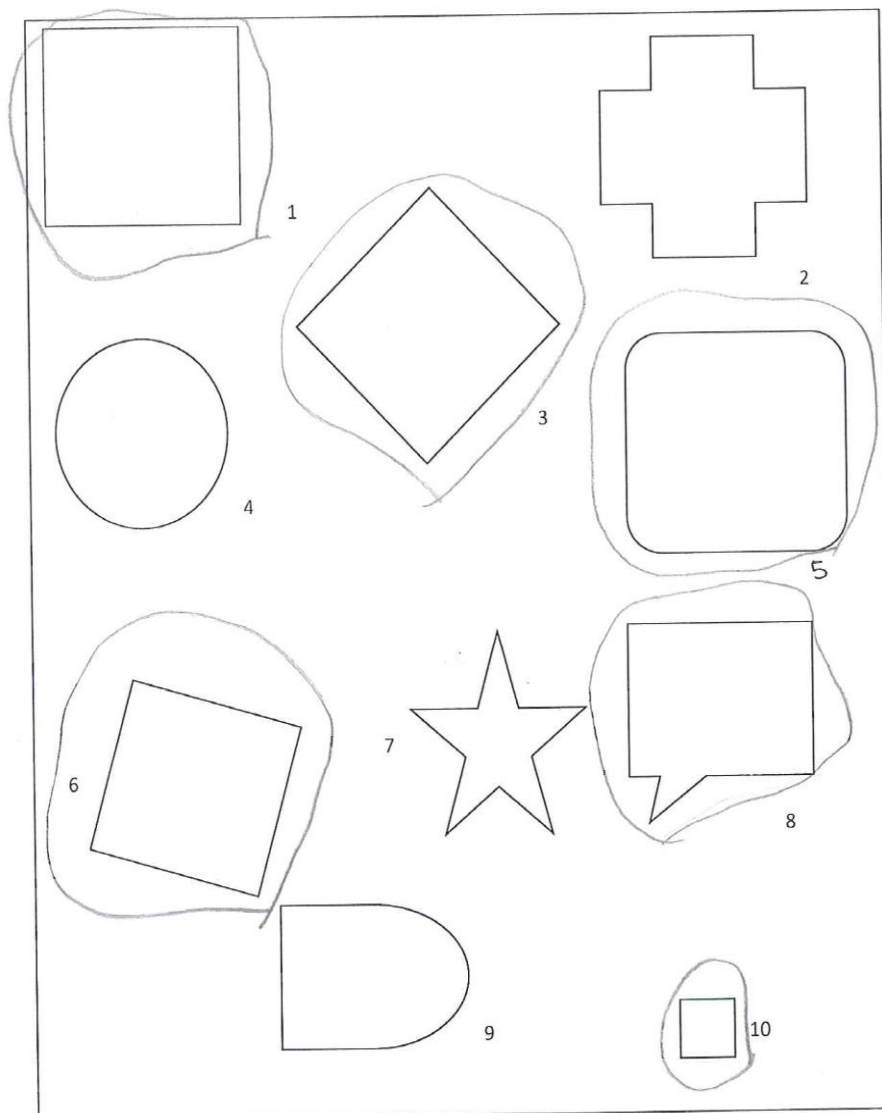

- ENCERCLA ELS RECTANGLES

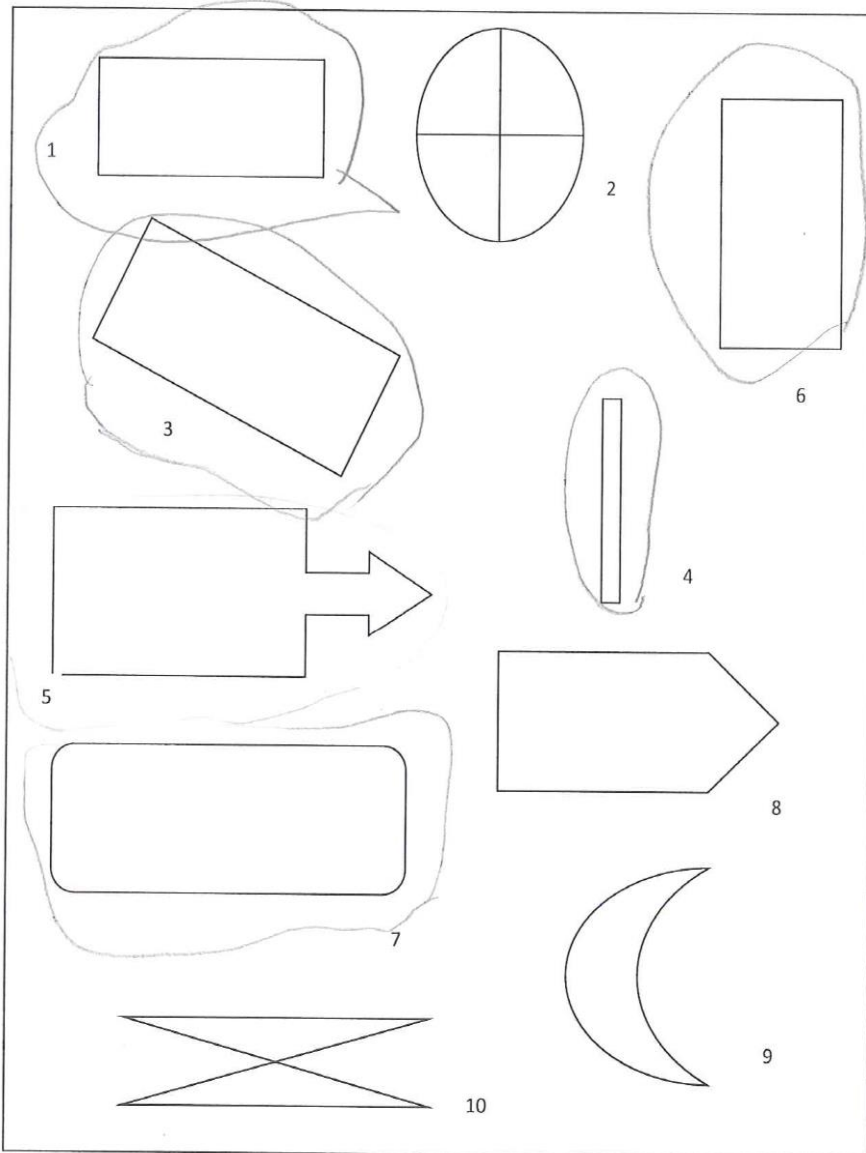

• ENCERCLA ELS TRIANGLES

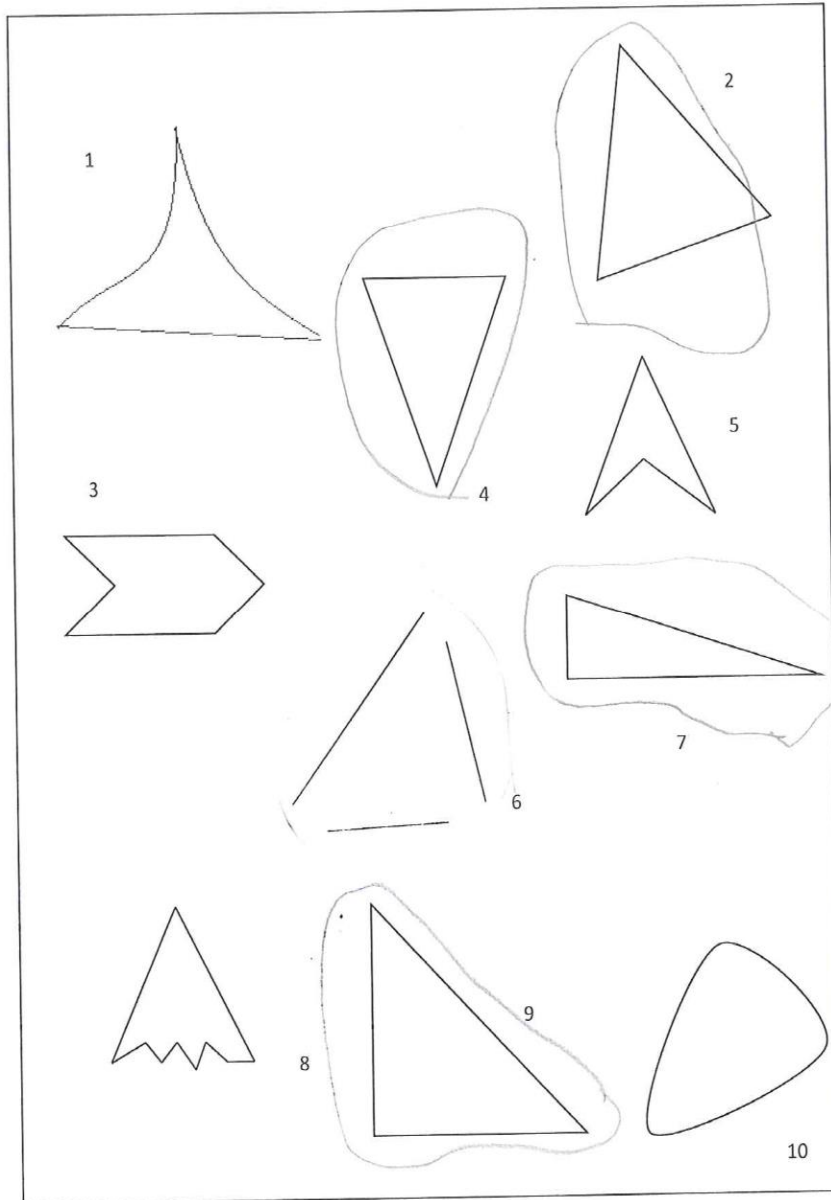



TEST PELS INFANTS DE P4B

1. DIBUIXA UN QUADRAT

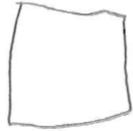

2. DIBUIXA UN RECTANGLE



3. DIBUIXA UN TRIANGLE



4. DIBUIXA UN CERCLE



5. QUANTS COSTATS TENEN AQUESTES FIGURES GEOMÈTRIQUES I VÈRTEXS

Costats      Vèrtexs



4

4

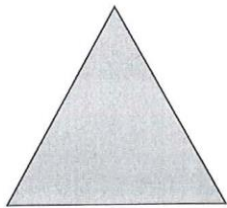

3

3



0

0



4

4

6. IDENTIFICA I ENCERCLA LES FIGURES GEOMÈTRIQUES.

- ENCERCLA ELS CERCLES

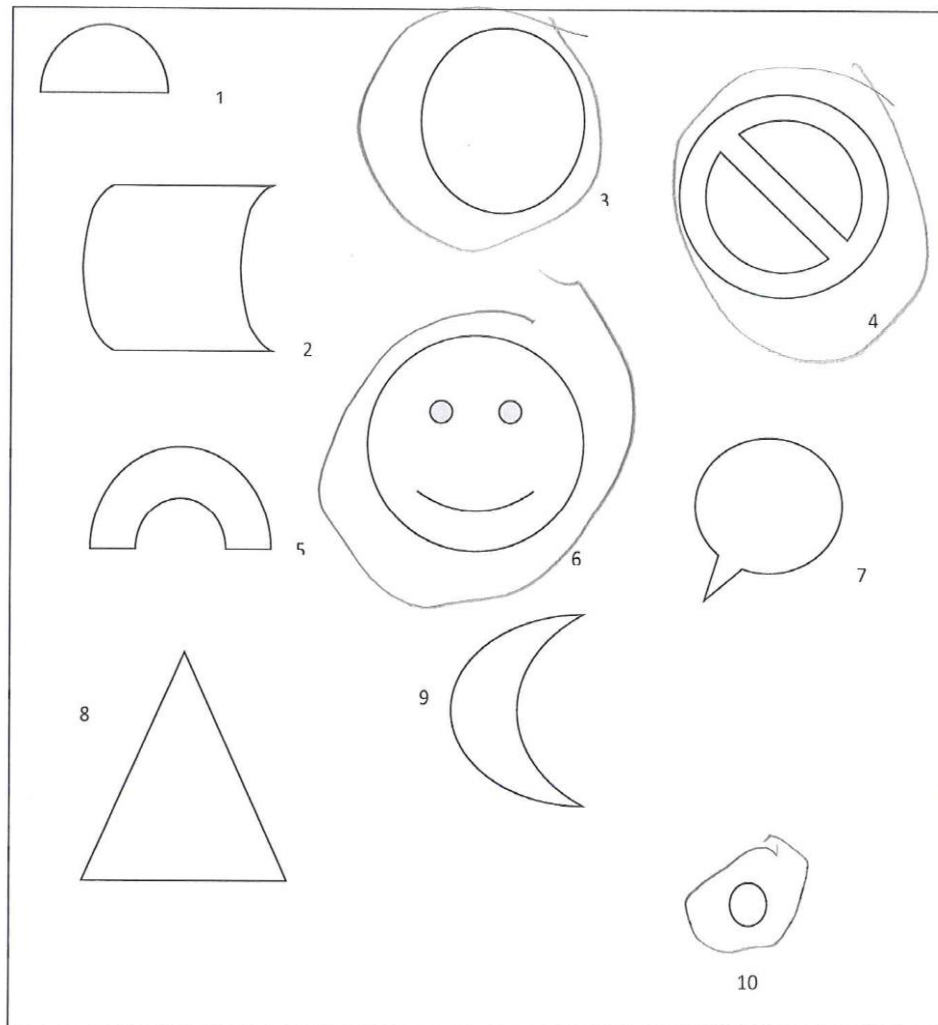

• ENCERCLA ELS QUADRATS

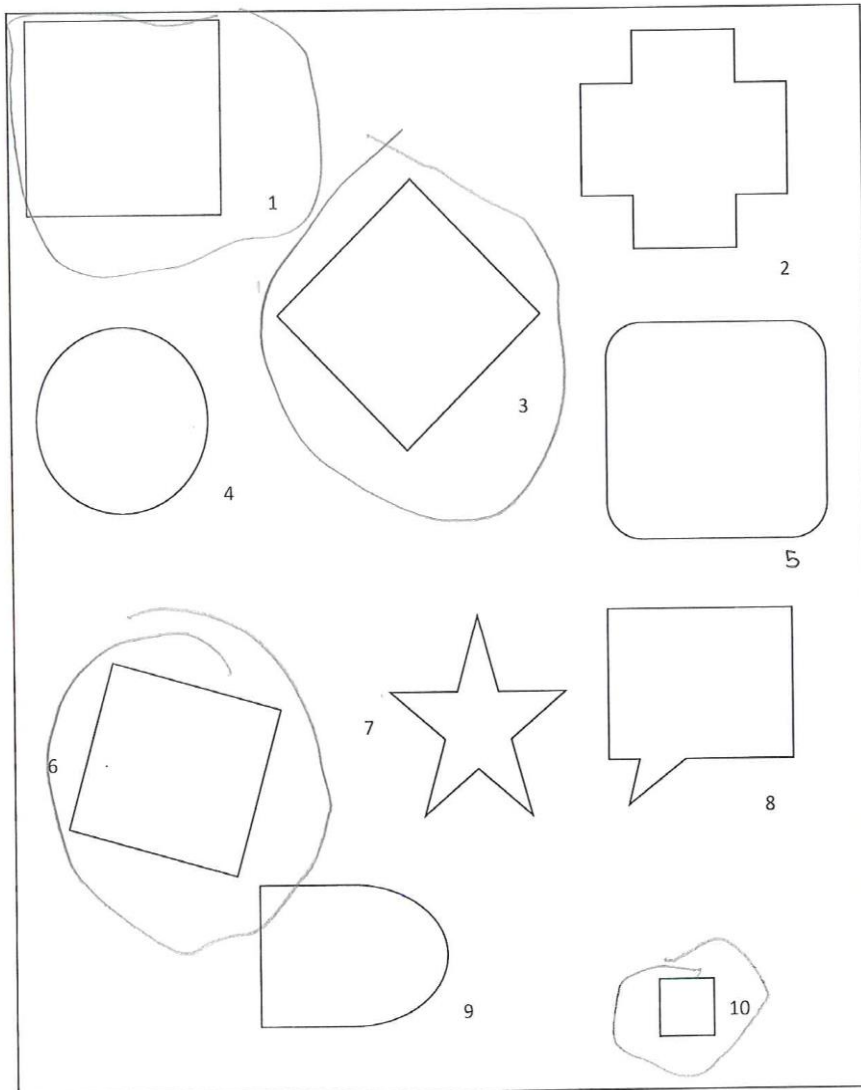

- ENCERCLA ELS RECTANGLES

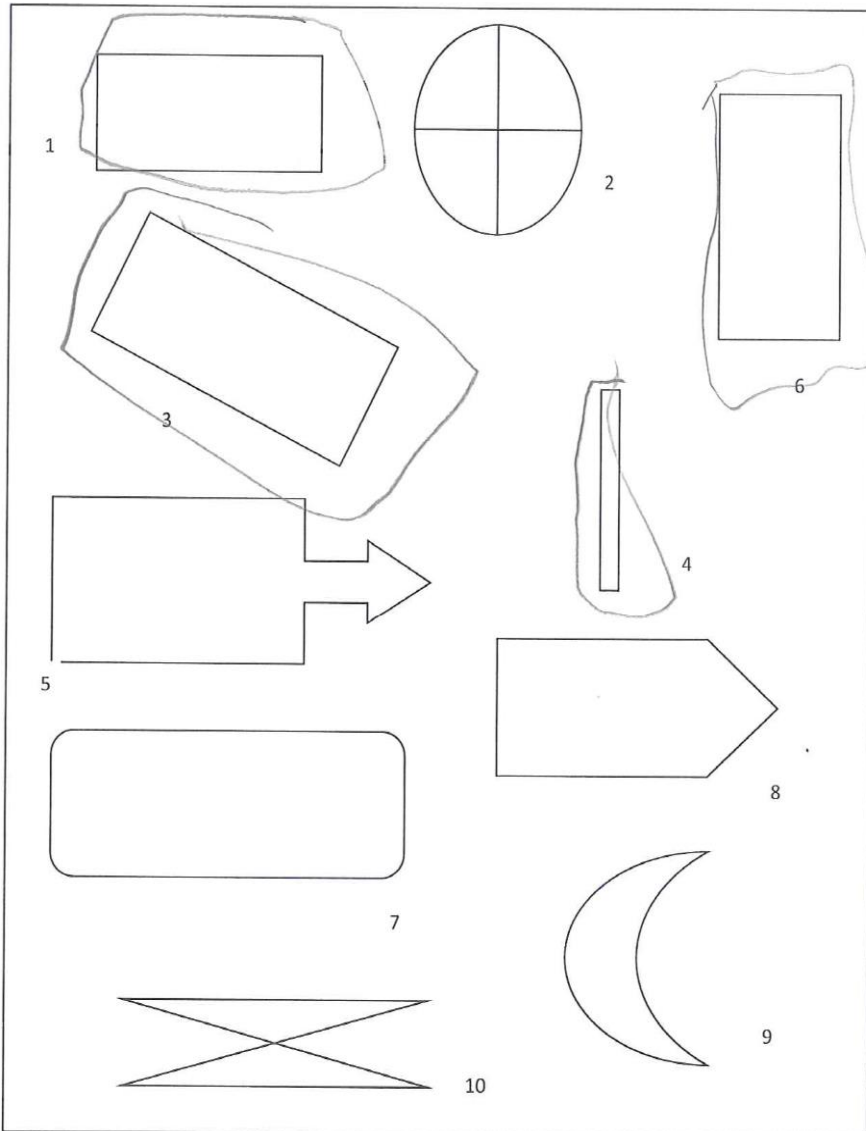

• ENCERCLA ELS TRIANGLES

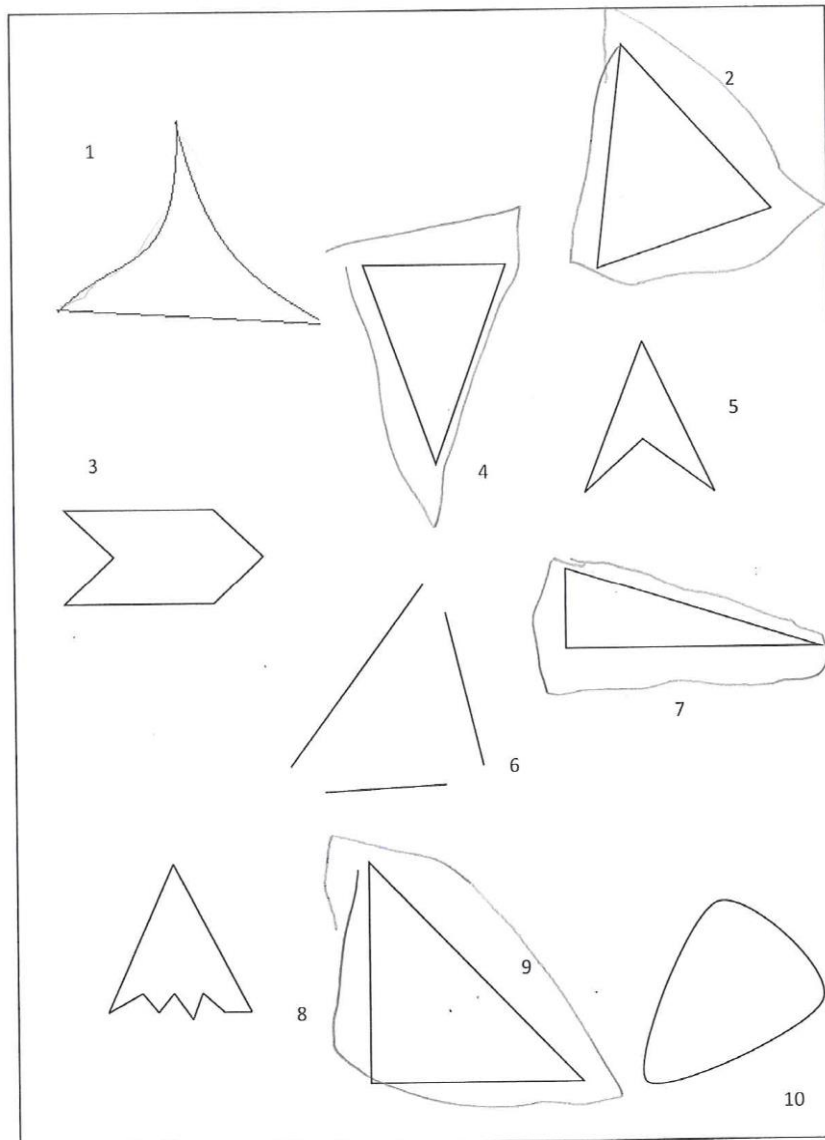

❌ No se puede mostrar la imagen en este momento.

 No se puede mostrar la imagen en este momento.



❌ No se puede mostrar la imagen en este momento.

❌ No se puede mostrar la imagen en este momento.

 No se puede mostrar la imagen en este momento.

 No se puede mostrar la imagen en este momento.

❌ No se puede mostrar la imagen en este momento.

❌ No se puede mostrar la imagen en este momento.







❌ No se puede mostrar la imagen en este momento.



❌ No se puede mostrar la imagen en este momento.

❌ No se puede mostrar la imagen en este momento.

 No se puede mostrar la imagen en este momento.





❌ No se puede mostrar la imagen en este momento.



❌ No se puede mostrar la imagen en este momento.

❌ No se puede mostrar la imagen en este momento.







❌ No se puede mostrar la imagen en este momento.

❌ No se puede mostrar la imagen en este momento.

❌ No se puede mostrar la imagen en este momento.



❌ No se puede mostrar la imagen en este momento.

❌ No se puede mostrar la imagen en este momento.

❌ No se puede mostrar la imagen en este momento.



❌ No se puede mostrar la imagen en este momento.



❌ No se puede mostrar la imagen en este momento.







