

TEST PELS INFANTS DE P4B

1. DIBUIXA UN QUADRAT

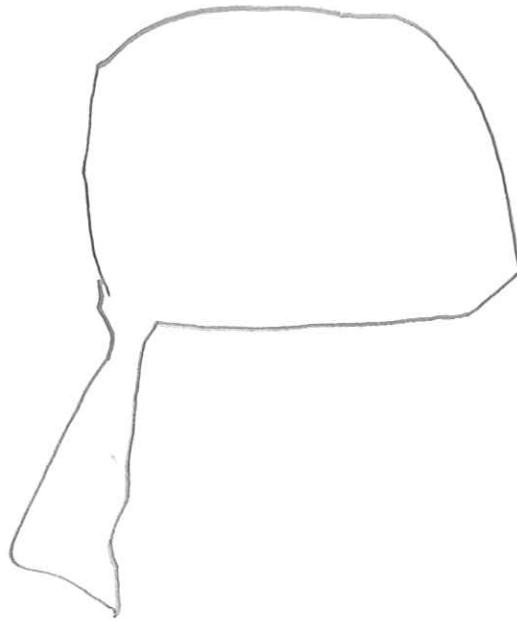

2. DIBUIXA UN RECTANGLE



3. DIBUIXA UN TRIANGLE

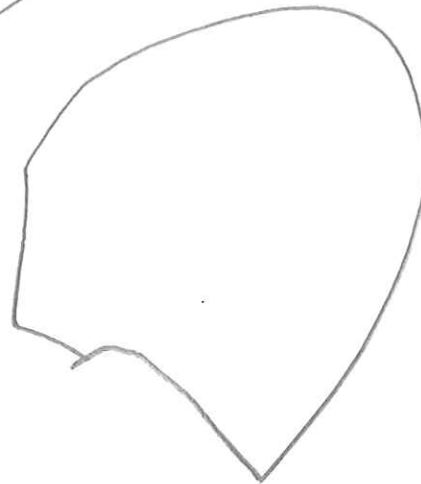

4. DIBUIXA UN CERCLE



5. QUANTS COSTATS TENEN AQUESTES FIGURES GEOMÈTRIQUES I VÈRTEXS

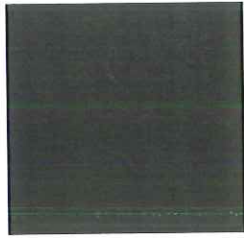

costats

Vertexs (Puntes)

4

4

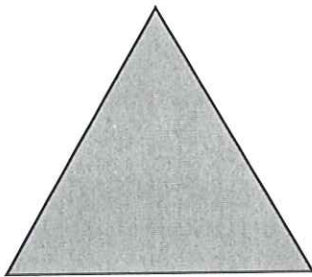

3

3



0

0



4

4

6. IDENTIFICA I ENCERCLA LES FIGURES GEOMÈTRIQUES.

- ENCERCLA ELS CERCLES

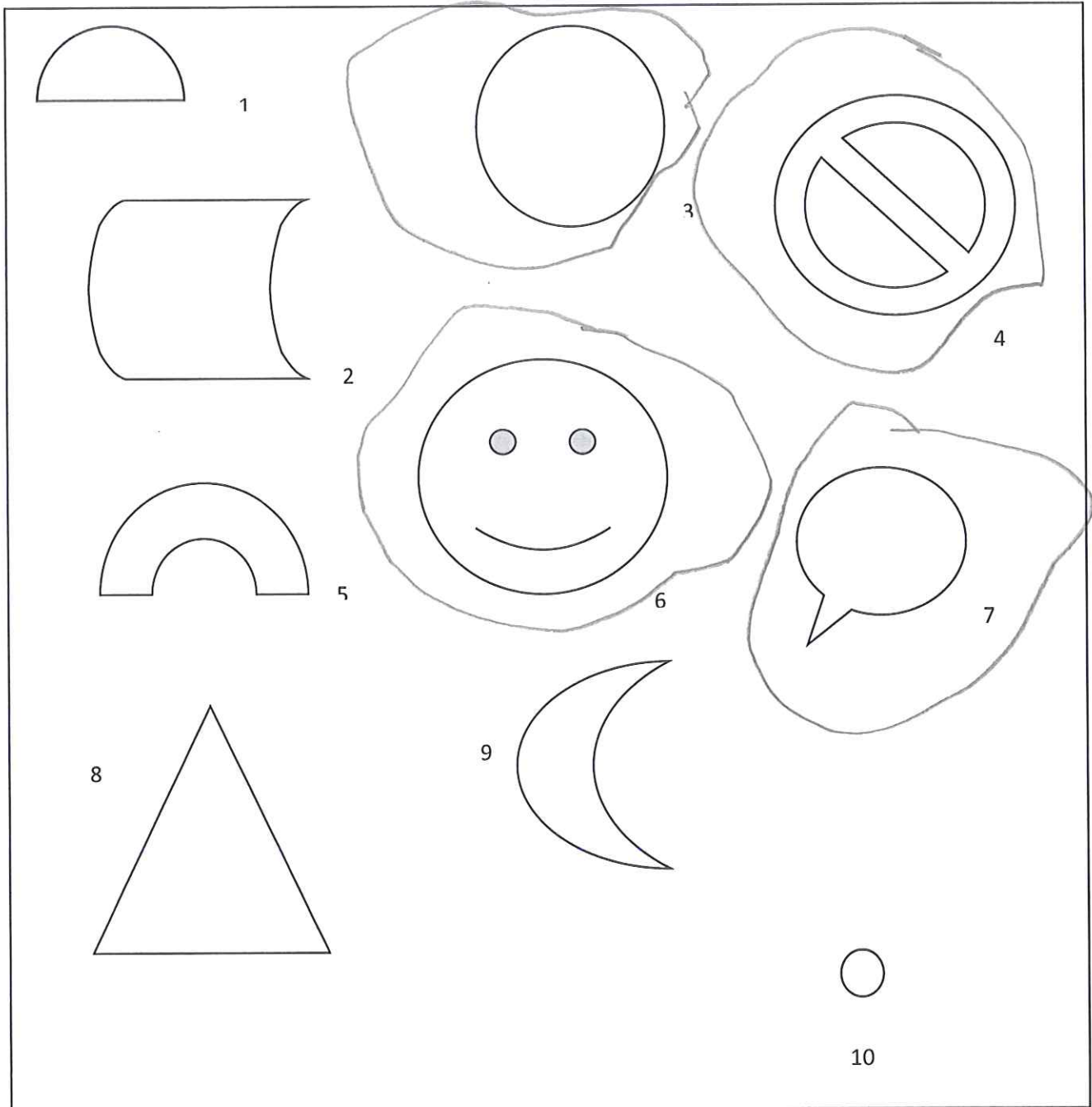

• ENCERCLA ELS QUADRATS

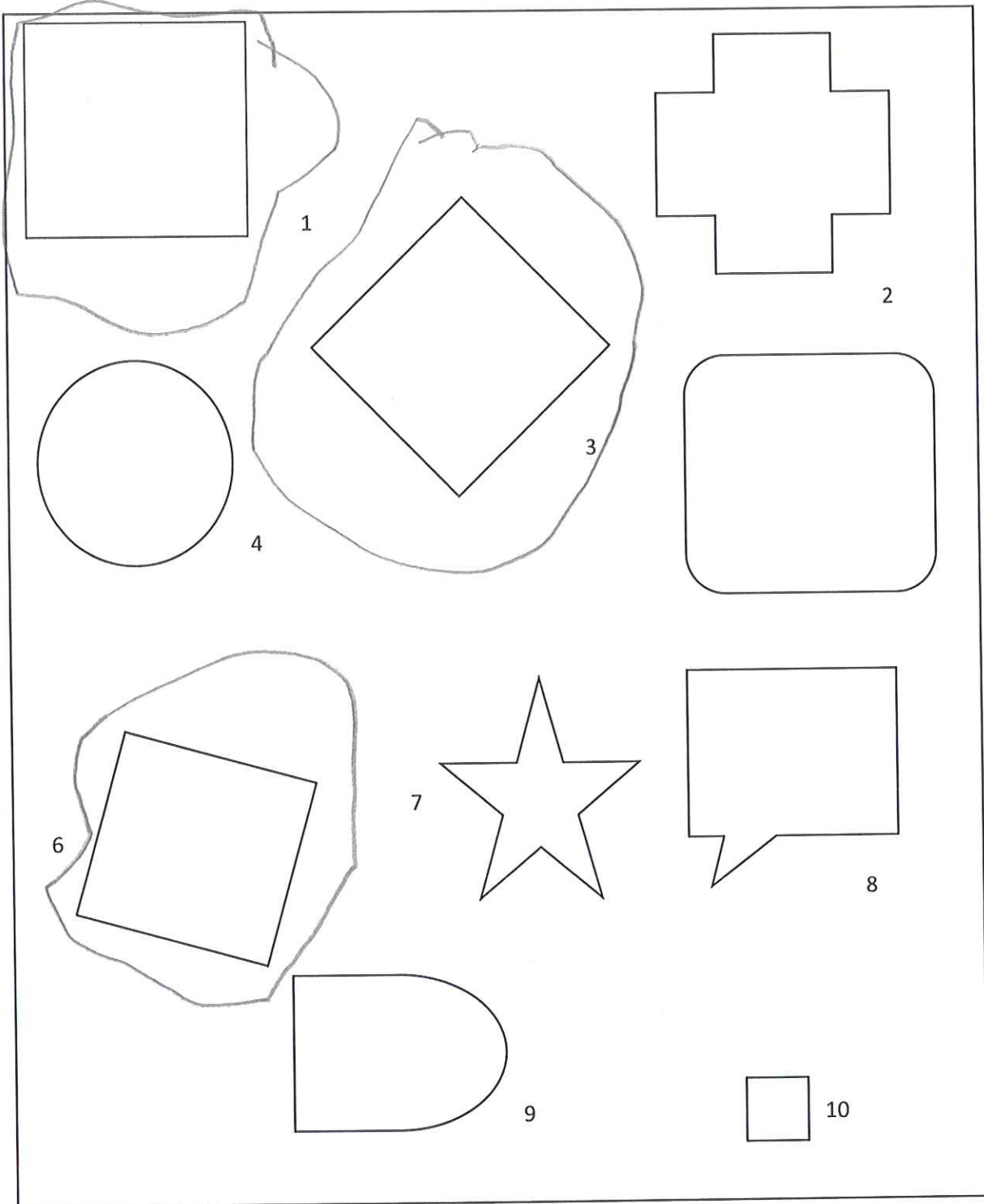

- ENCERCLA ELS RECTANGLES

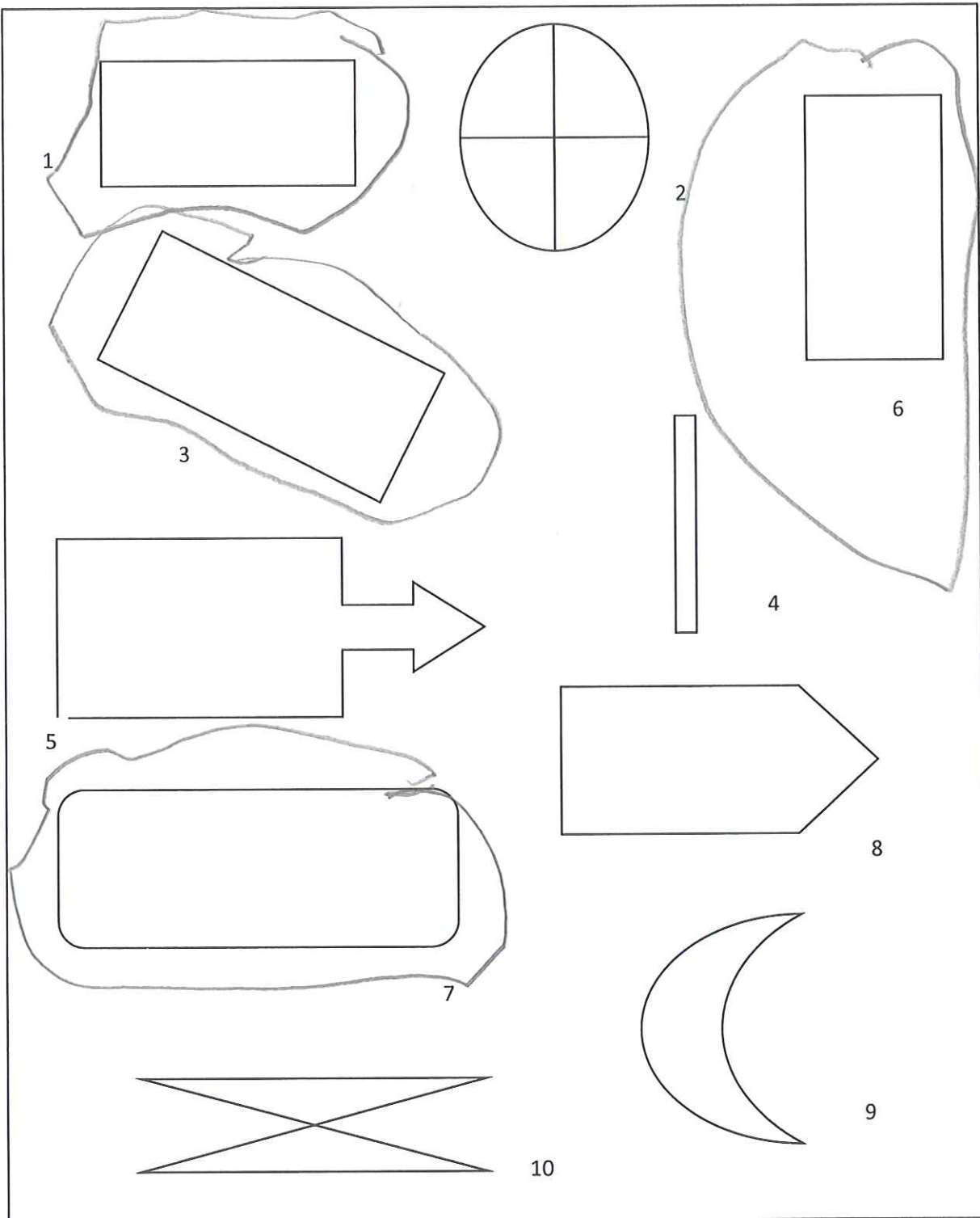

• ENCERCLA ELS TRIANGLES

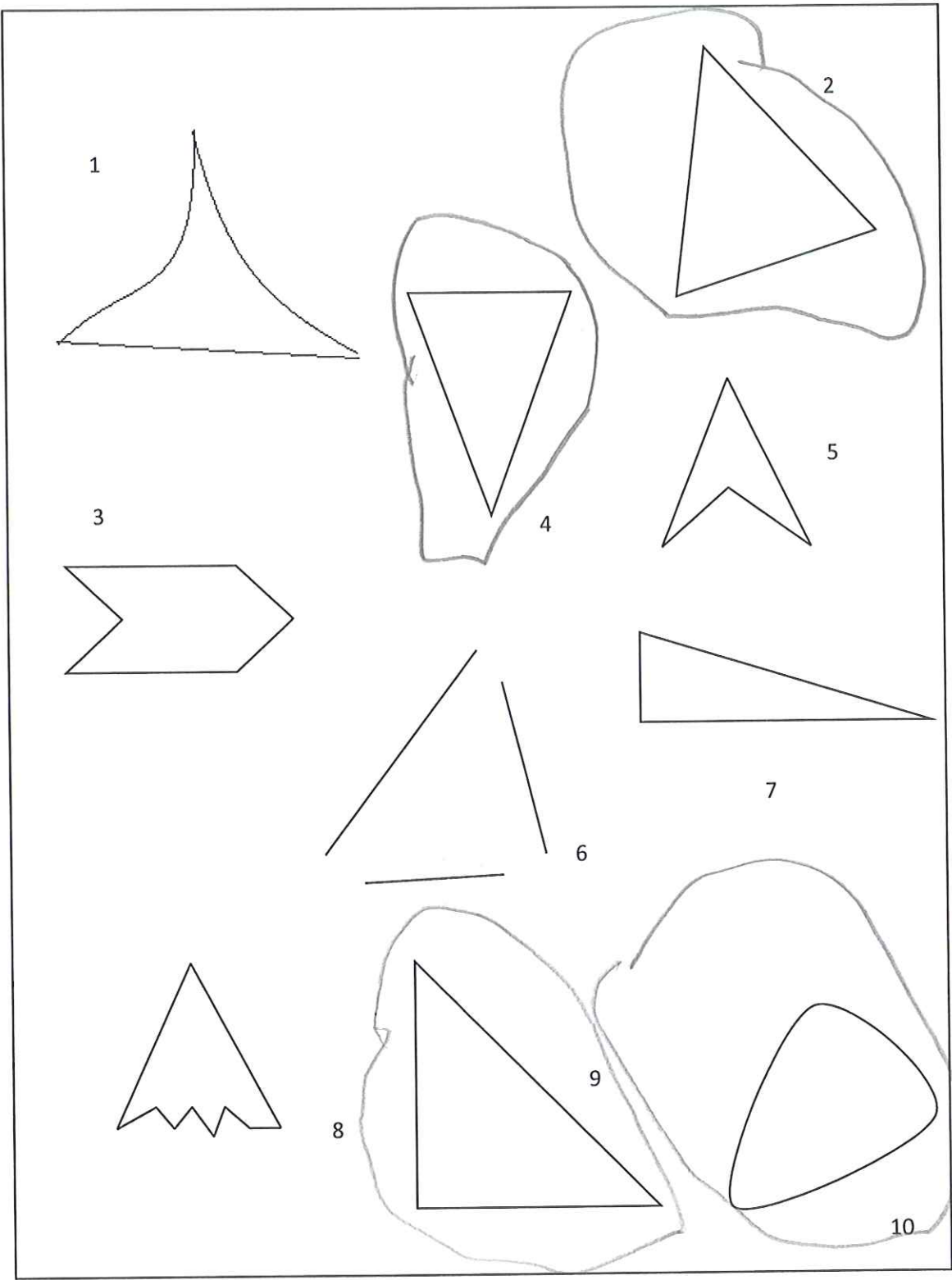

TEST PELS INFANTS DE P4B



1. DIBUIXA UN QUADRAT



2. DIBUIXA UN RECTANGLE

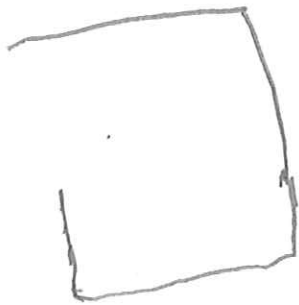

3. DIBUIXA UN TRIANGLE



4. DIBUIXA UN CERCLE



5. QUANTS COSTATS TENEN AQUESTES FIGURES GEOMÈTRIQUES I VÈRTEXS

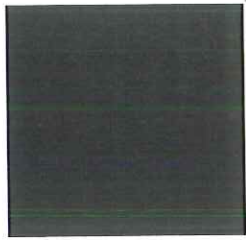

Costats

4

Vertebs (Punxes)

4

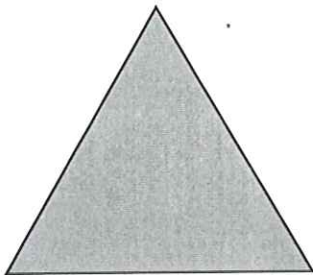

3

3



0

0



4

4

6. IDENTIFICA I ENCERCLA LES FIGURES GEOMÈTRIQUES.

- ENCERCLA ELS CERCLES

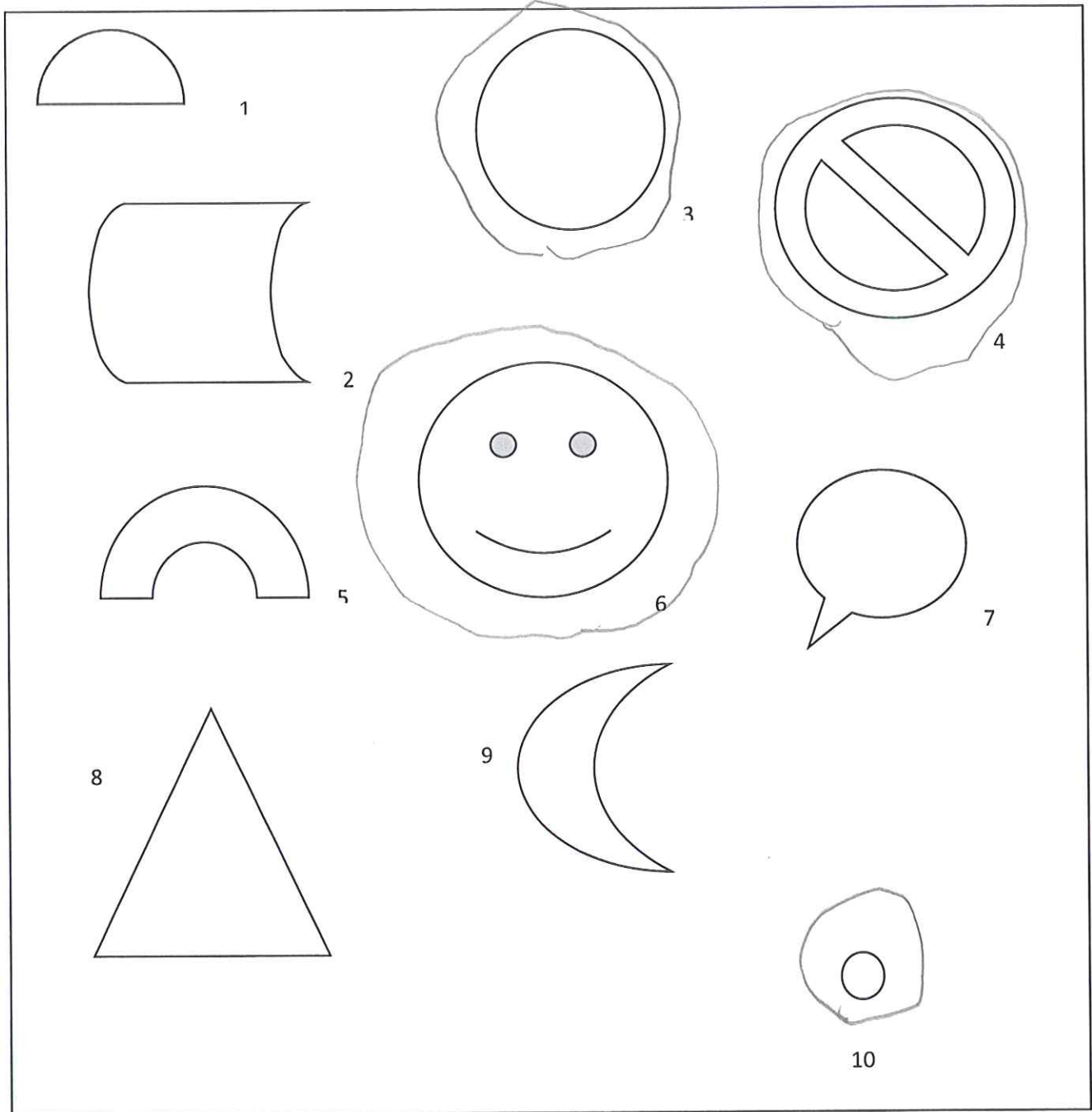

• ENCERCLA ELS QUADRATS

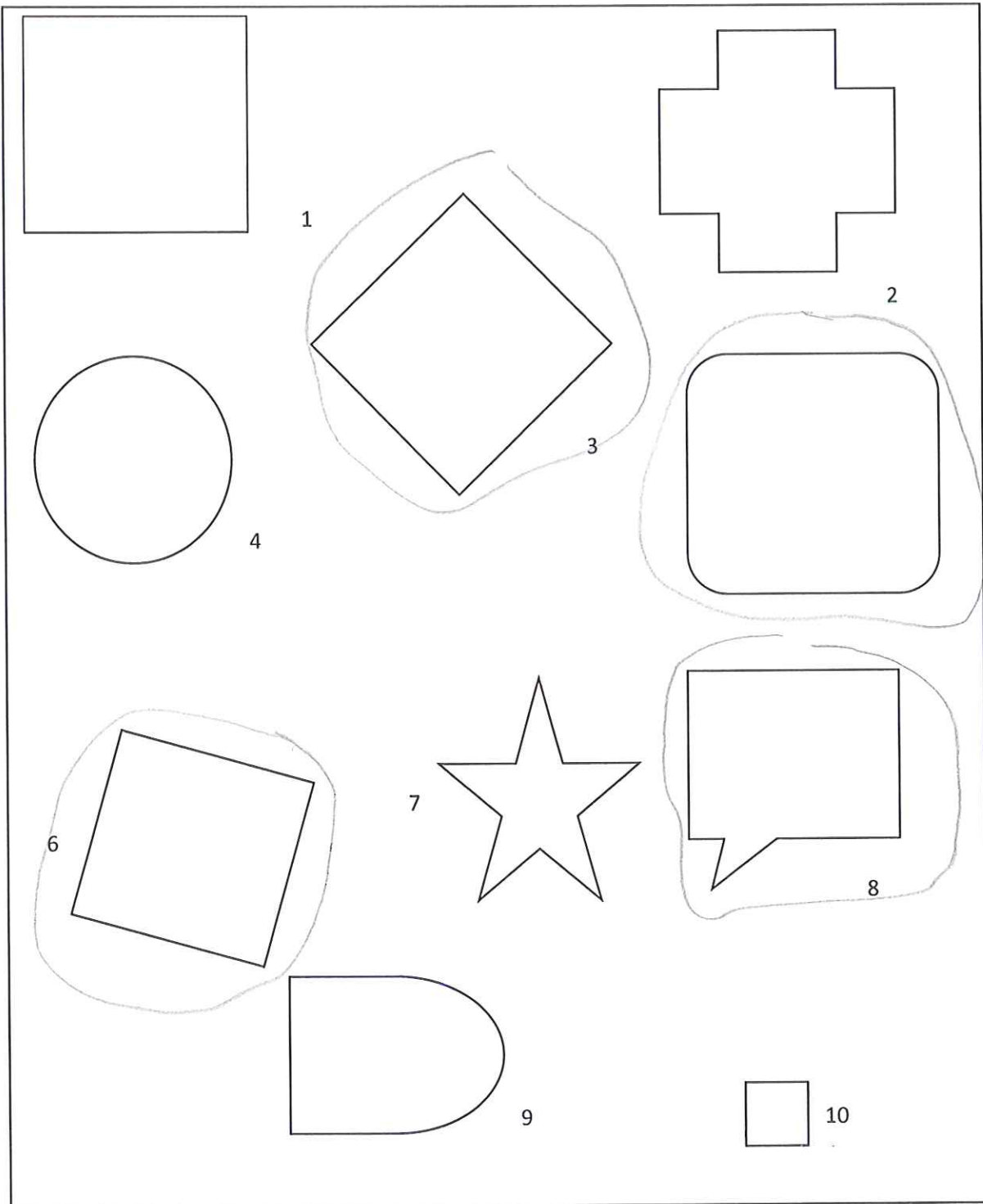

- ENCERCLA ELS RECTANGLES

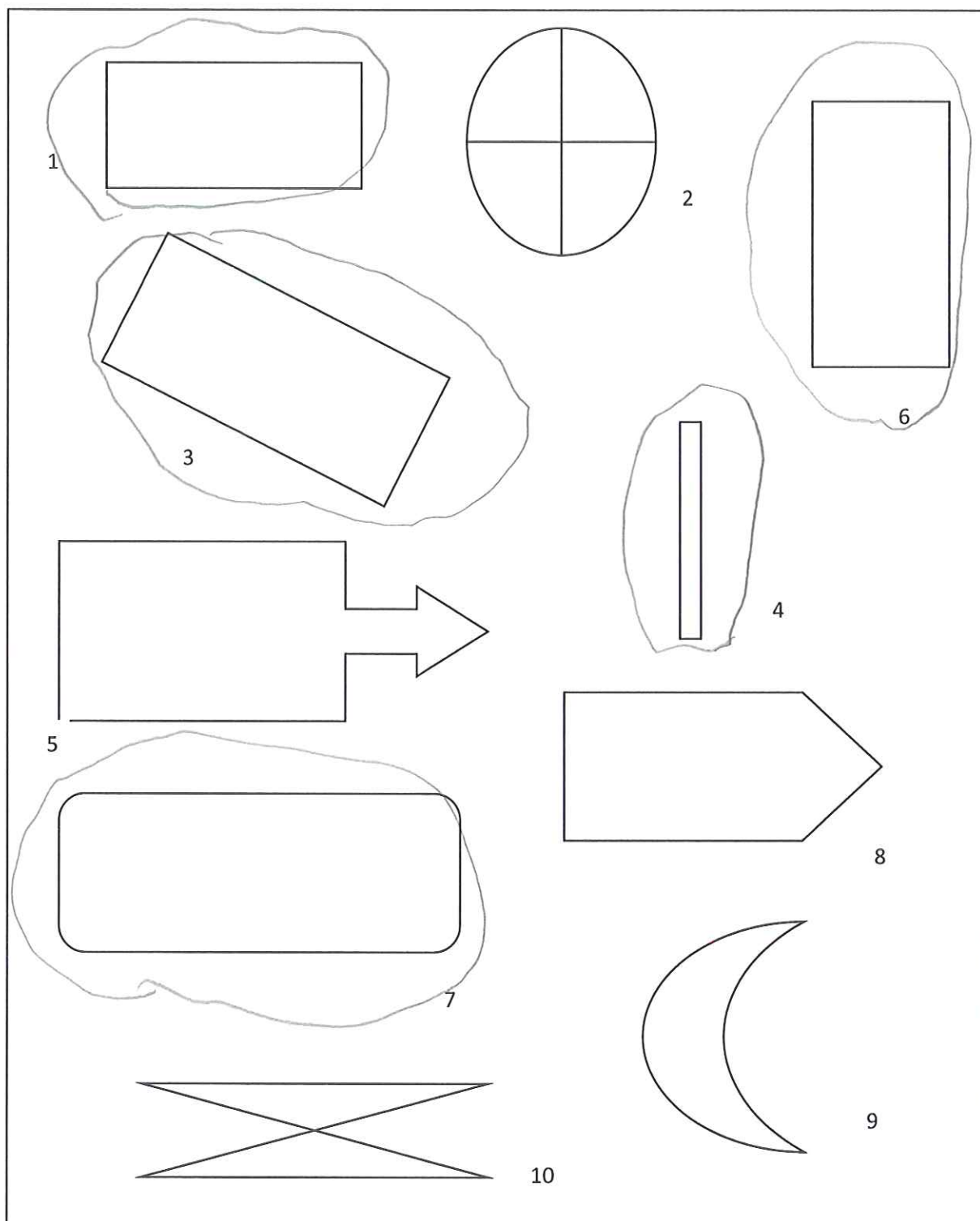

• ENCERCLA ELS TRIANGLES

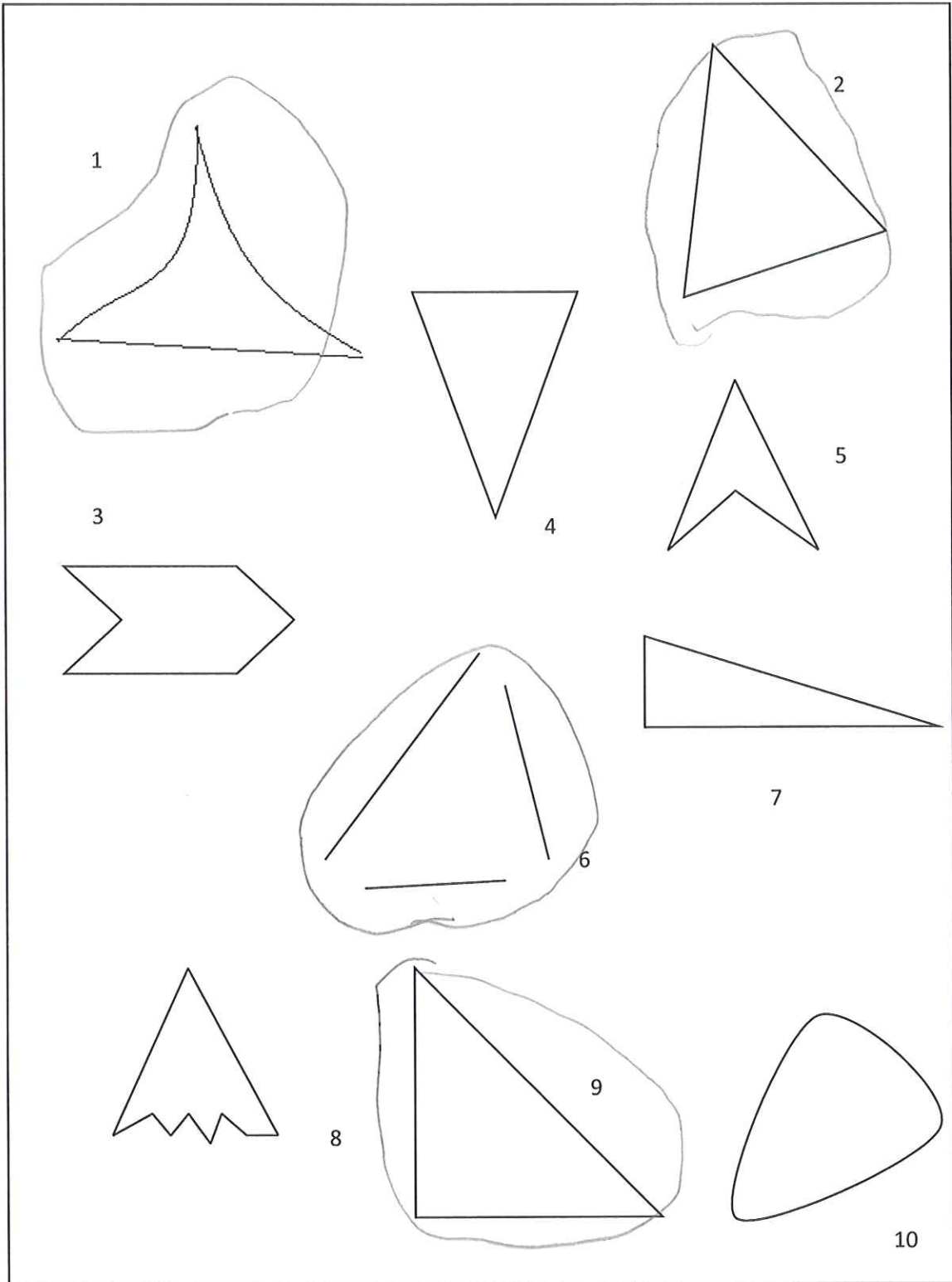

TEST PELS INFANTS DE P4B

1. DIBUIXA UN QUADRAT



2. DIBUIXA UN RECTANGLE



3. DIBUIXA UN TRIANGLE



4. DIBUIXA UN CERCLE



5. QUANTS COSTATS TENEN AQUESTES FIGURES GEOMÈTRIQUES I VÈRTEXS

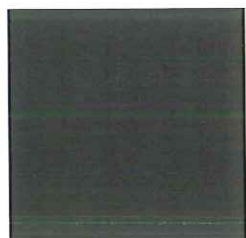

costats

vertexs

1

4

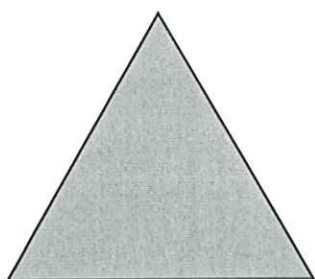

2

3



1

0



2

4

6. IDENTIFICA I ENCERCLA LES FIGURES GEOMÈTRIQUES.

- ENCERCLA ELS CERCLES

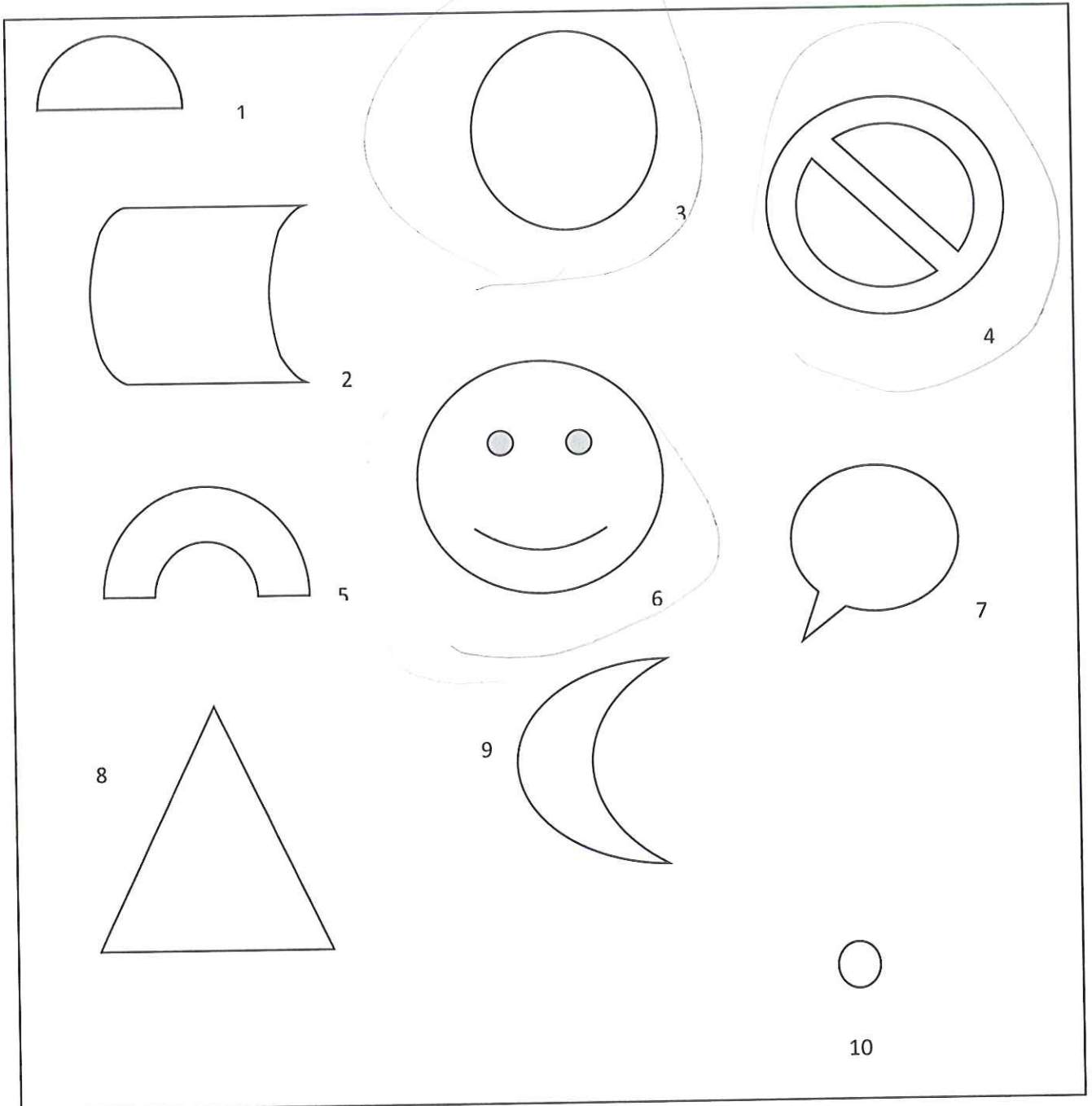

• ENCERCLA ELS QUADRATS

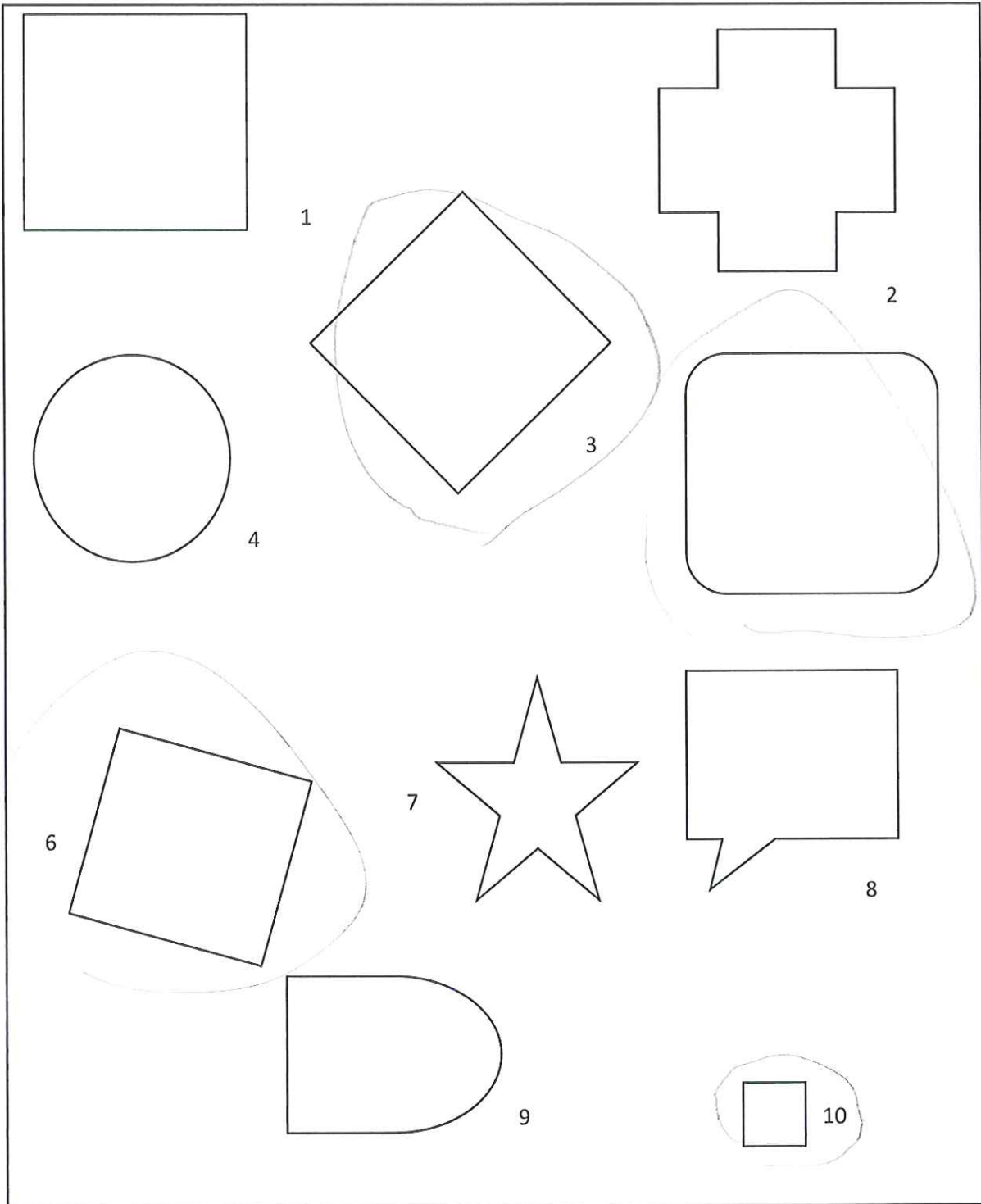

- ENCERCLA ELS RECTANGLES

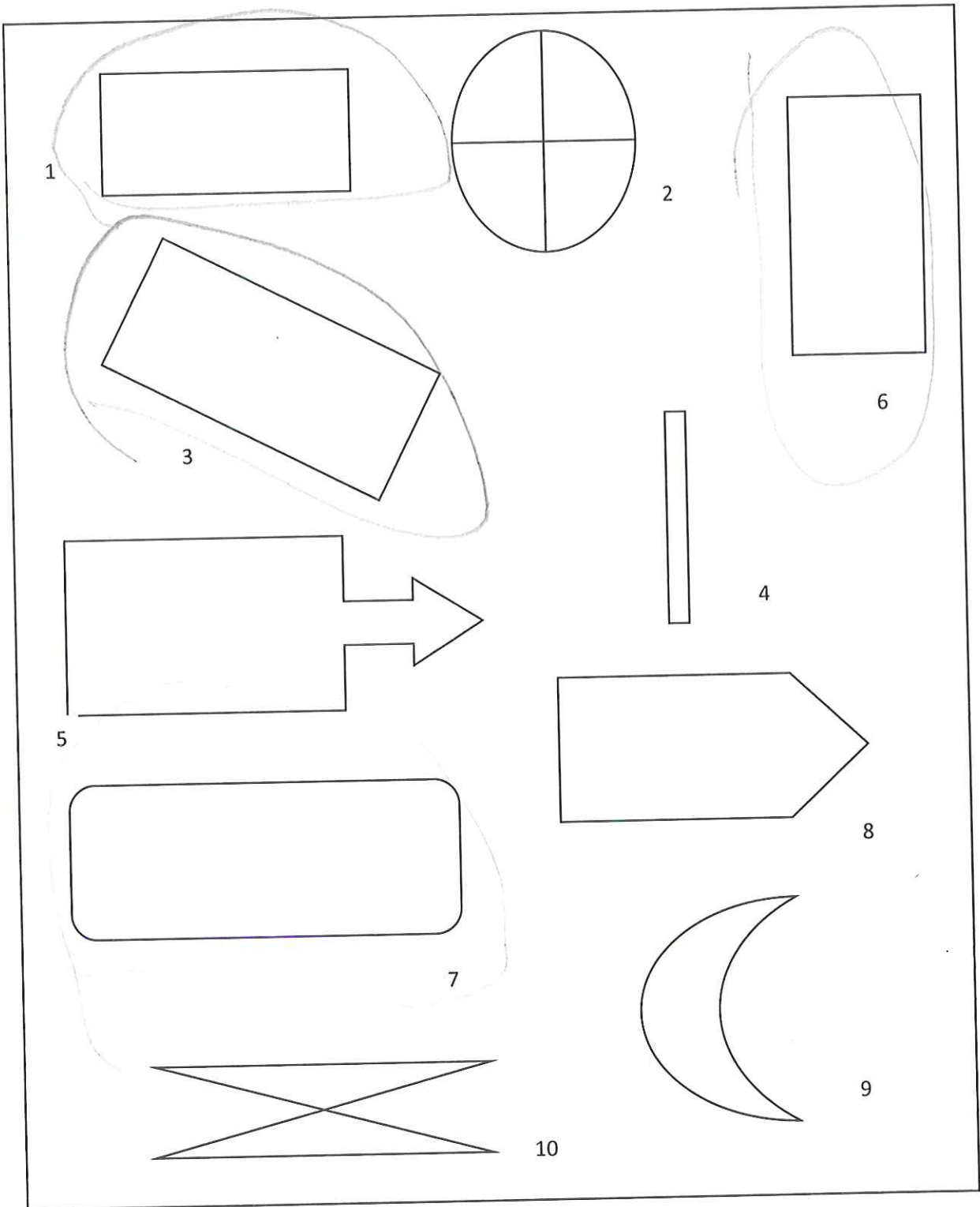

• ENCERCLA ELS TRIANGLES

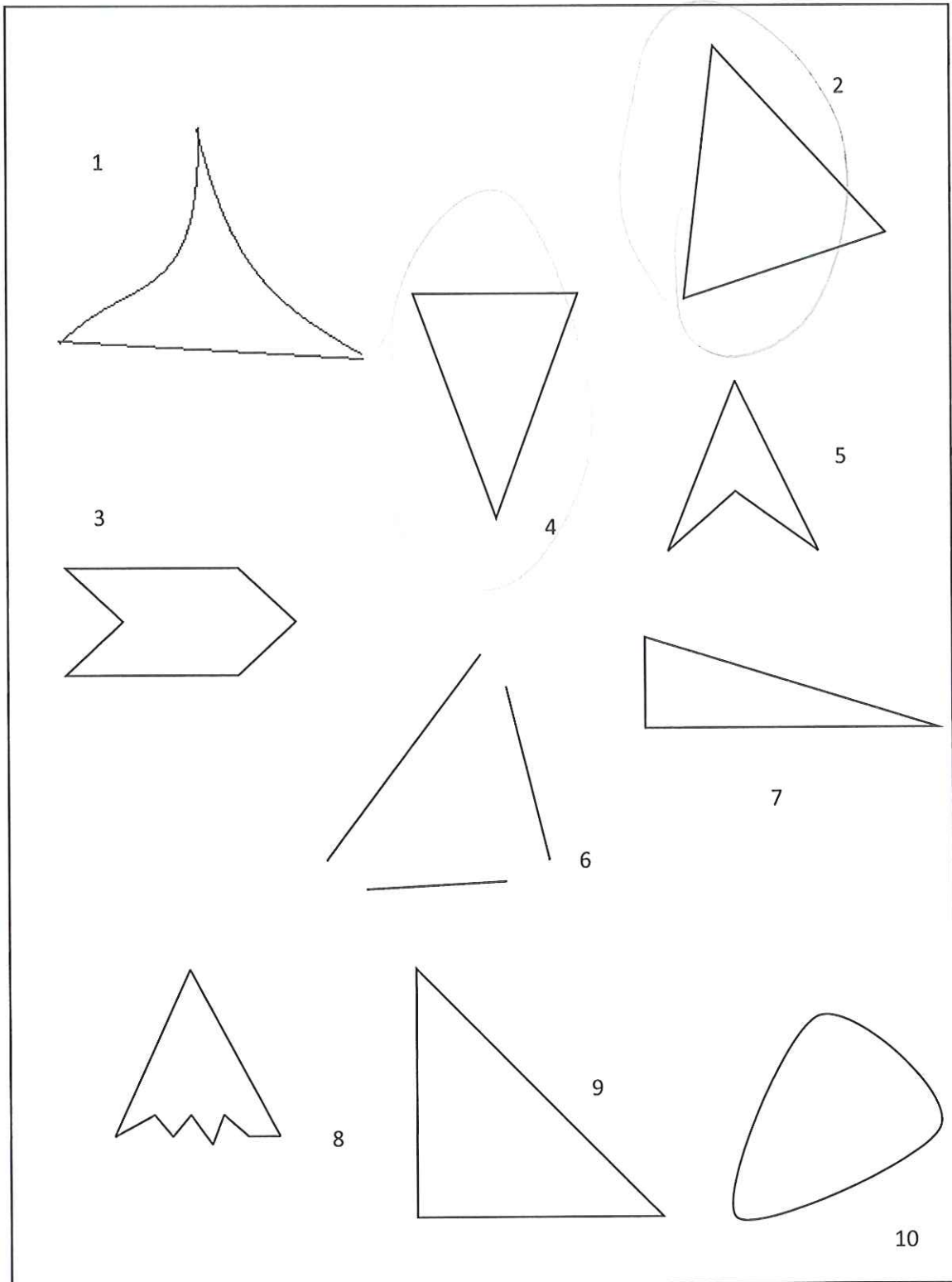

TEST PELS INFANTS DE P4B

1. DIBUIXA UN QUADRAT



2. DIBUIXA UN RECTANGLE

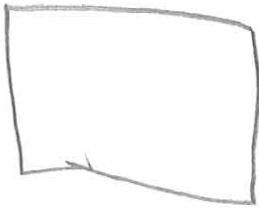

3. DIBUIXA UN TRIANGLE

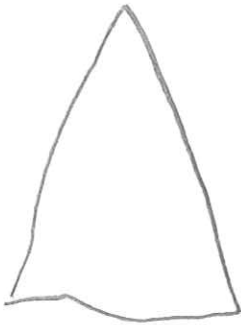

4. DIBUIXA UN CERCLE



5. QUANTS COSTATS TENEN AQUESTES FIGURES GEOMÈTRIQUES I VÈRTEXS



Costats

4

Vertexs

4

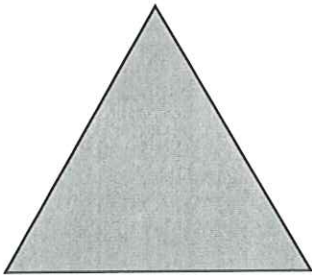

3

3



4



4

4

6. IDENTIFICA I ENCERCLA LES FIGURES GEOMÈTRIQUES.

- ENCERCLA ELS CERCLES

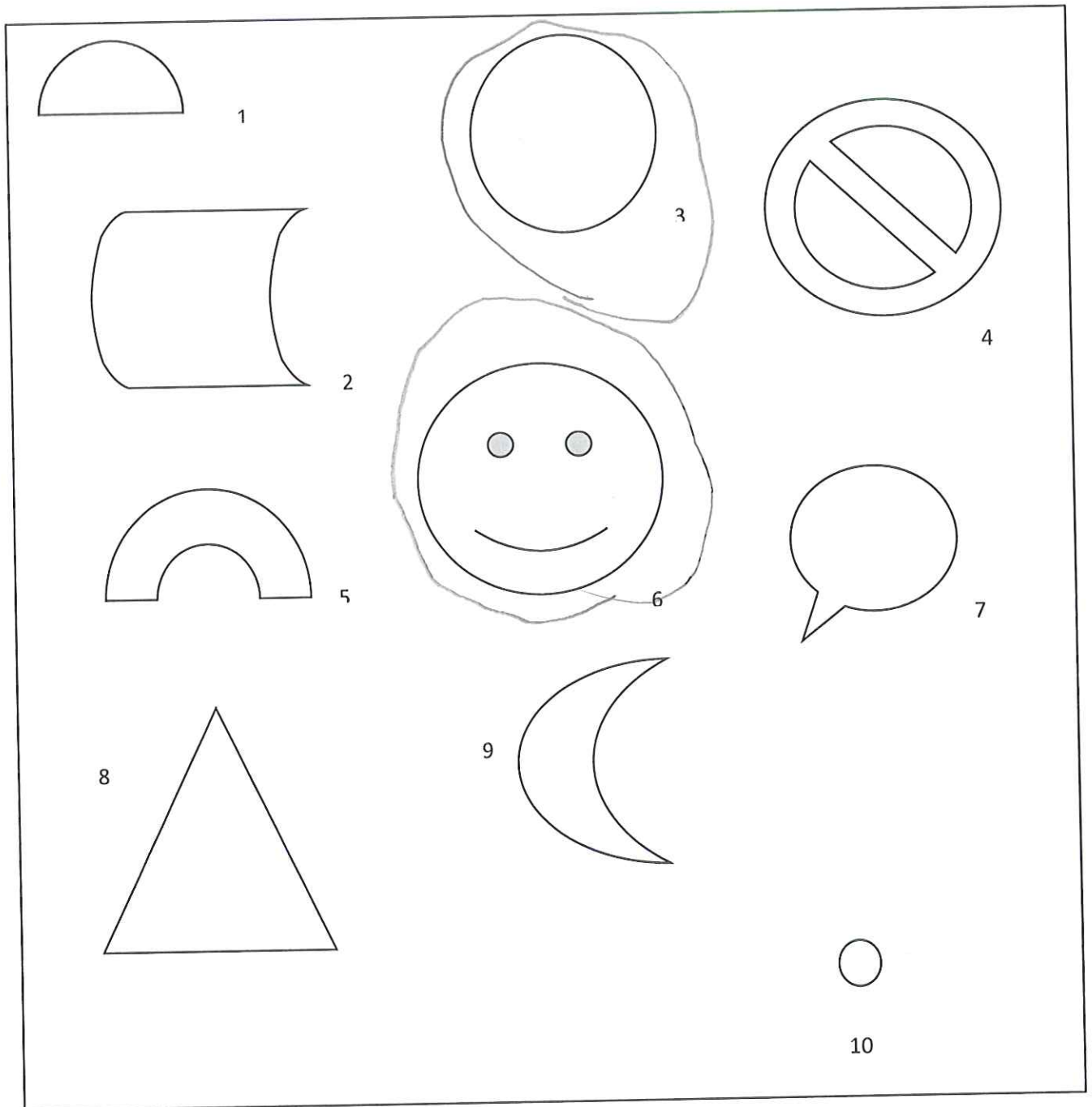

• ENCERCLA ELS QUADRATS

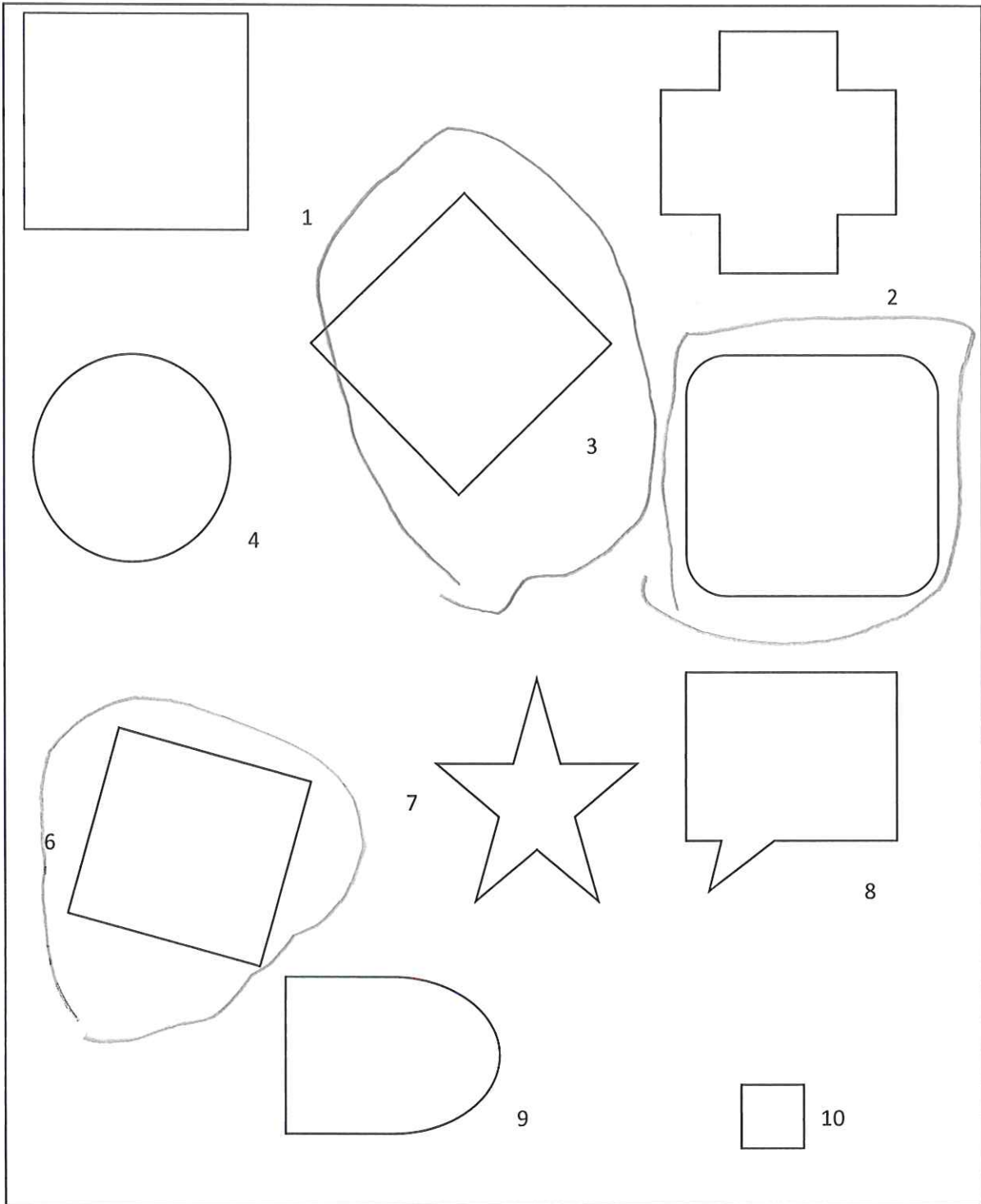

- ENCERCLA ELS RECTANGLES

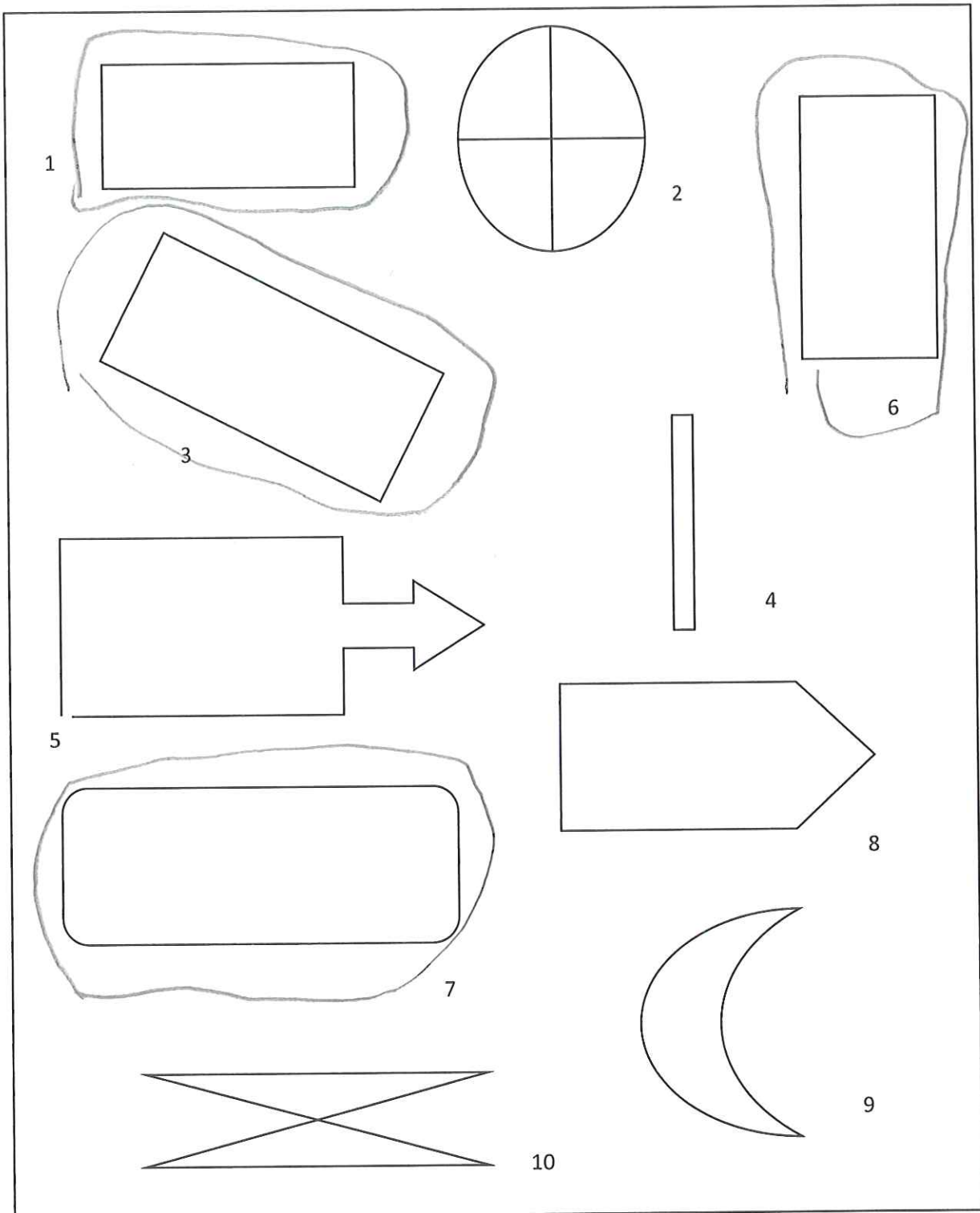

• ENCERCLA ELS TRIANGLES

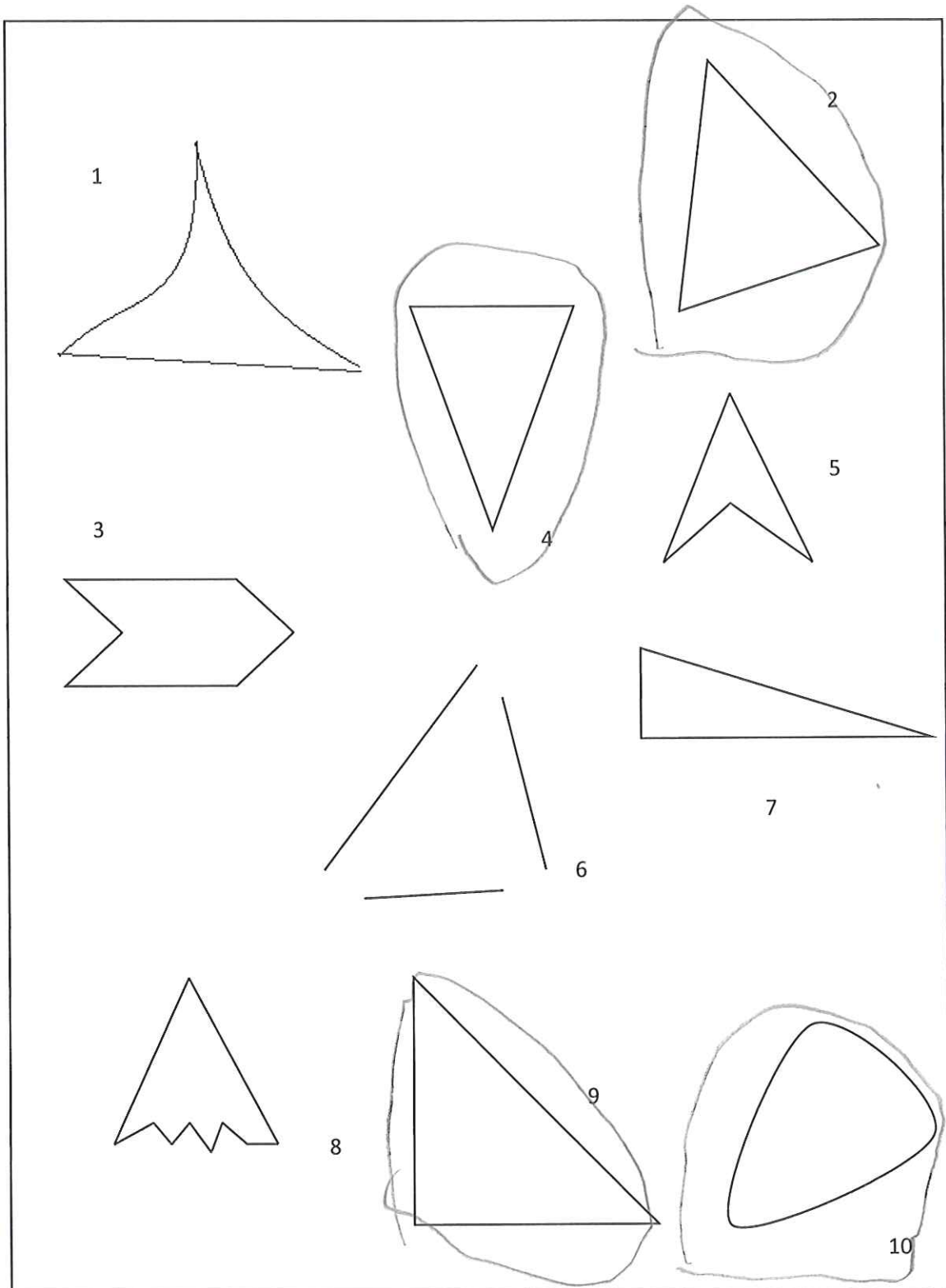

TEST PELS INFANTS DE P4B

1. DIBUIXA UN QUADRAT



2. DIBUIXA UN RECTANGLE



3. DIBUIXA UN TRIANGLE



4. DIBUIXA UN CERCLE



5. QUANTS COSTATS TENEN AQUESTES FIGURES GEOMÈTRIQUES I VÈRTEXS

costats

Vertexs.



4

4

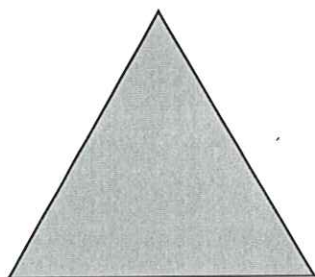

3

3



1

1.



4

4

6. IDENTIFICA I ENCERCLA LES FIGURES GEOMÈTRIQUES.

- ENCERCLA ELS CERCLES

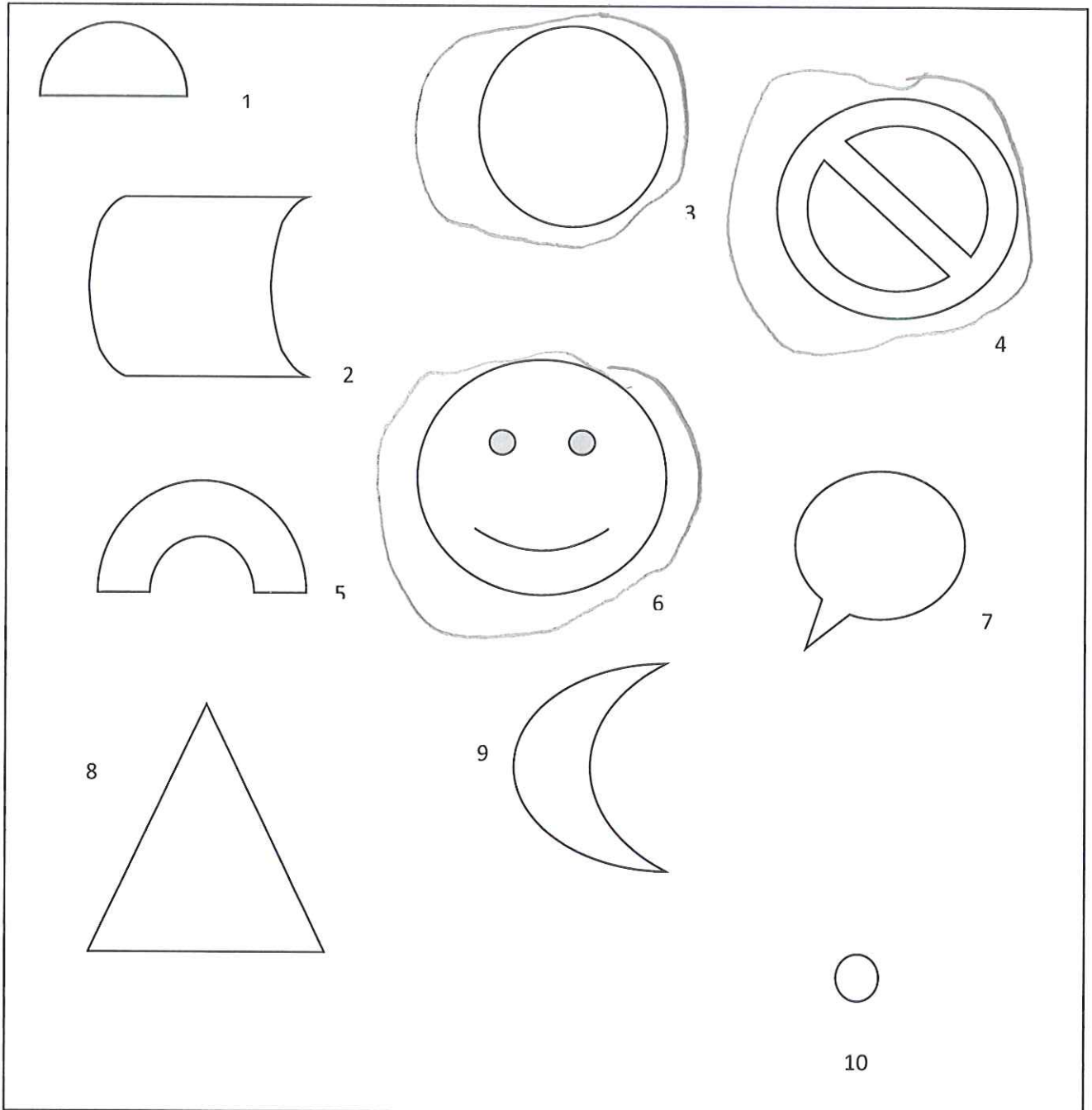

• ENCERCLA ELS QUADRATS

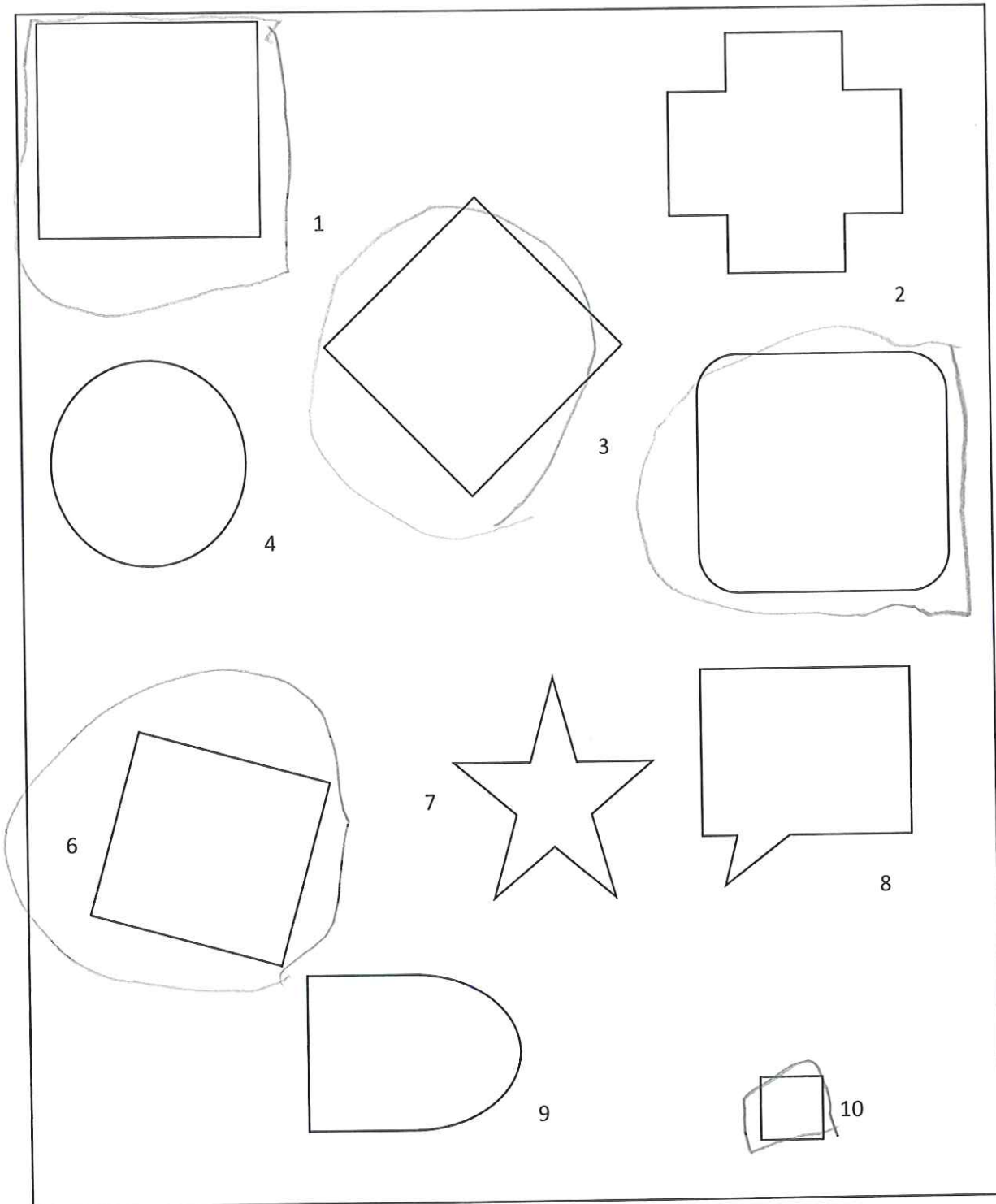

- ENCERCLA ELS RECTANGLES

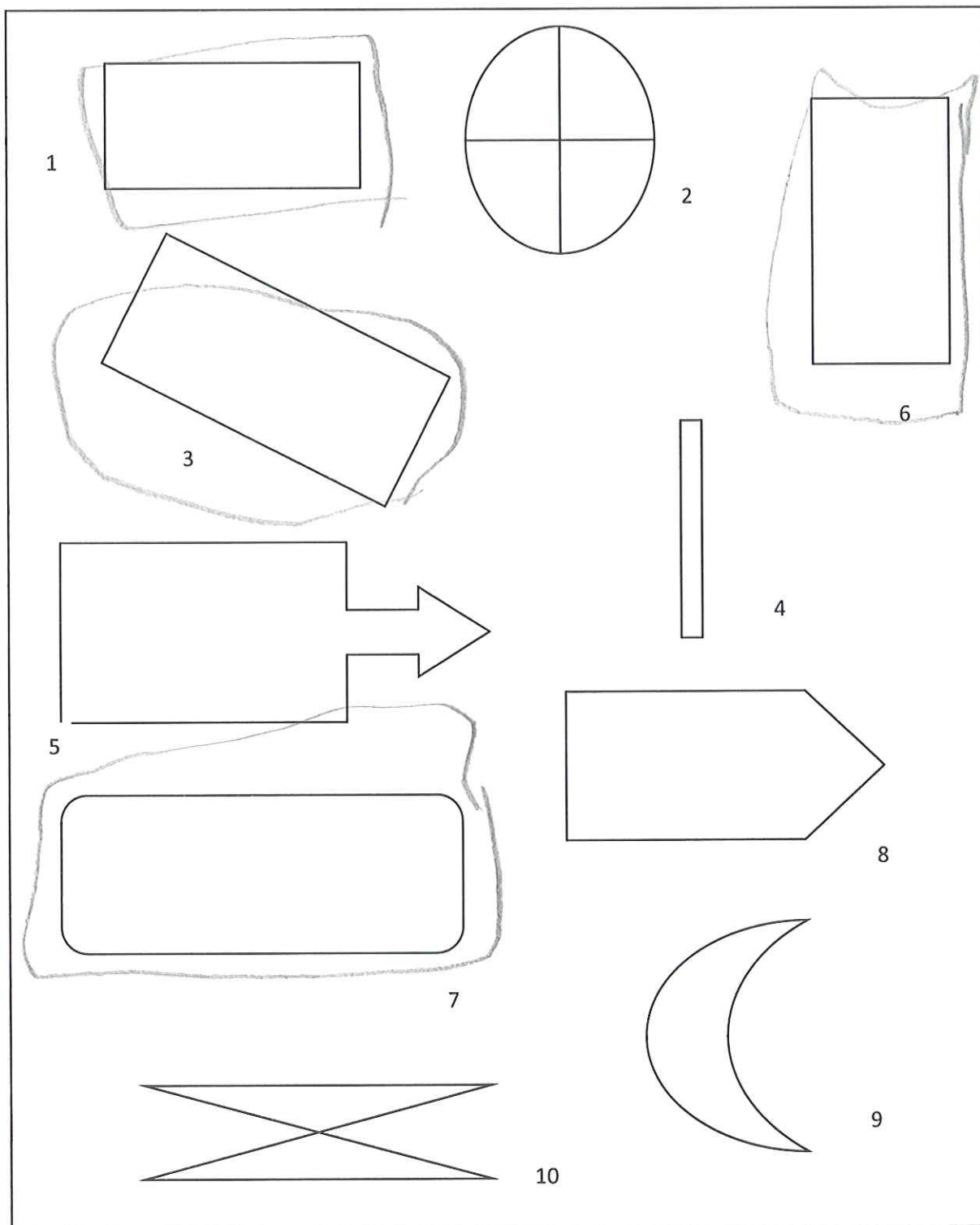

• ENCERCLA ELS TRIANGLES

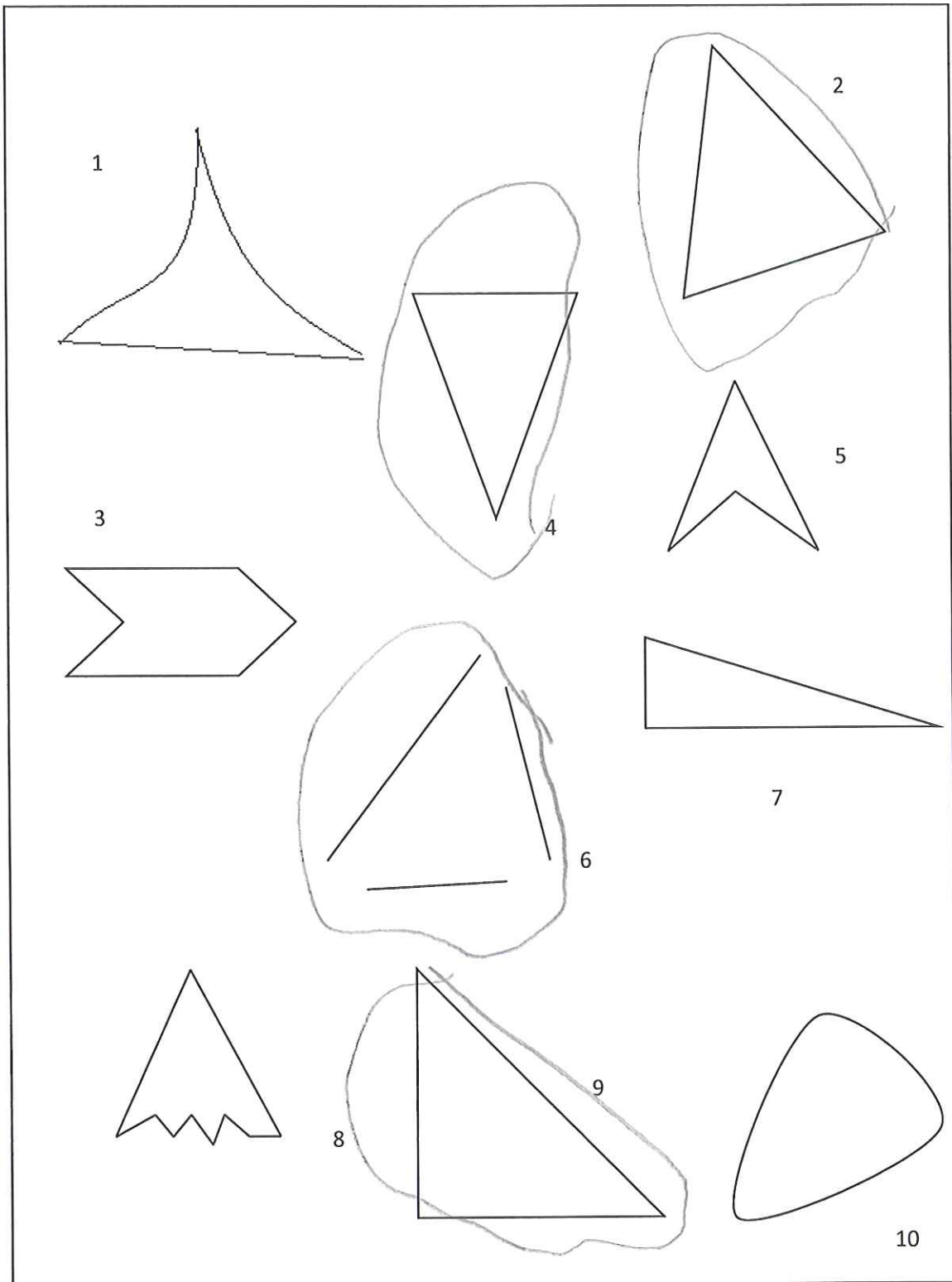

TEST PELS INFANTS DE P4B

1. DIBUIXA UN QUADRAT



2. DIBUIXA UN RECTANGLE



3. DIBUIXA UN TRIANGLE



4. DIBUIXA UN CERCLE



5. QUANTS COSTATS TENEN AQUESTES FIGURES GEOMÈTRIQUES I VÈRTEXS



Costats

4

Vèrtexs.

4

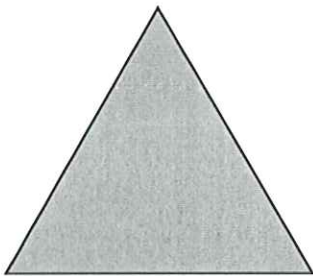

3

3



3

3

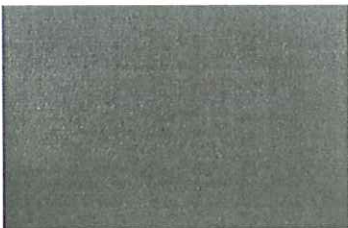

4

4

6. IDENTIFICA I ENCERCLA LES FIGURES GEOMÈTRIQUES.

- ENCERCLA ELS CERCLES

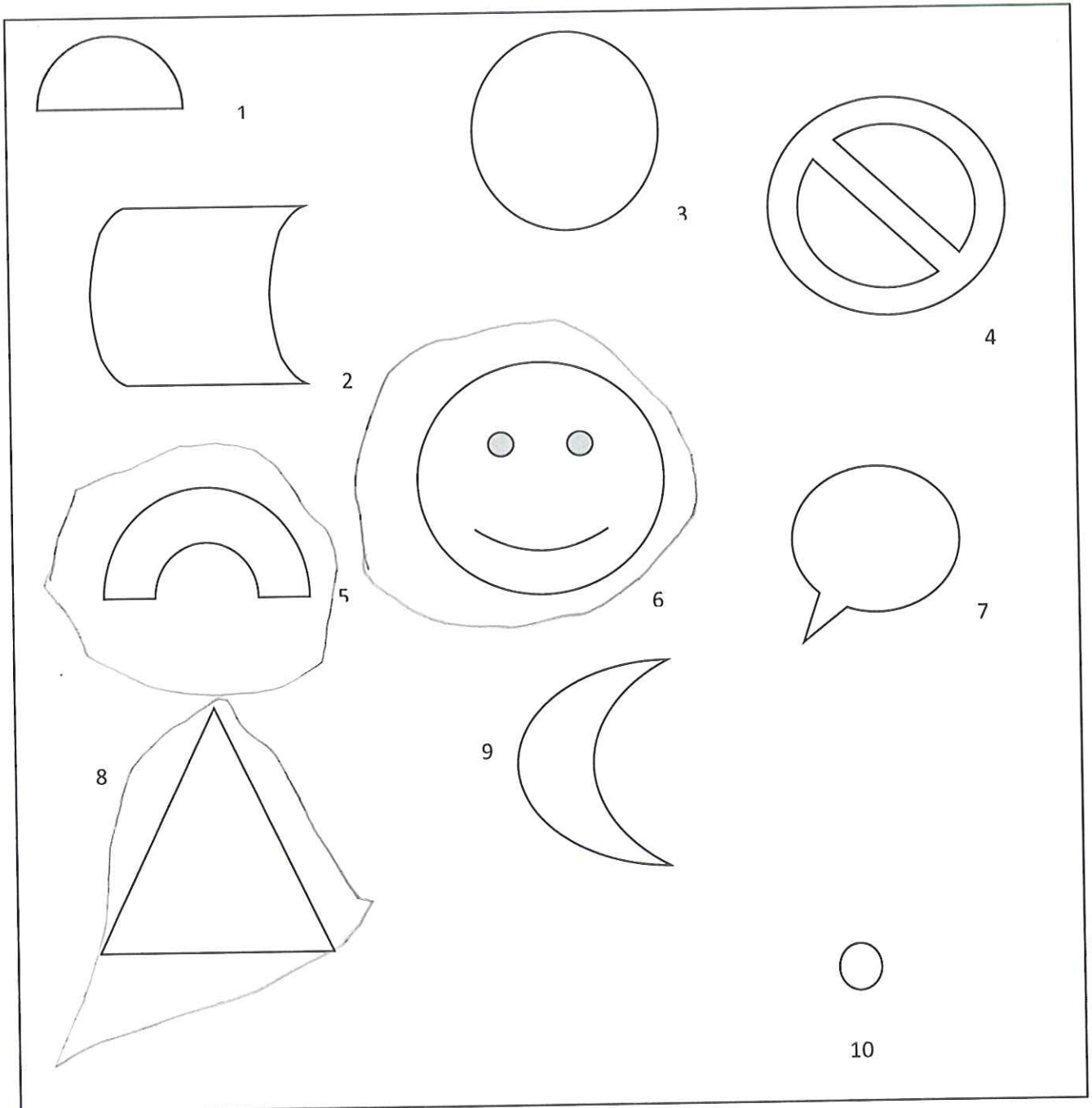

• ENCERCLA ELS QUADRATS

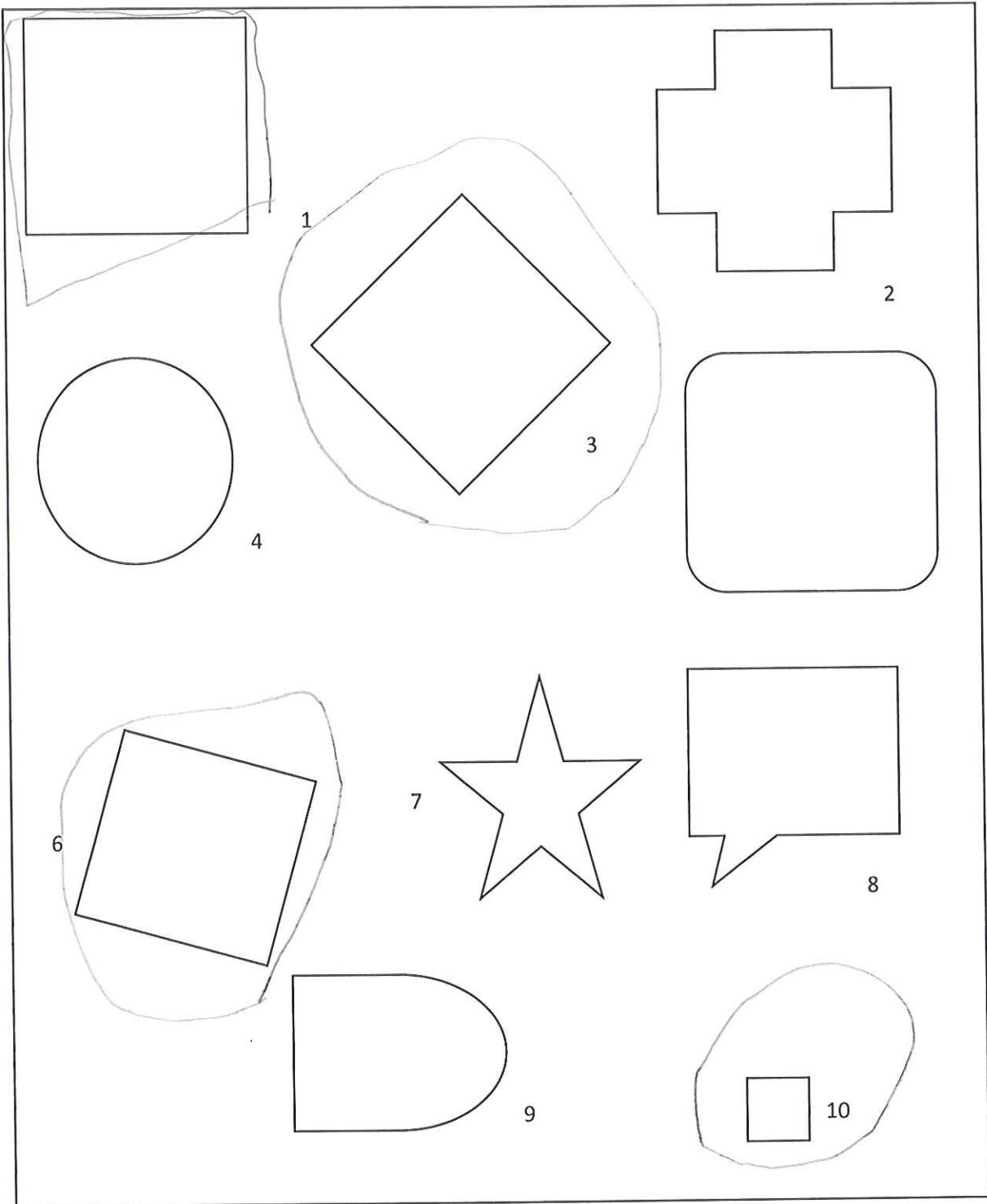

- ENCERCLA ELS RECTANGLES

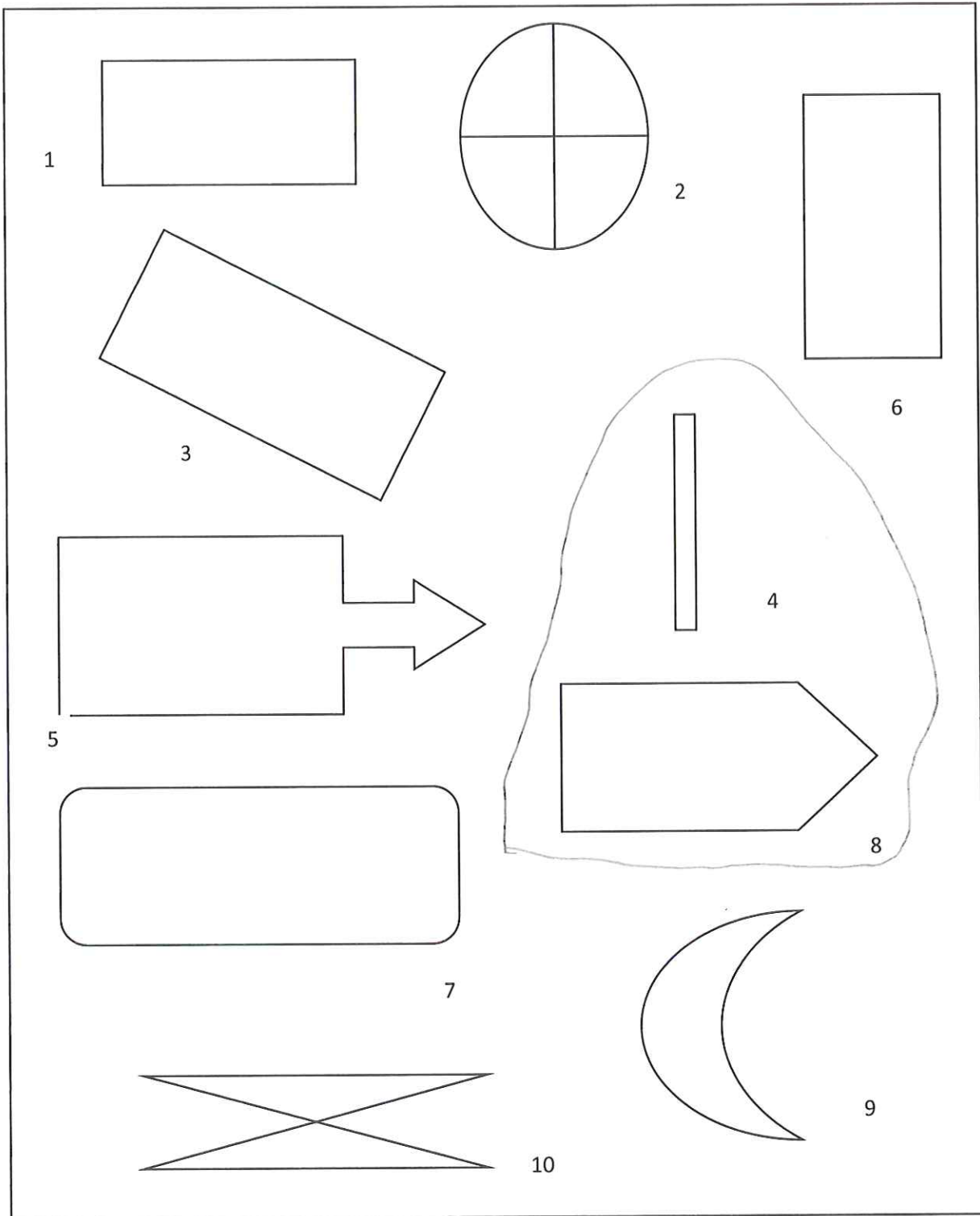

• ENCERCLA ELS TRIANGLES

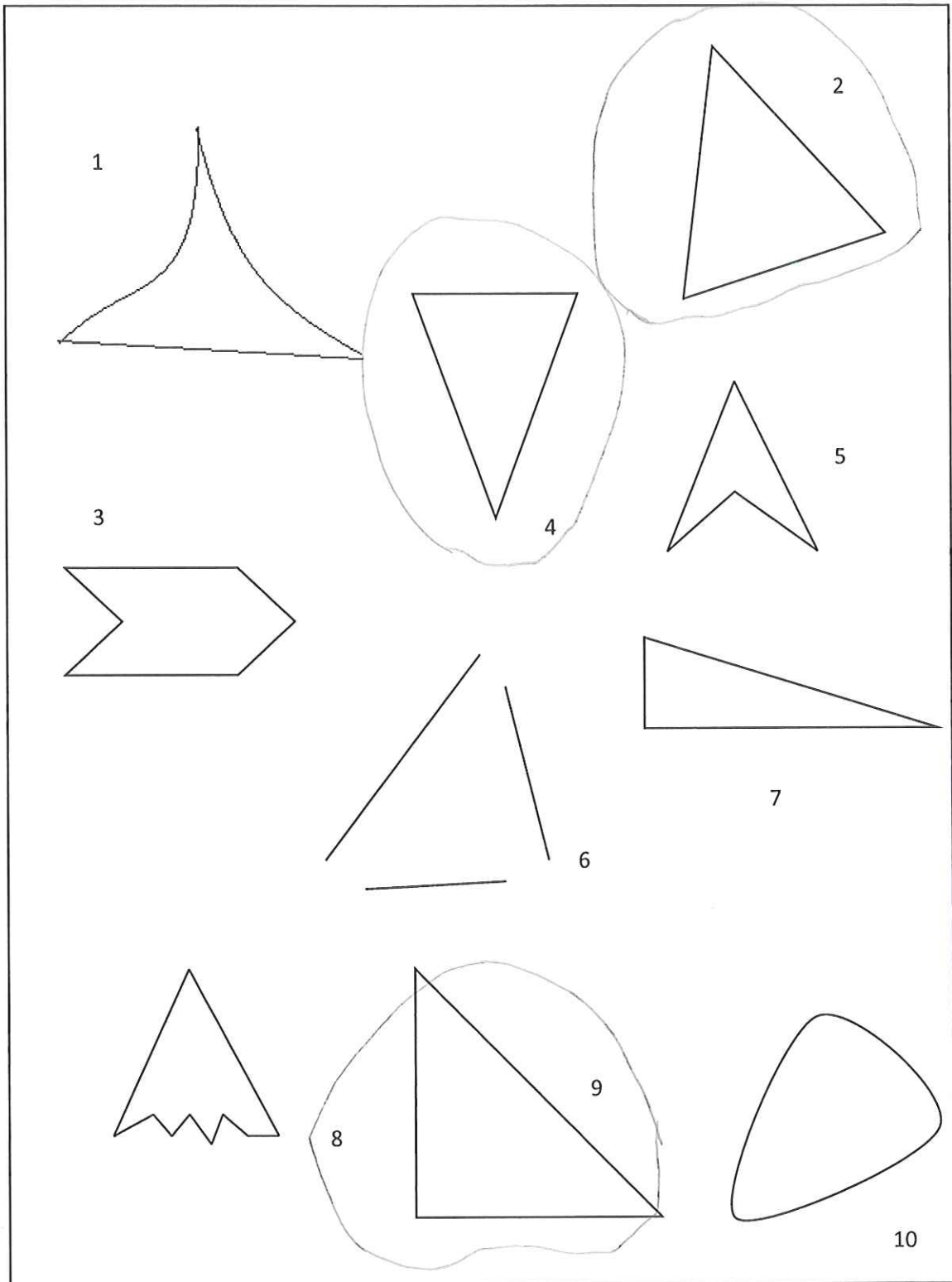

TEST PELS INFANTS DE P4B



1. DIBUIXA UN QUADRAT

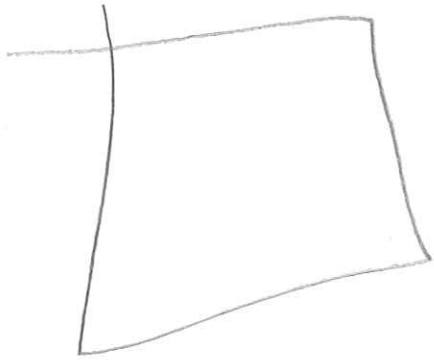

2. DIBUIXA UN RECTANGLE



3. DIBUIXA UN TRIANGLE

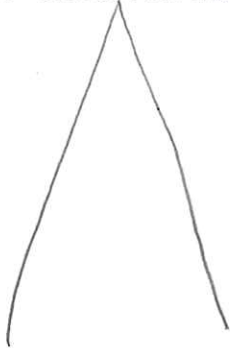

4. DIBUIXA UN CERCLE



5. QUANTS COSTATS TENEN AQUESTES FIGURES GEOMÈTRIQUES I VÈRTEXS



Costats

Vèrtexs

4

4

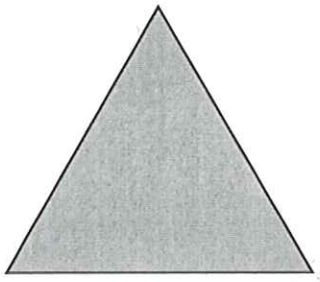

3

3



11

14



5

4

6. IDENTIFICA I ENCERCLA LES FIGURES GEOMÈTRIQUES.

- ENCERCLA ELS CERCLES

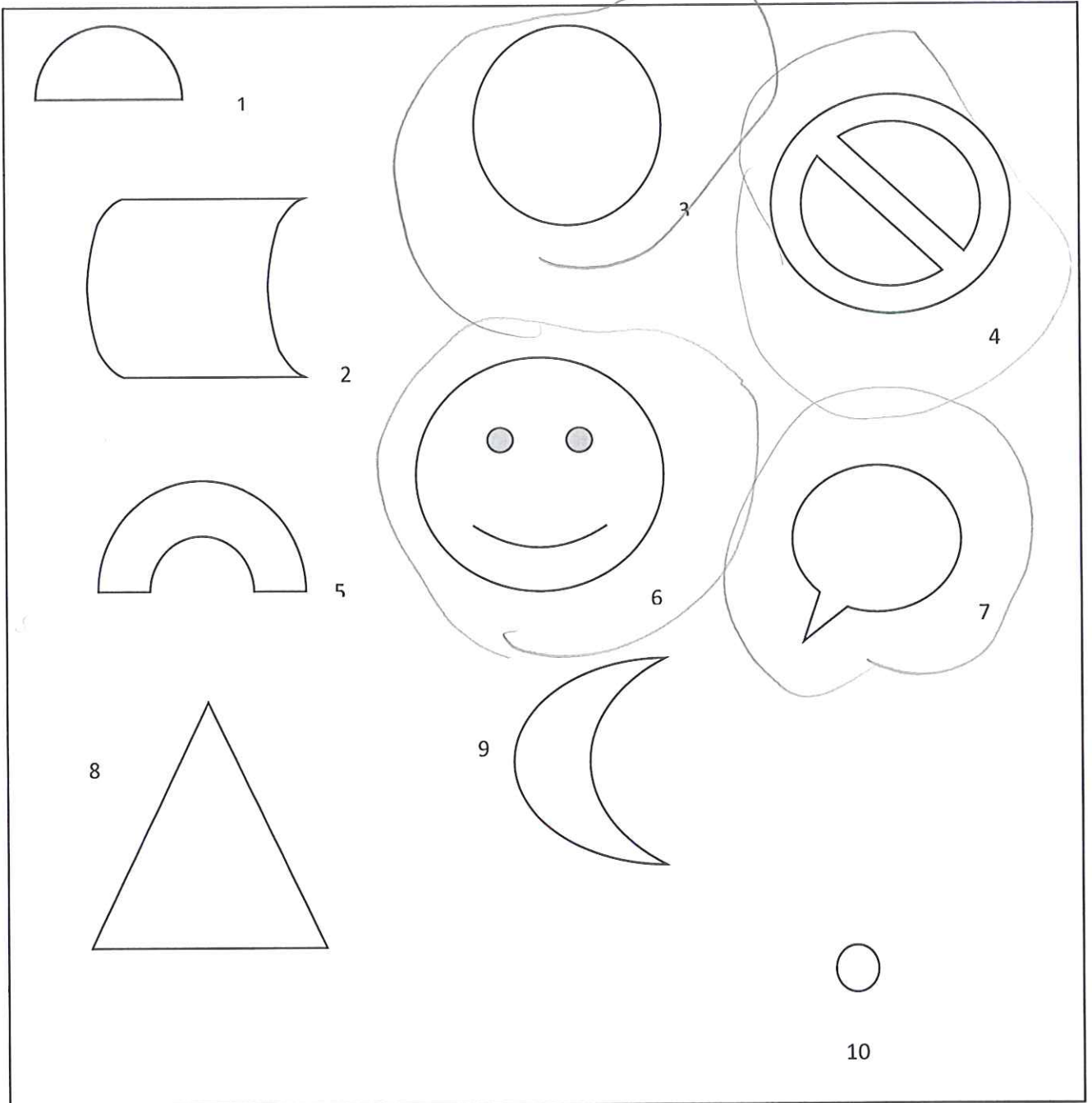

• ENCERCLA ELS QUADRATS

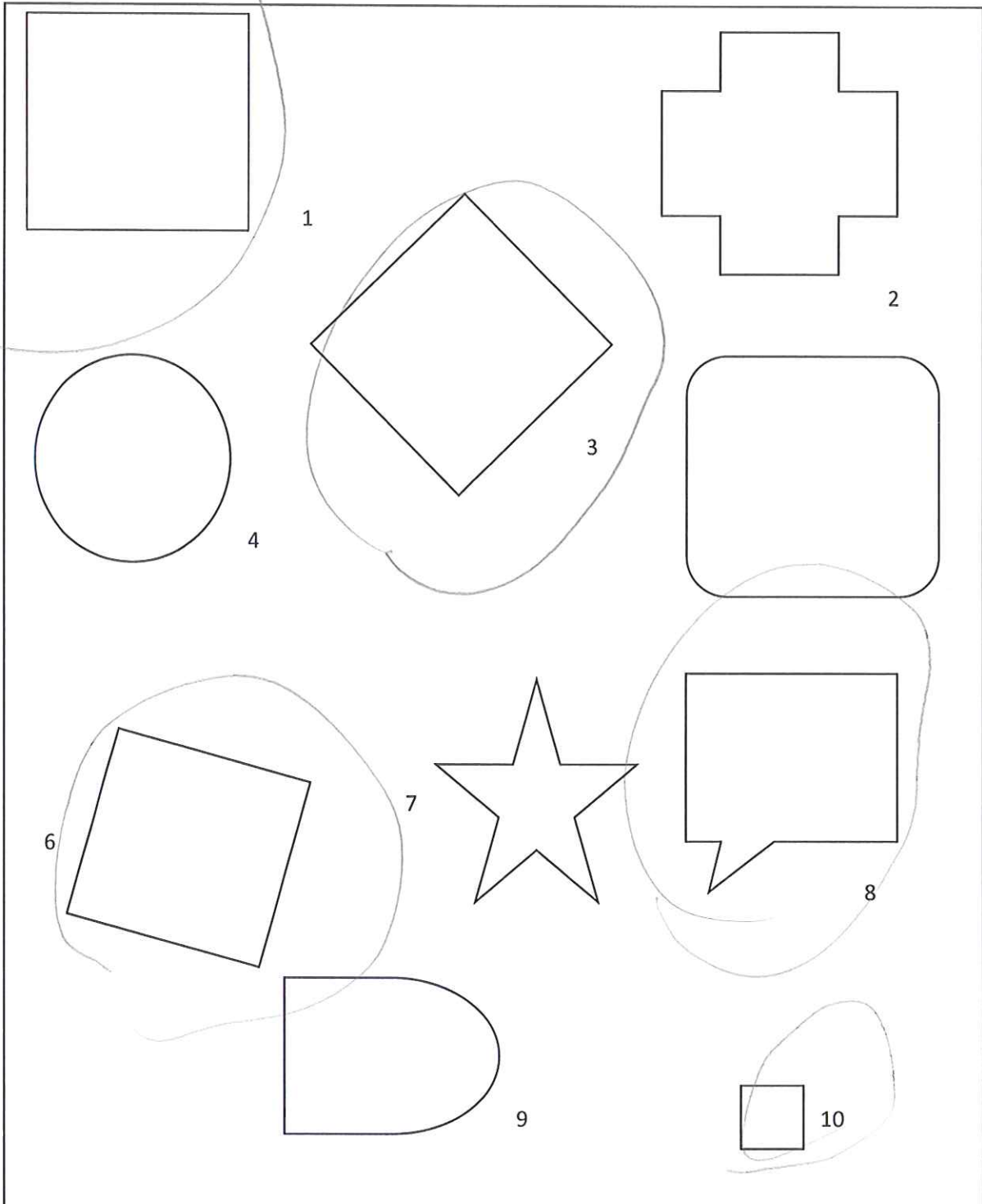

• ENCERCLA ELS RECTANGLES

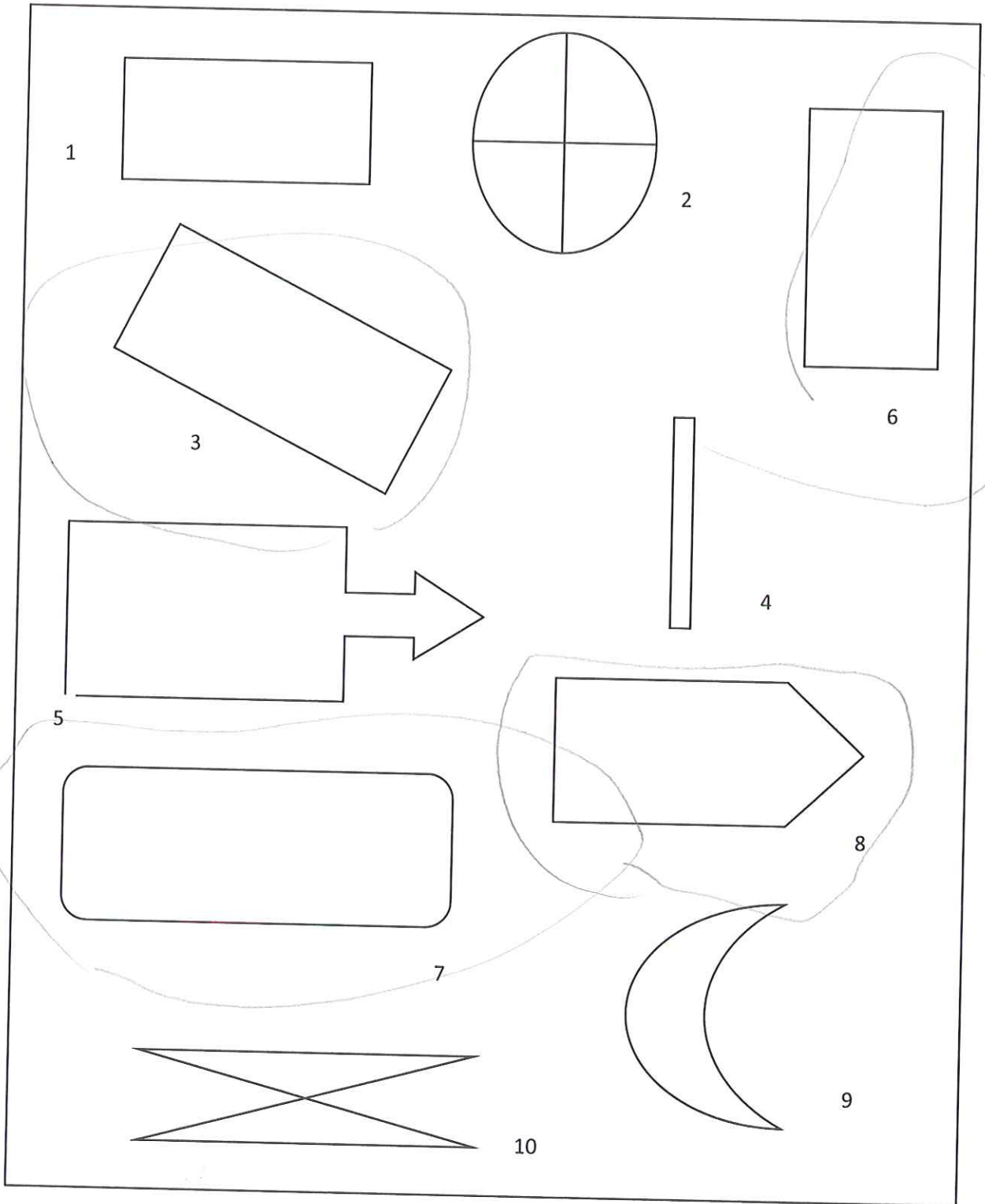

• ENCERCLA ELS TRIANGLES

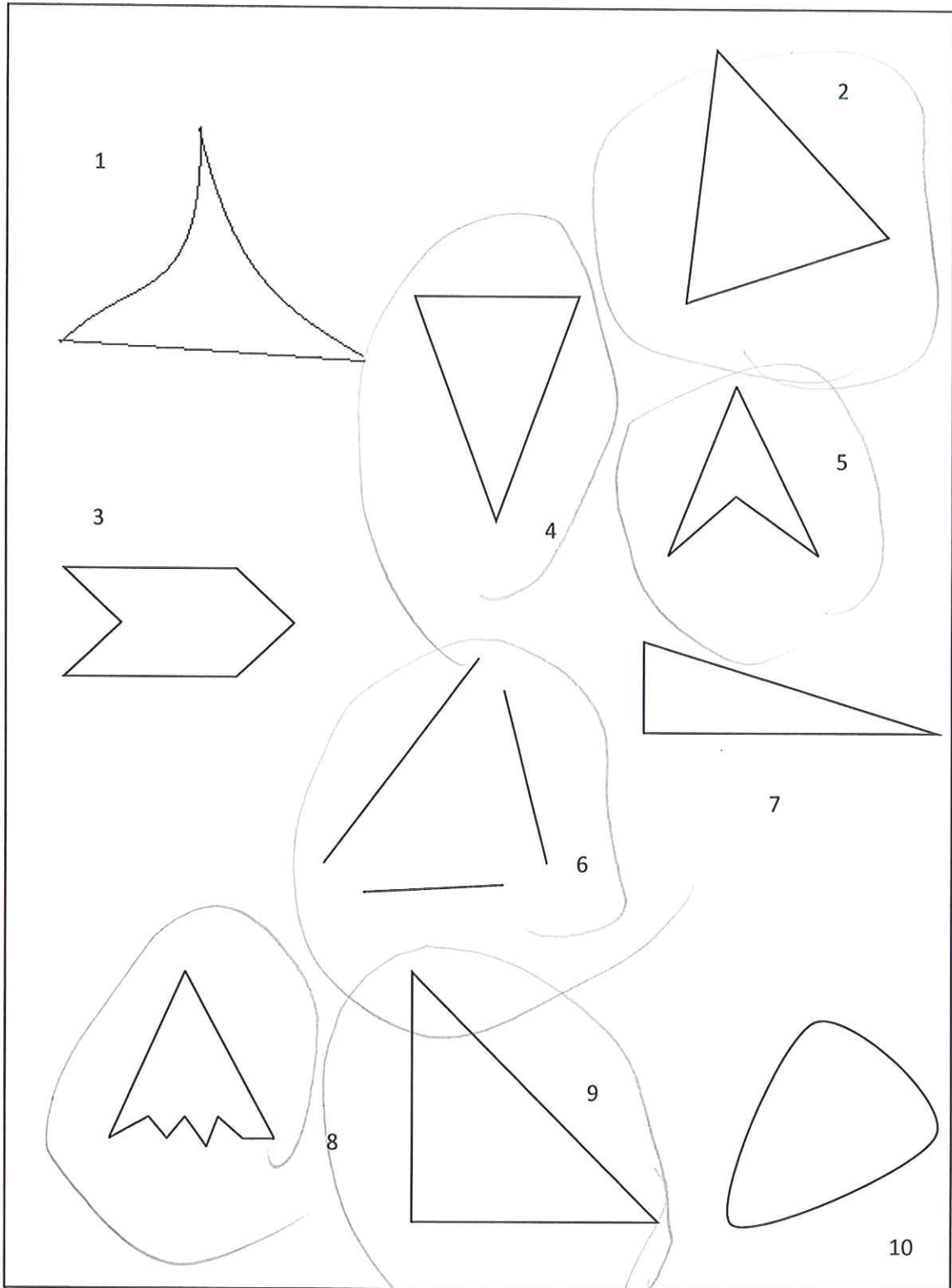

TEST PELS INFANTS DE P4B

1. DIBUIXA UN QUADRAT



2. DIBUIXA UN RECTANGLE



3. DIBUIXA UN TRIANGLE

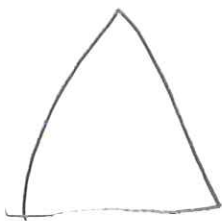

4. DIBUIXA UN CERCLE



5. QUANTS COSTATS TENEN AQUESTES FIGURES GEOMÈTRIQUES I VÈRTEXS



Costats Vèrtexs

4

4

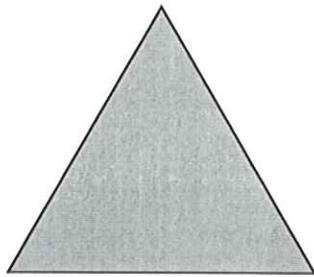

3

3



4

2



4

4

6. IDENTIFICA I ENCERCLA LES FIGURES GEOMÈTRIQUES.

- ENCERCLA ELS CERCLES

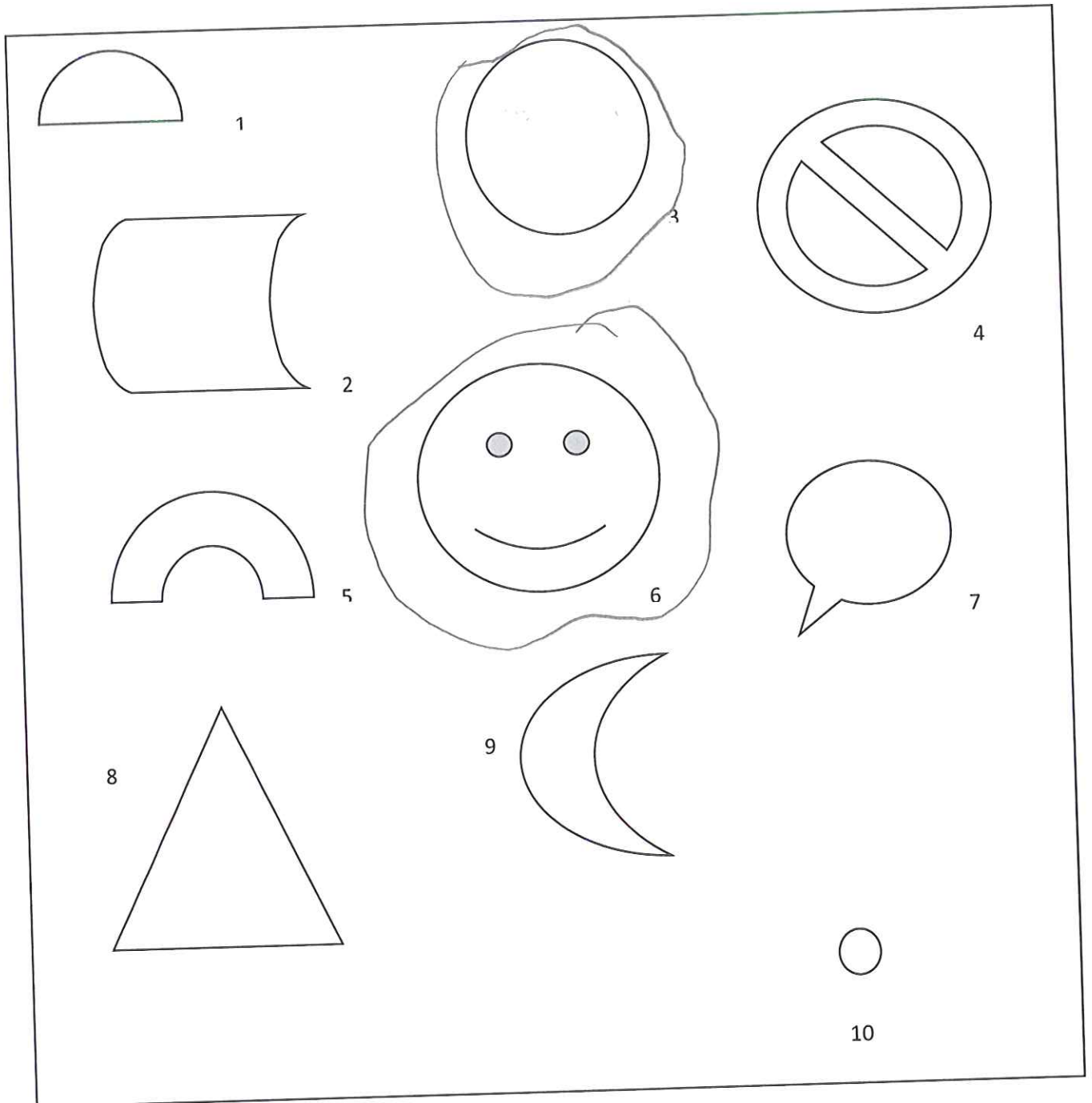

• ENCERCLA ELS QUADRATS

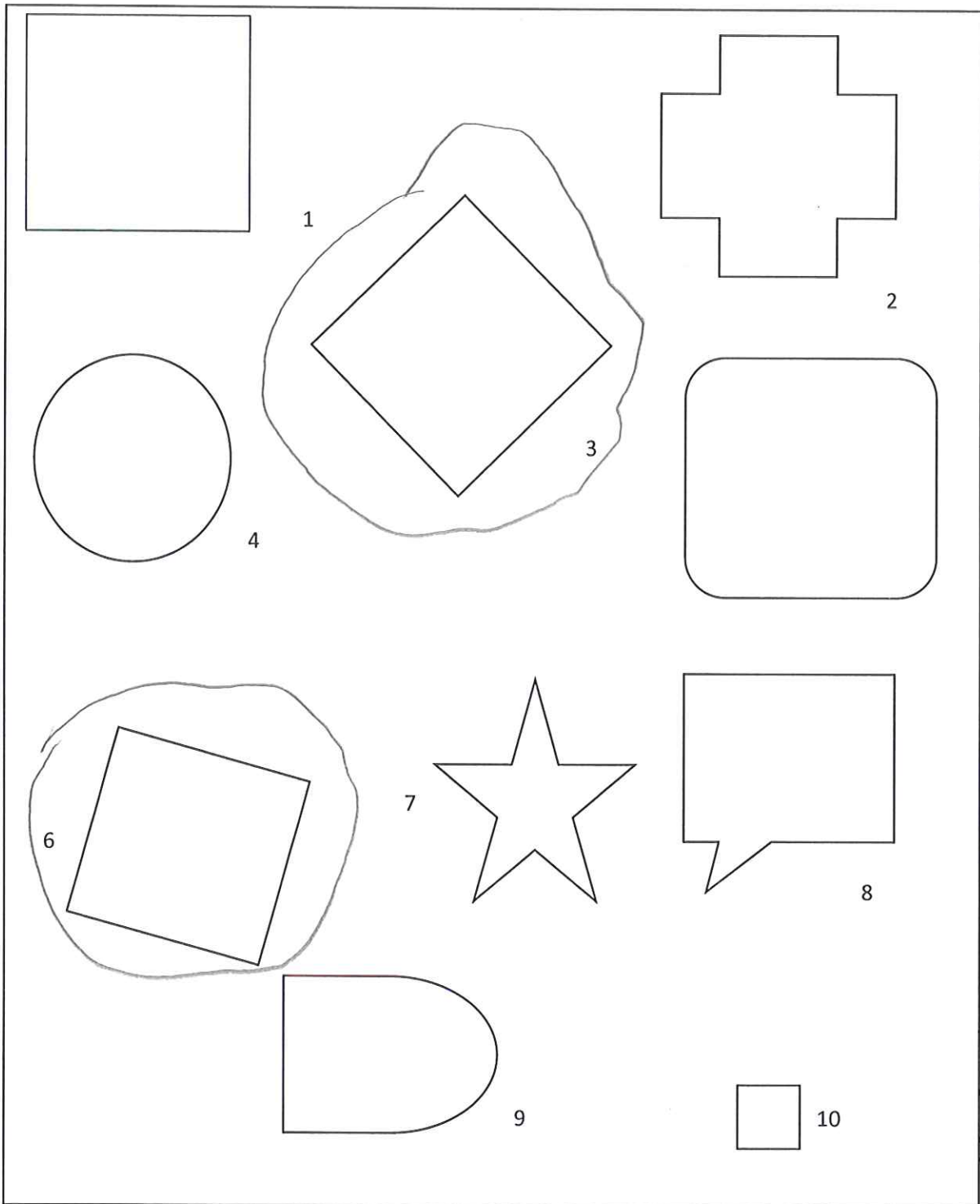

• ENCERCLA ELS RECTANGLES

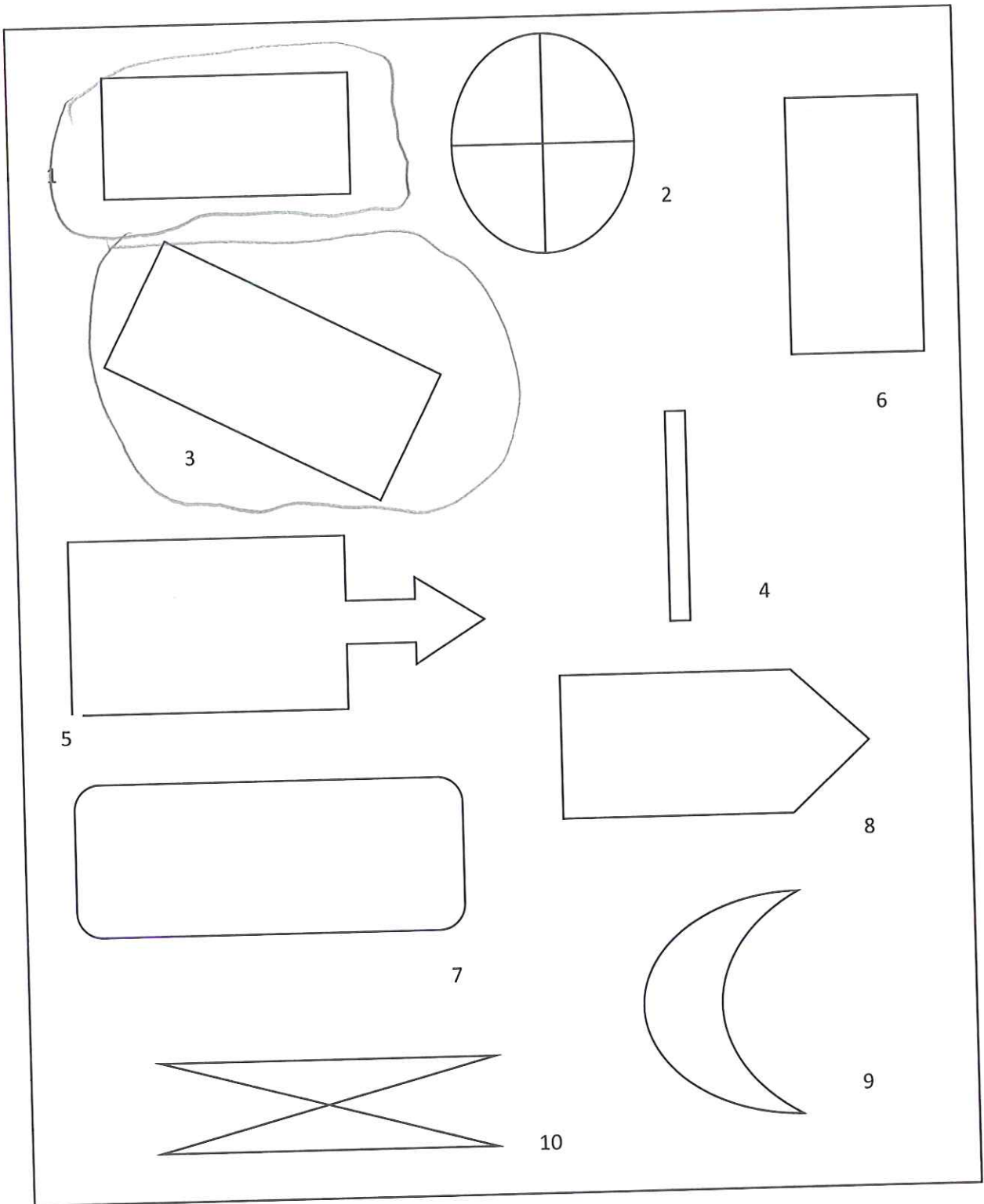

• ENCERCLA ELS TRIANGLES

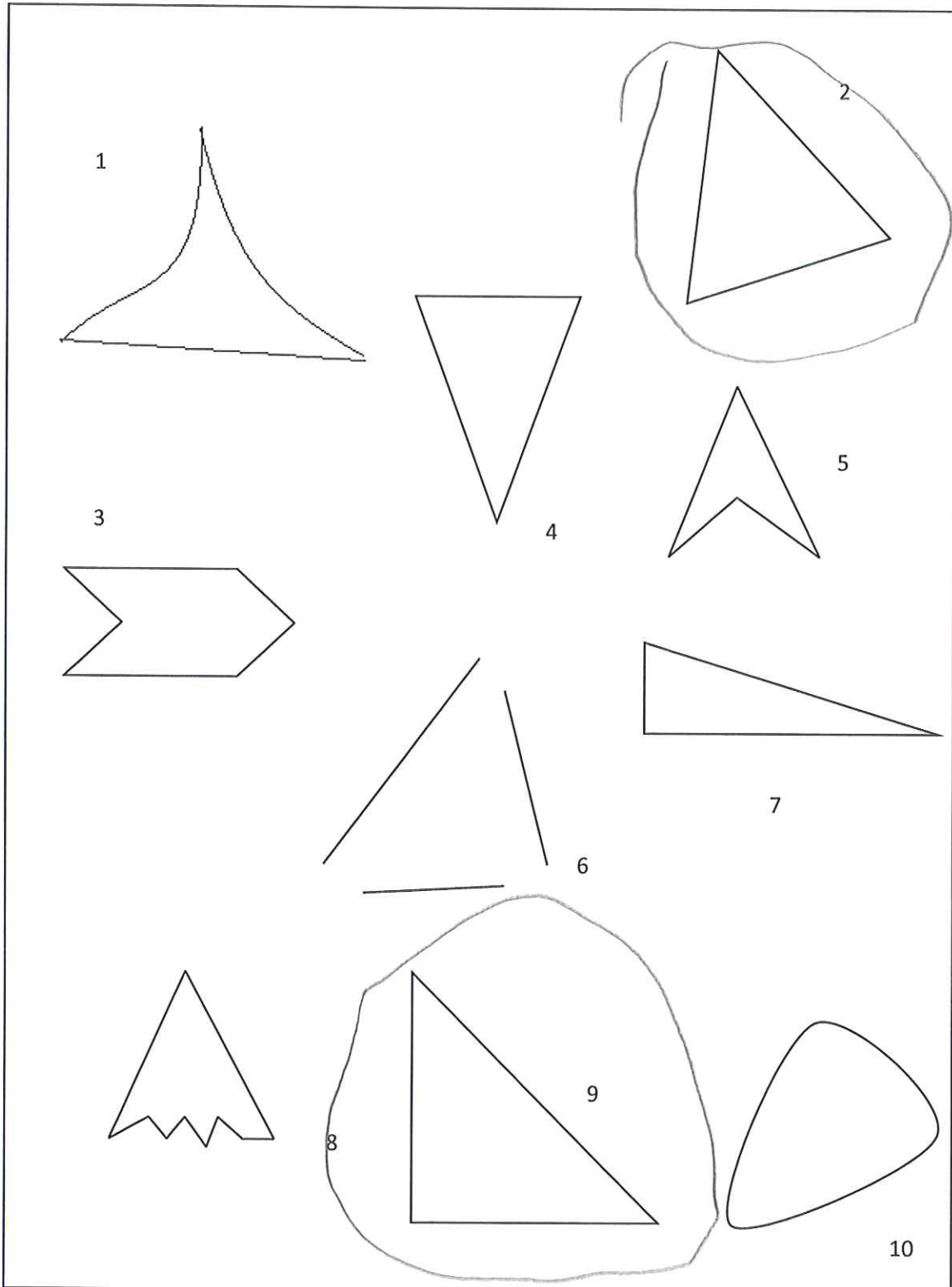

TEST PELS INFANTS DE P4B

1. DIBUIXA UN QUADRAT

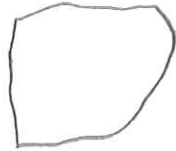

2. DIBUIXA UN RECTANGLE



3. DIBUIXA UN TRIANGLE

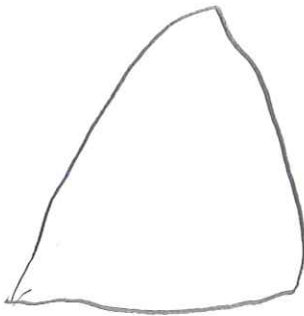

4. DIBUIXA UN CERCLE



5. QUANTS COSTATS TENEN AQUESTES FIGURES GEOMÈTRIQUES I VÈRTEXS

costats

vèrtexs



4

4

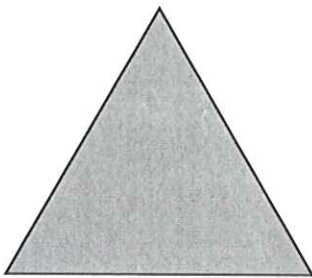

3

3



0

0



4

4

6. IDENTIFICA I ENCERCLA LES FIGURES GEOMÈTRIQUES.

- ENCERCLA ELS CERCLES

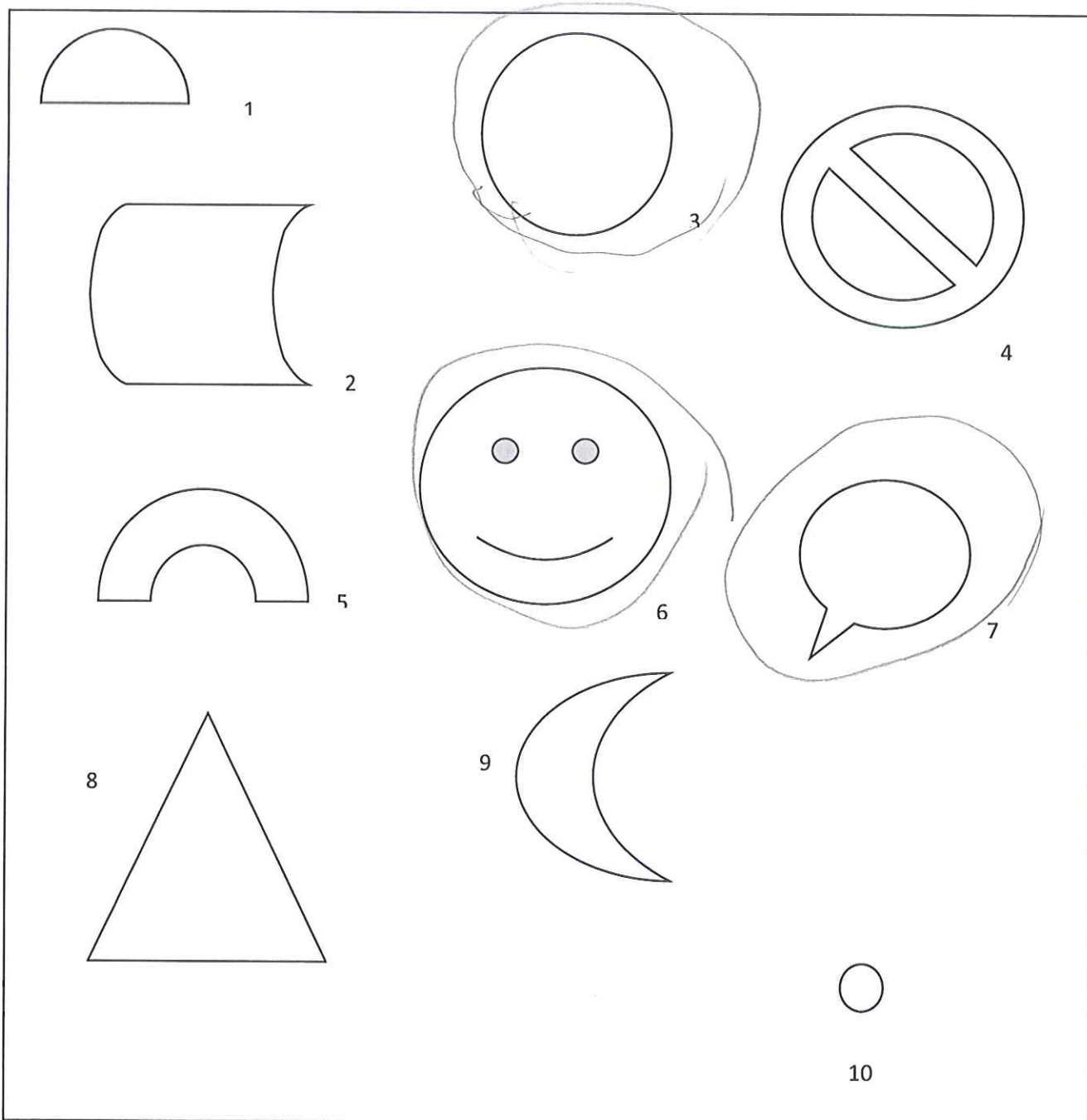

• ENCERCLA ELS QUADRATS

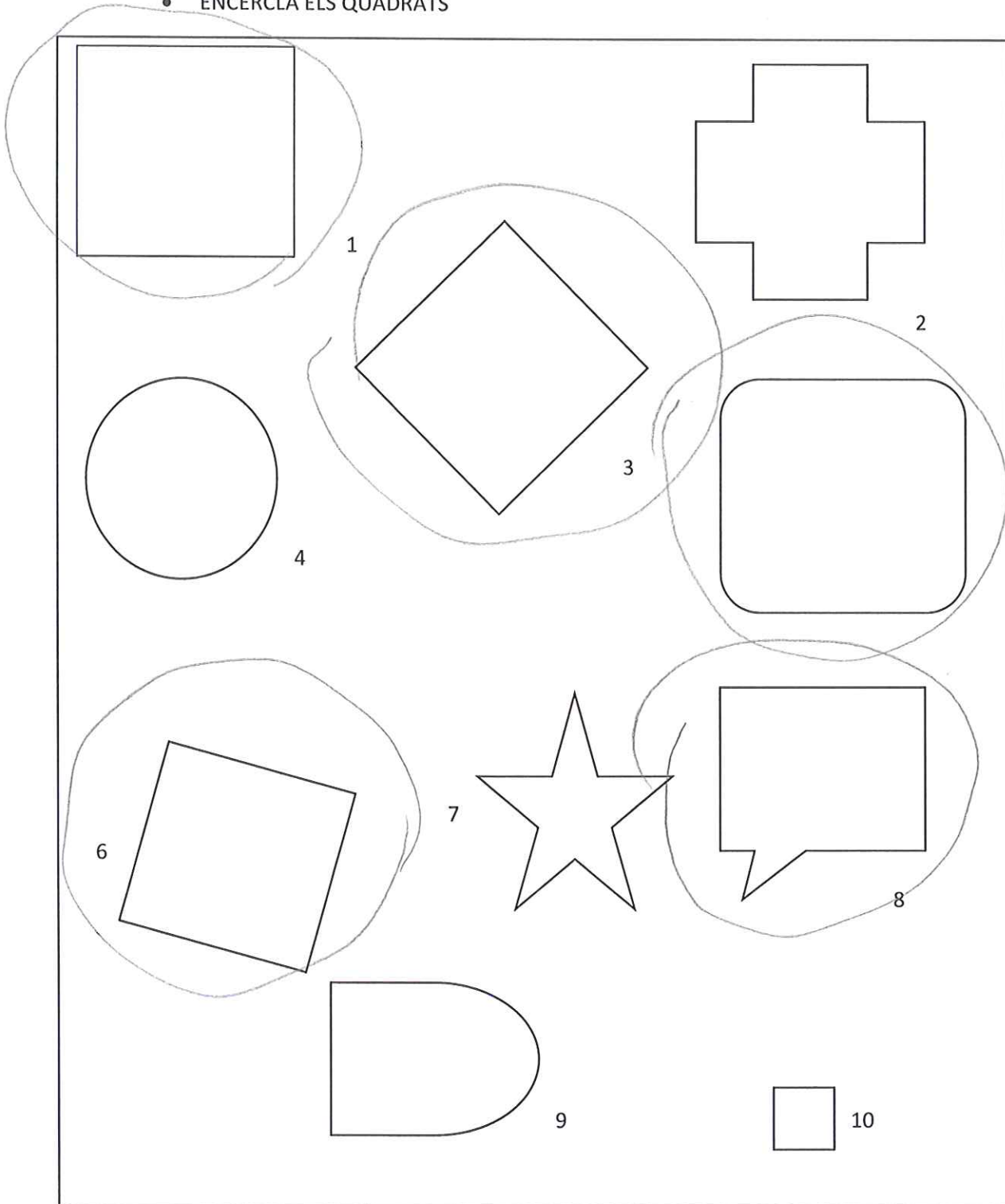

5

- ENCERCLA ELS RECTANGLES

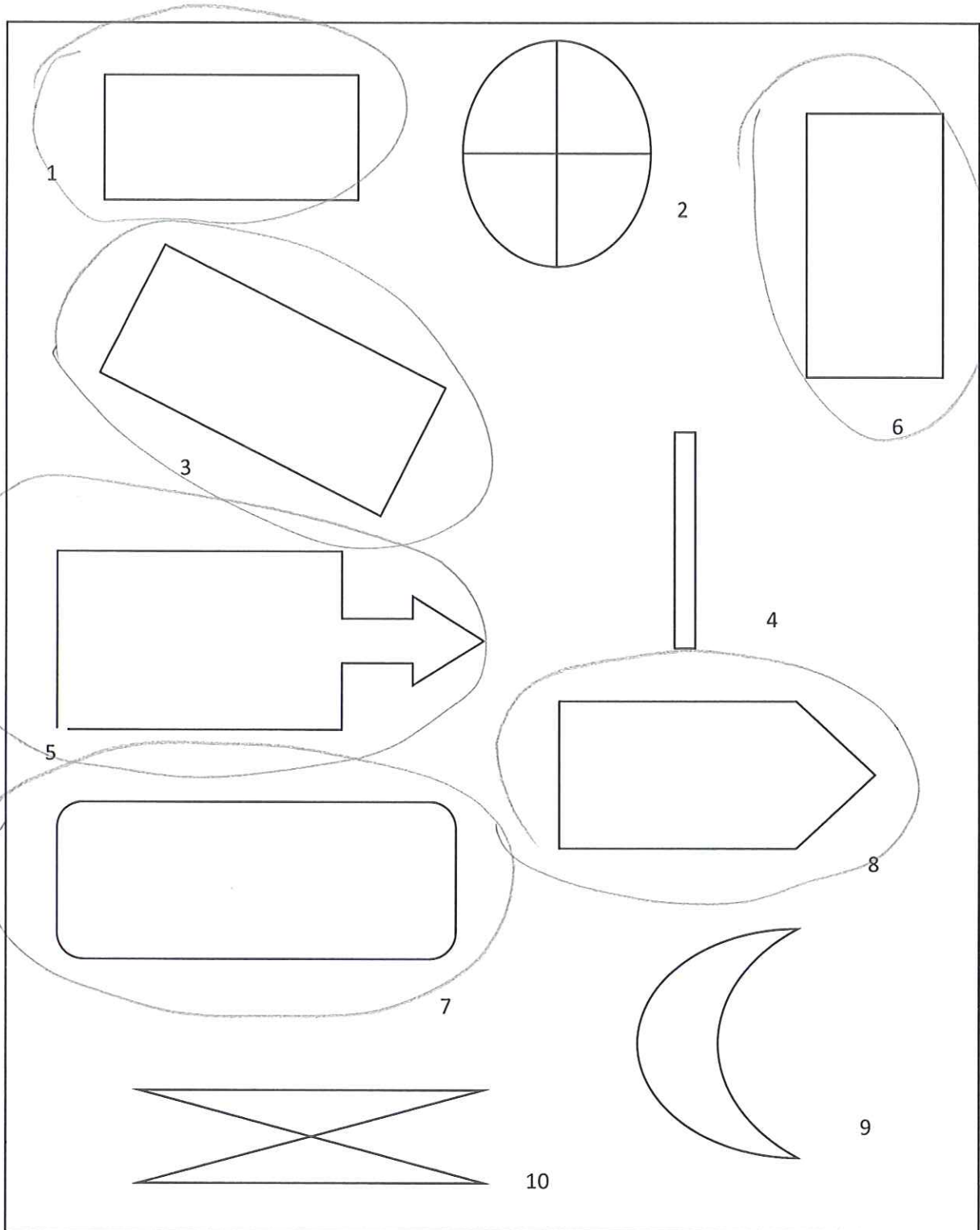

• ENCERCLA ELS TRIANGLES

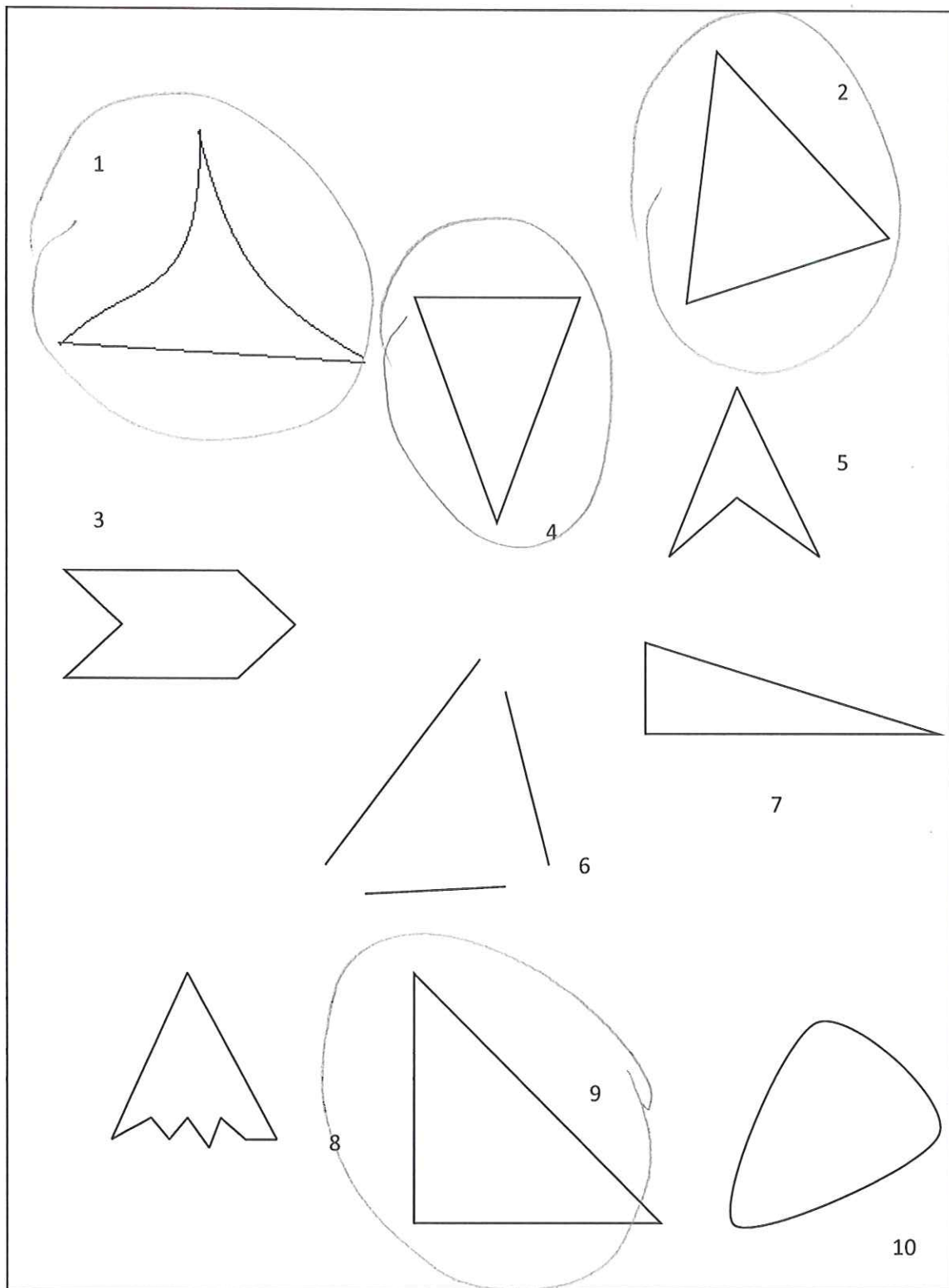

TEST PELS INFANTS DE P4B

1. DIBUIXA UN QUADRAT

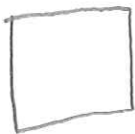

2. DIBUIXA UN RECTANGLE



3. DIBUIXA UN TRIANGLE

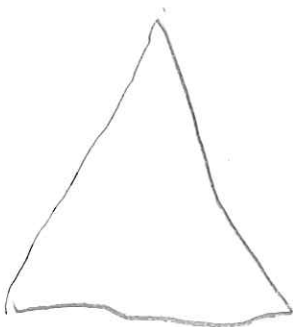

4. DIBUIXA UN CERCLE



5. QUANTS COSTATS TENEN AQUESTES FIGURES GEOMÈTRIQUES I VÈRTEXS

Costats

Vèrteixs

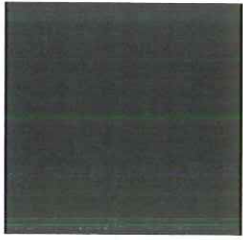

0

4

4

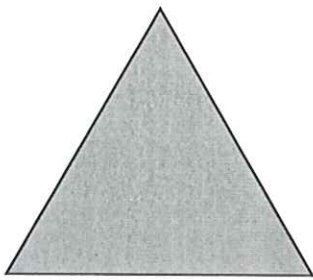

3

3



0

0



4

4

6. IDENTIFICA I ENCERCLA LES FIGURES GEOMÈTRIQUES.

- ENCERCLA ELS CERCLES

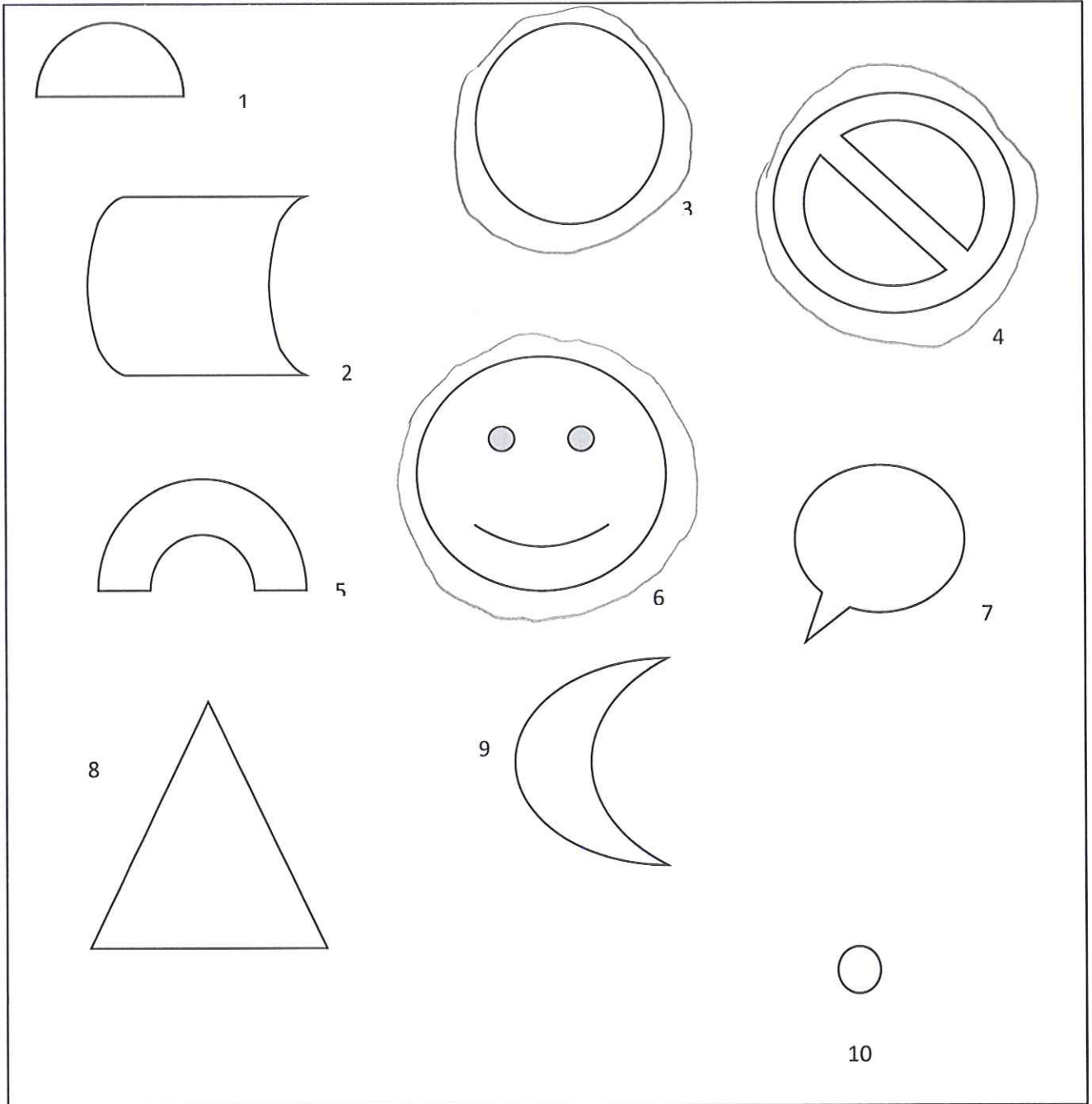

• ENCERCLA ELS QUADRATS

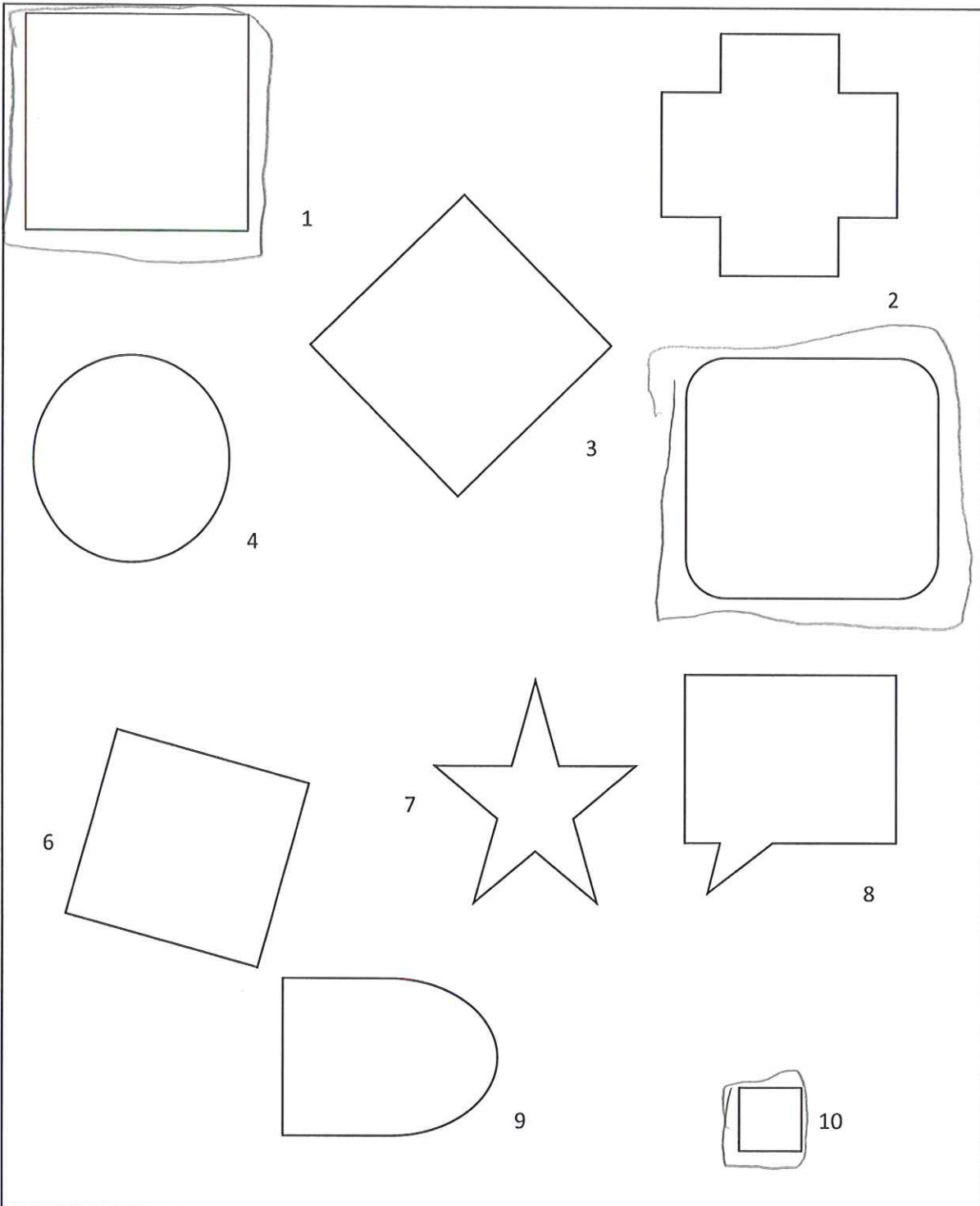

• ENCERCLA ELS RECTANGLES

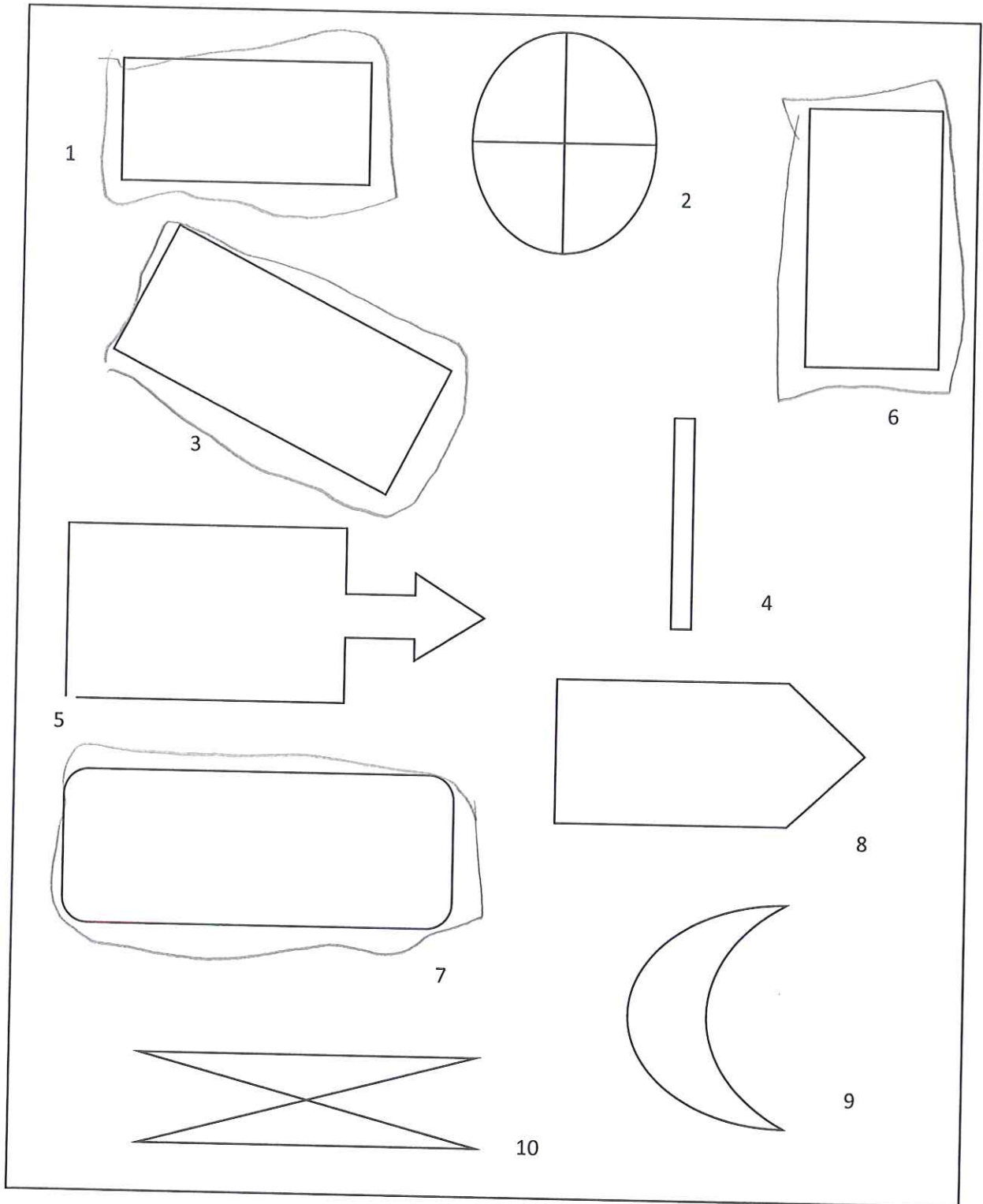

• ENCERCLA ELS TRIANGLES

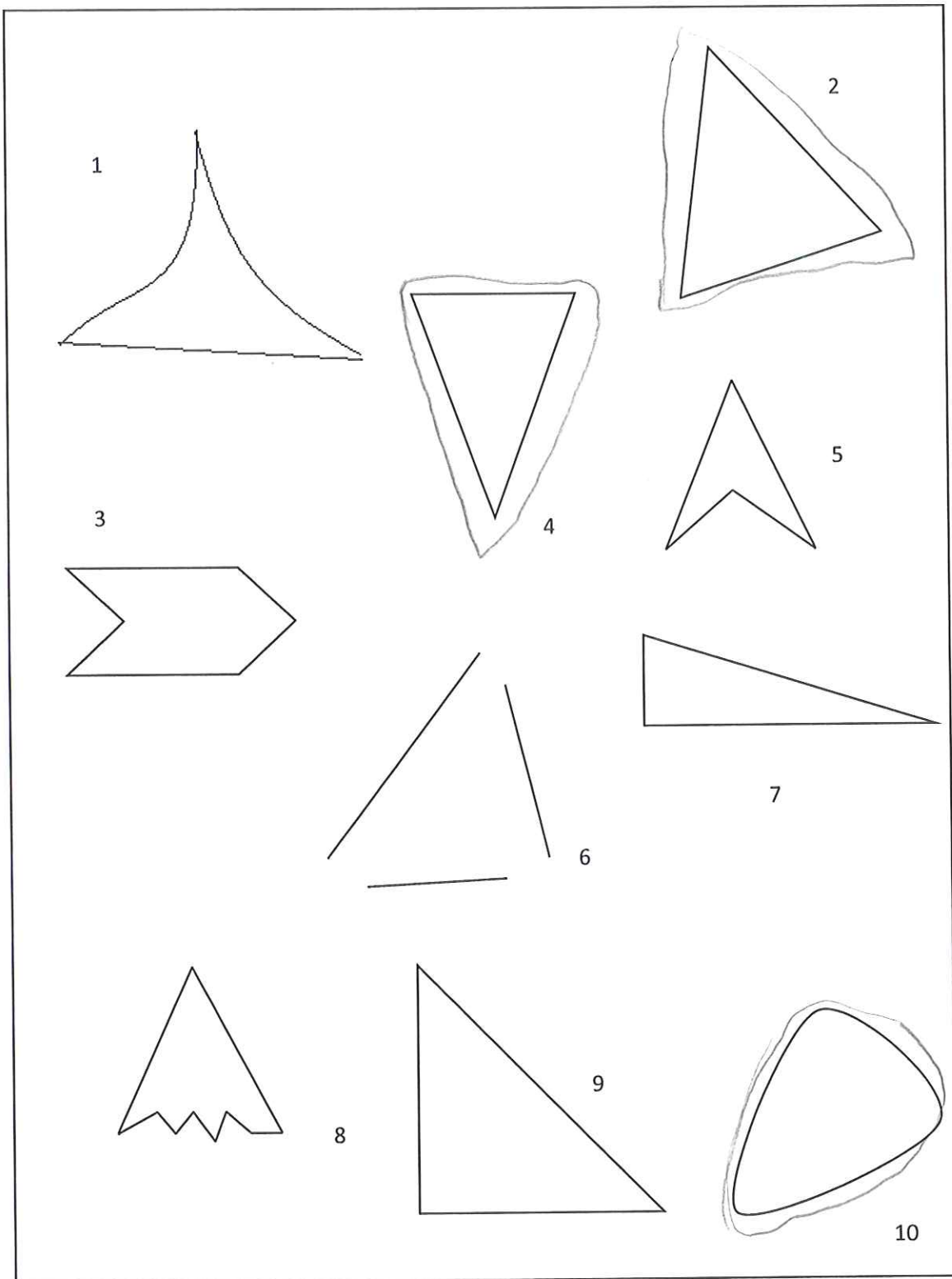

TEST PELS INFANTS DE P4B

1. DIBUIXA UN QUADRAT



2. DIBUIXA UN RECTANGLE



3. DIBUIXA UN TRIANGLE



4. DIBUIXA UN CERCLE



5. QUANTS COSTATS TENEN AQUESTES FIGURES GEOMÈTRIQUES I VÈRTEXS



Costats

Vèrtexs

4

4

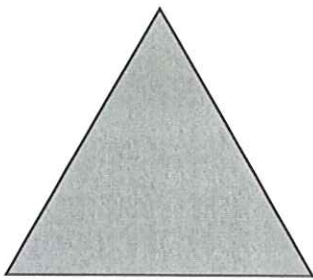

3

3



0

0



4

4

6. IDENTIFICA I ENCERCLA LES FIGURES GEOMÈTRIQUES.

- ENCERCLA ELS CERCLES

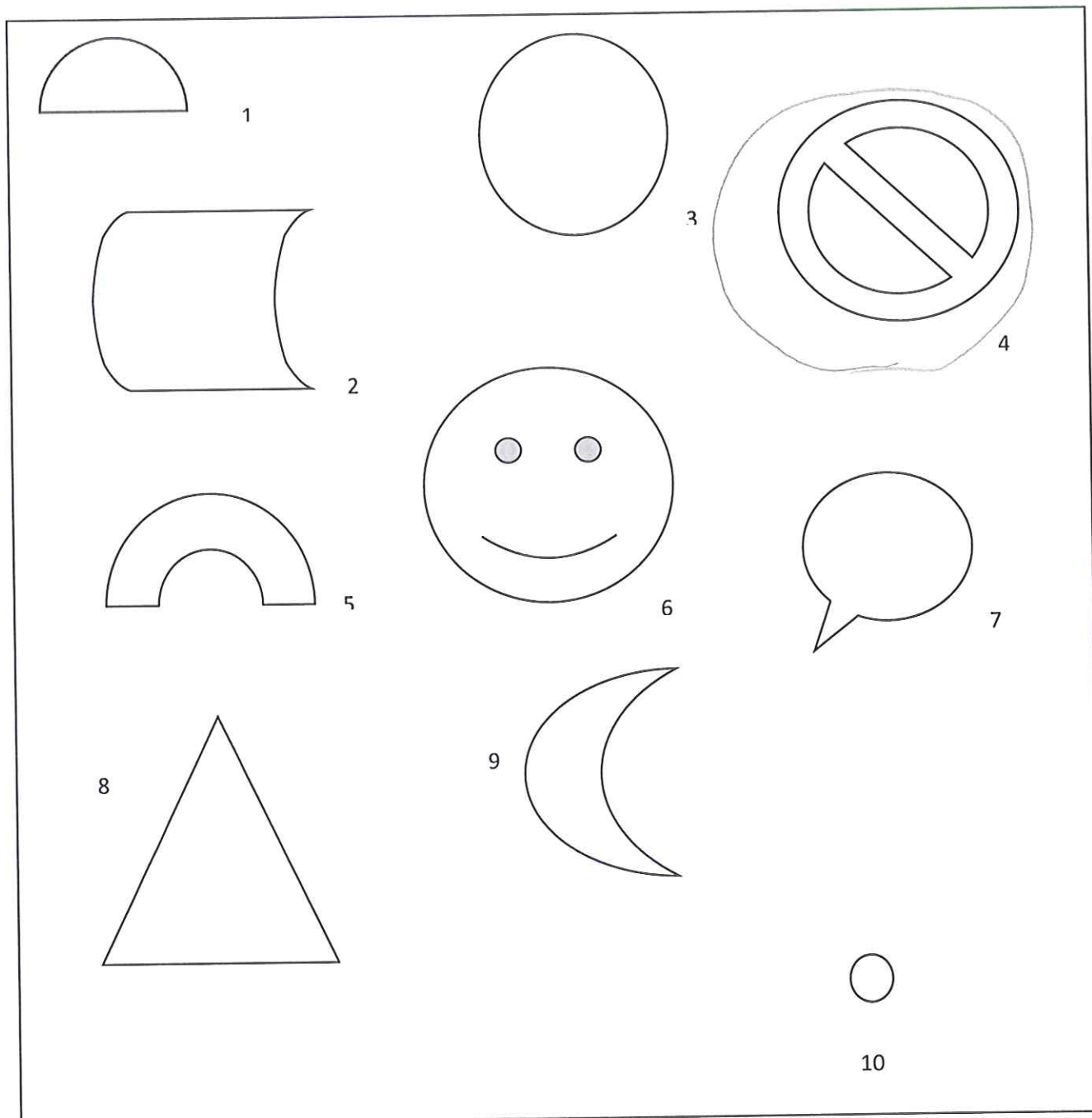

• ENCERCLA ELS QUADRATS

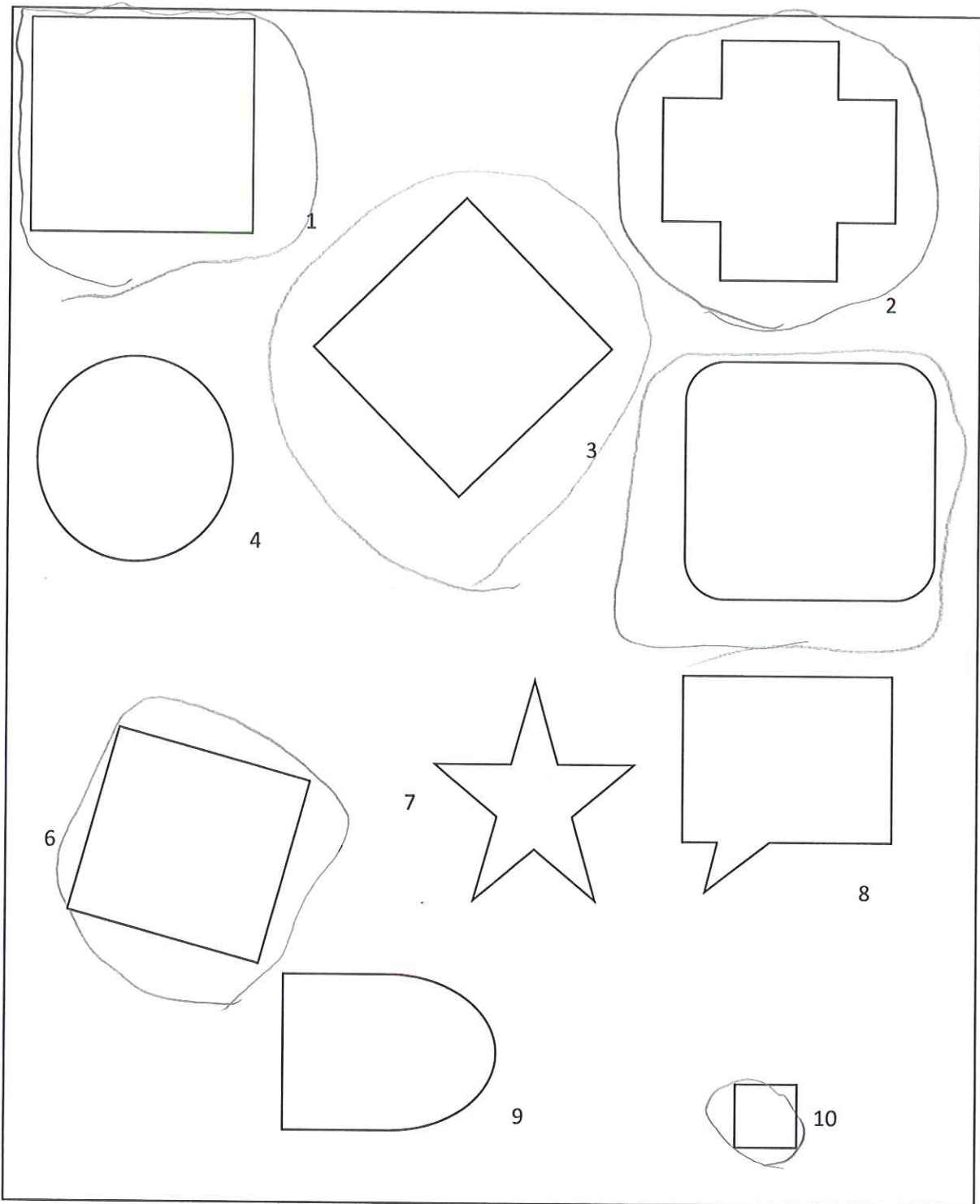

- ENCERCLA ELS RECTANGLES

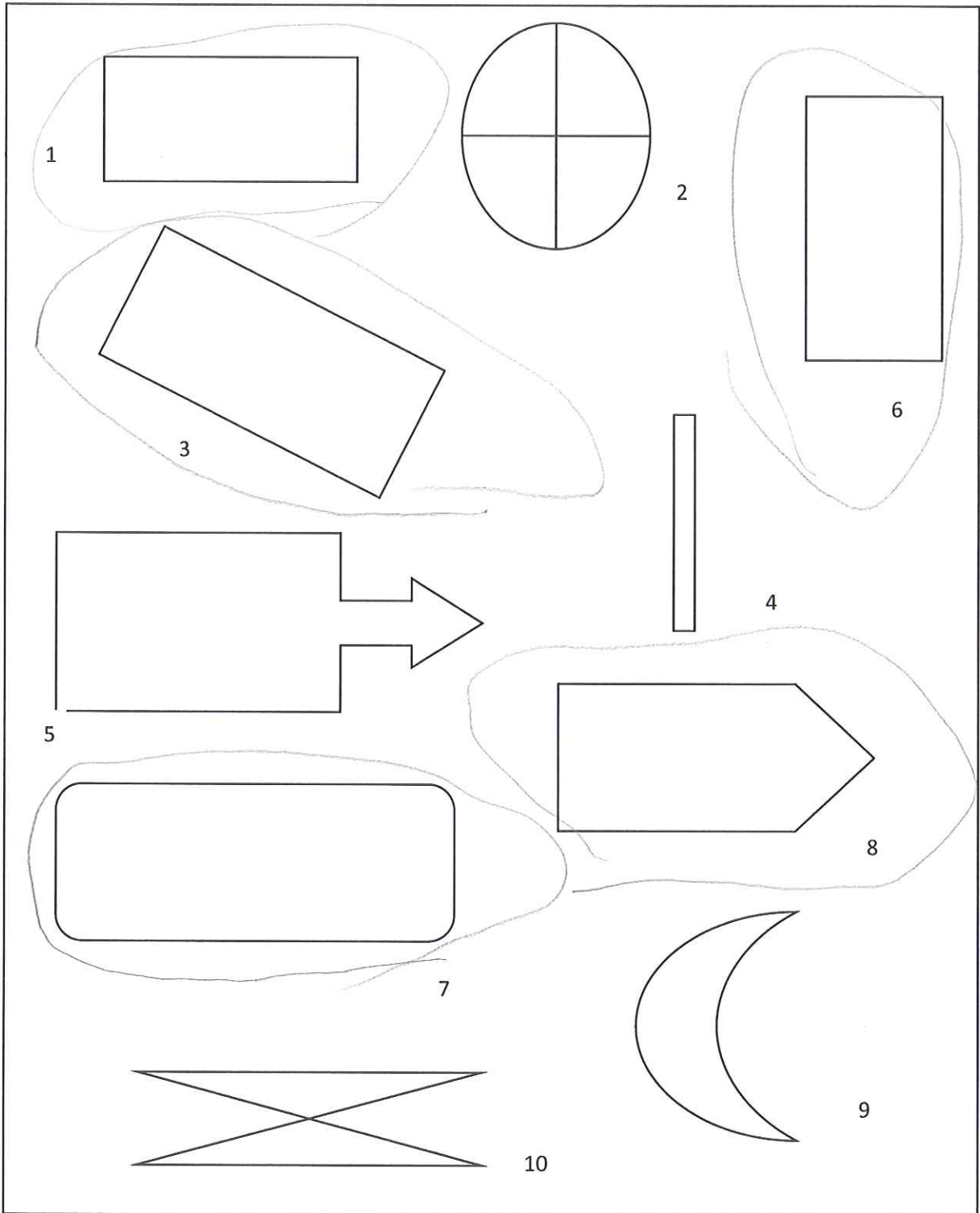

• ENCERCLA ELS TRIANGLES

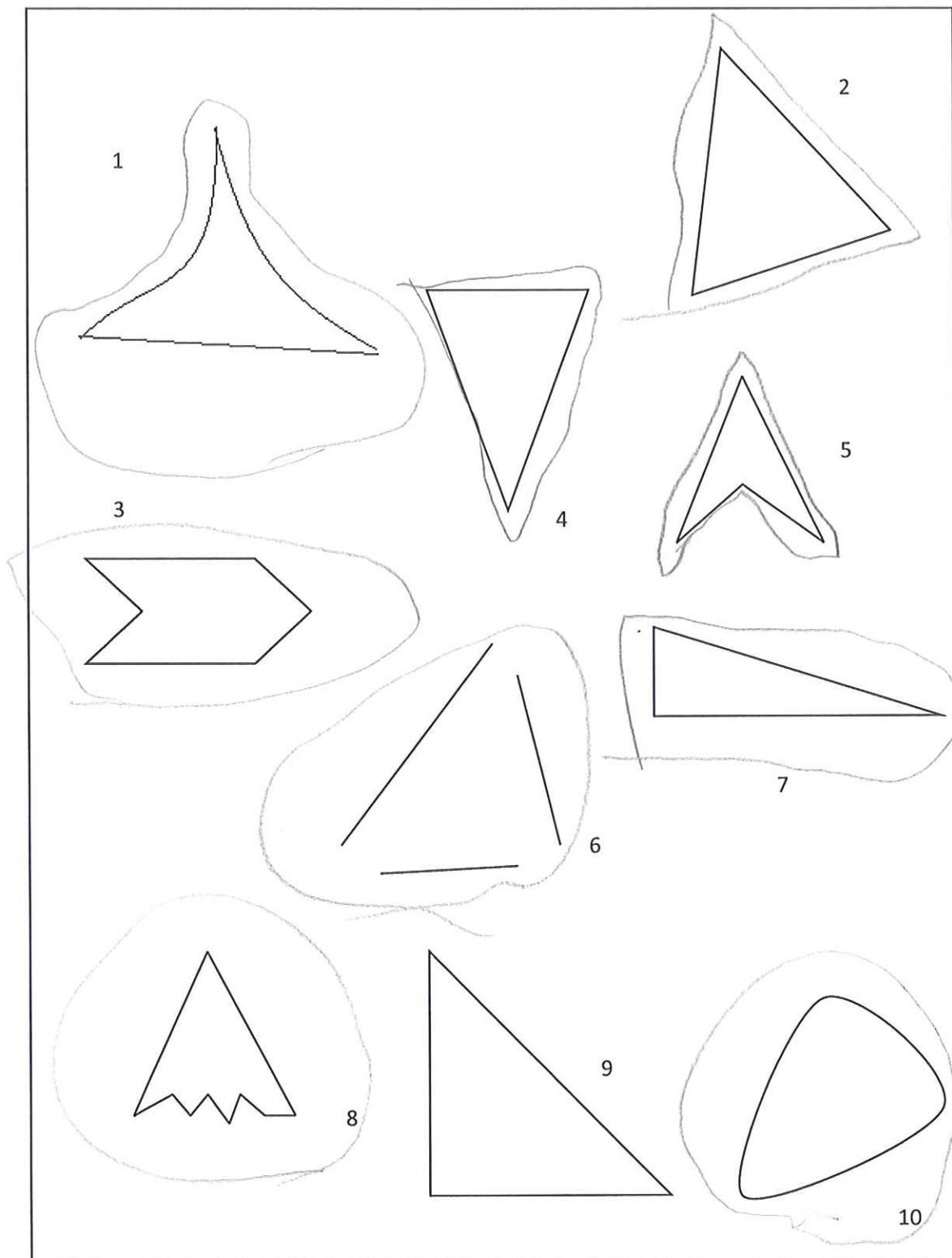

TEST PELS INFANTS DE P4B

1. DIBUIXA UN QUADRAT



2. DIBUIXA UN RECTANGLE



3. DIBUIXA UN TRIANGLE

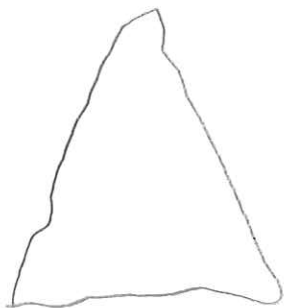

4. DIBUIXA UN CERCLE



5. QUANTS COSTATS TENEN AQUESTES FIGURES GEOMÈTRIQUES I VÈRTEXS



Costats

Vèrtexs

4

4

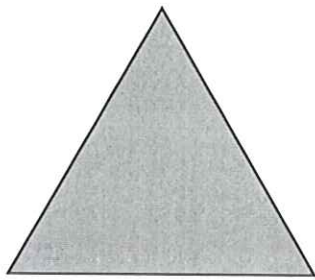

6

3



3

3



3

6

6. IDENTIFICA I ENCERCLA LES FIGURES GEOMÈTRIQUES.

- ENCERCLA ELS CERCLES

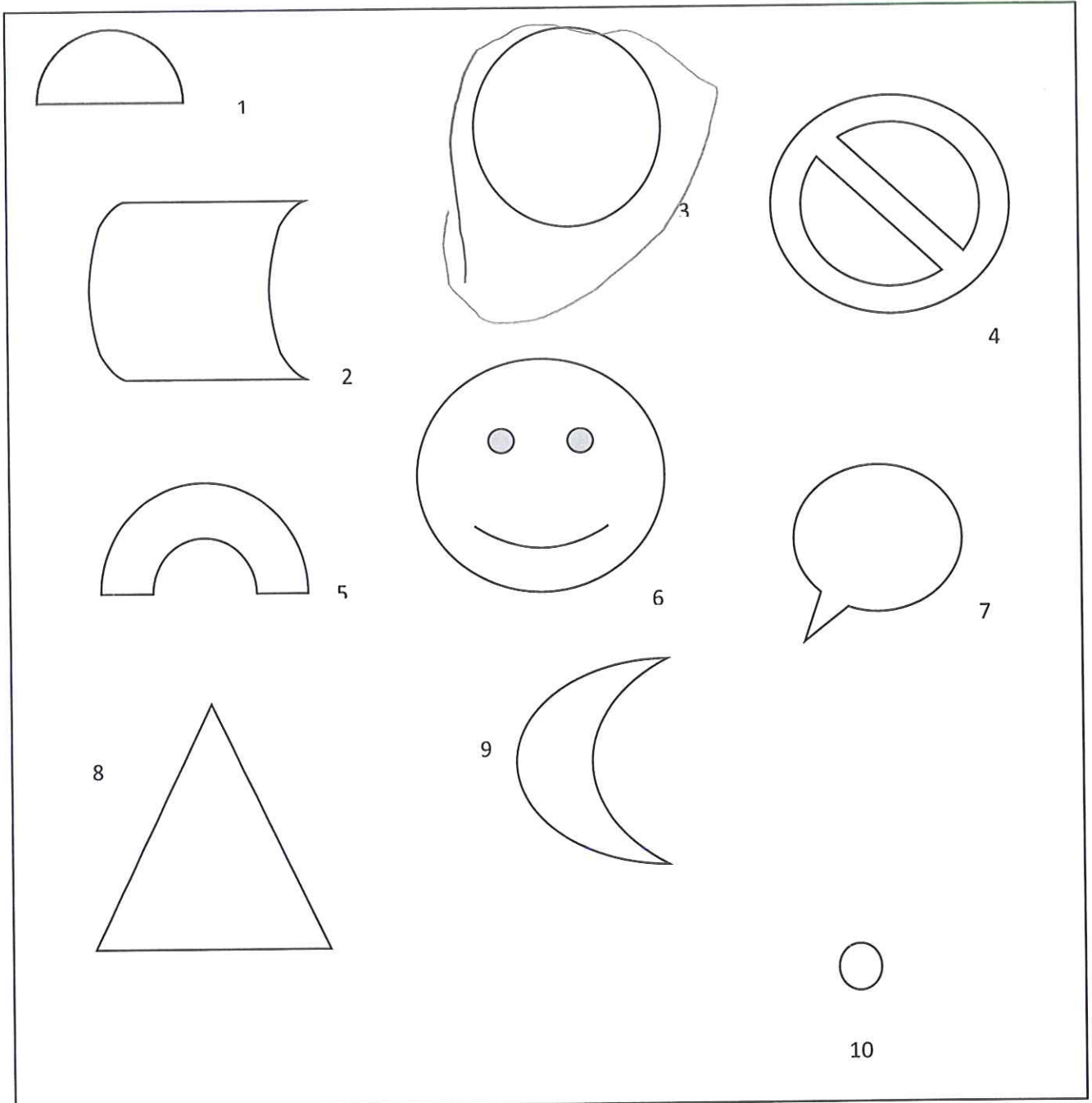

• ENCERCLA ELS QUADRATS

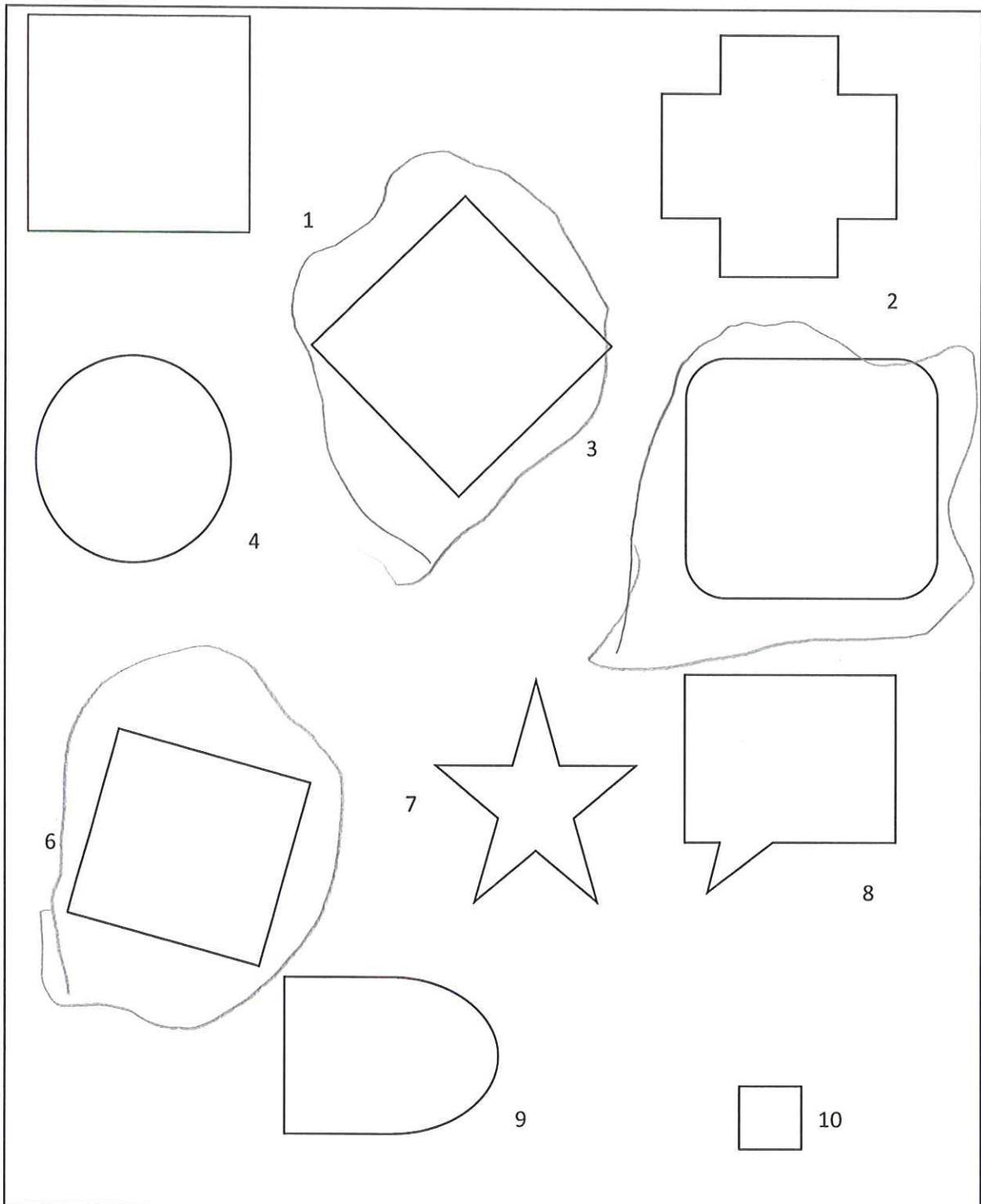

5

- ENCERCLA ELS RECTANGLES

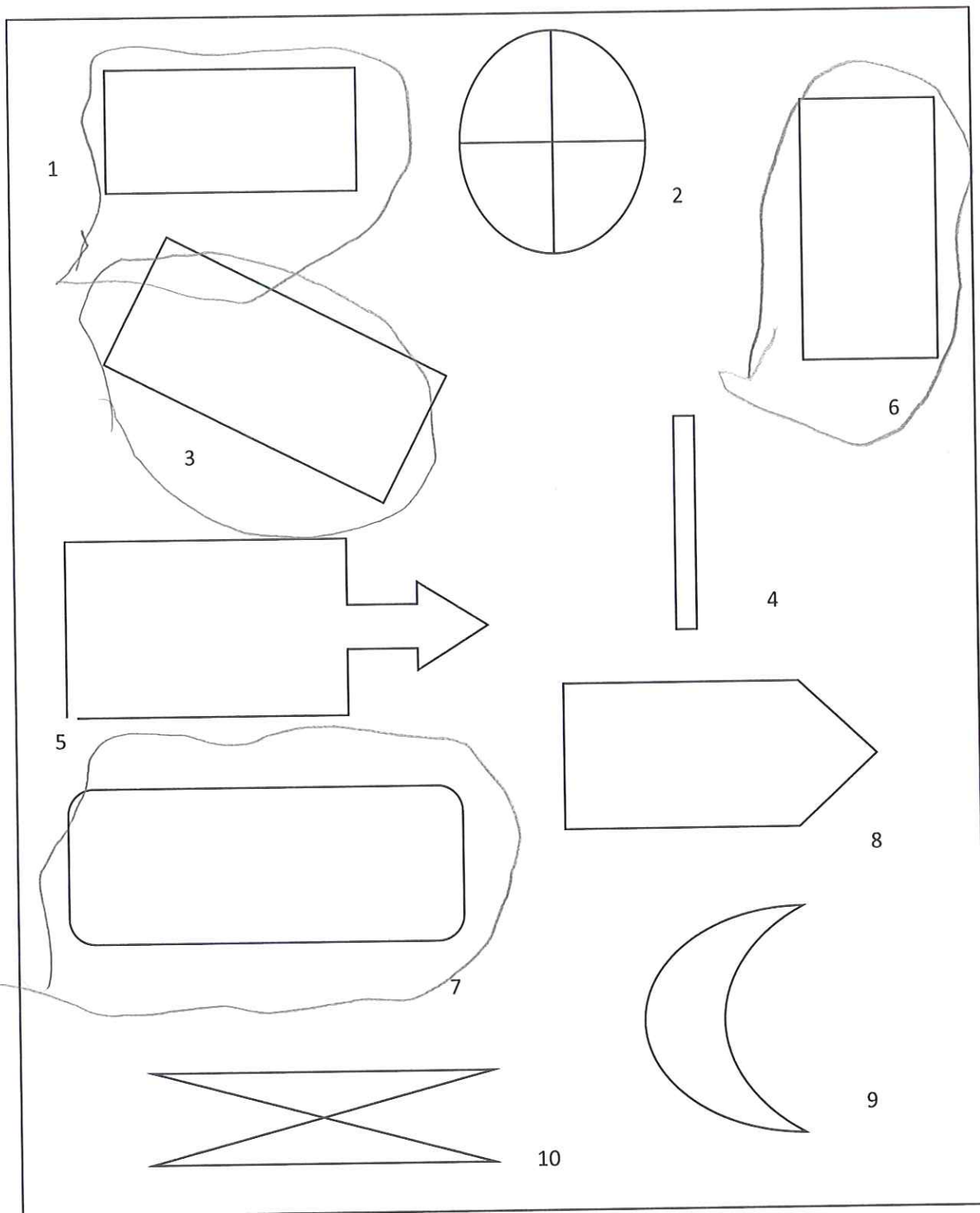

• ENCERCLA ELS TRIANGLES

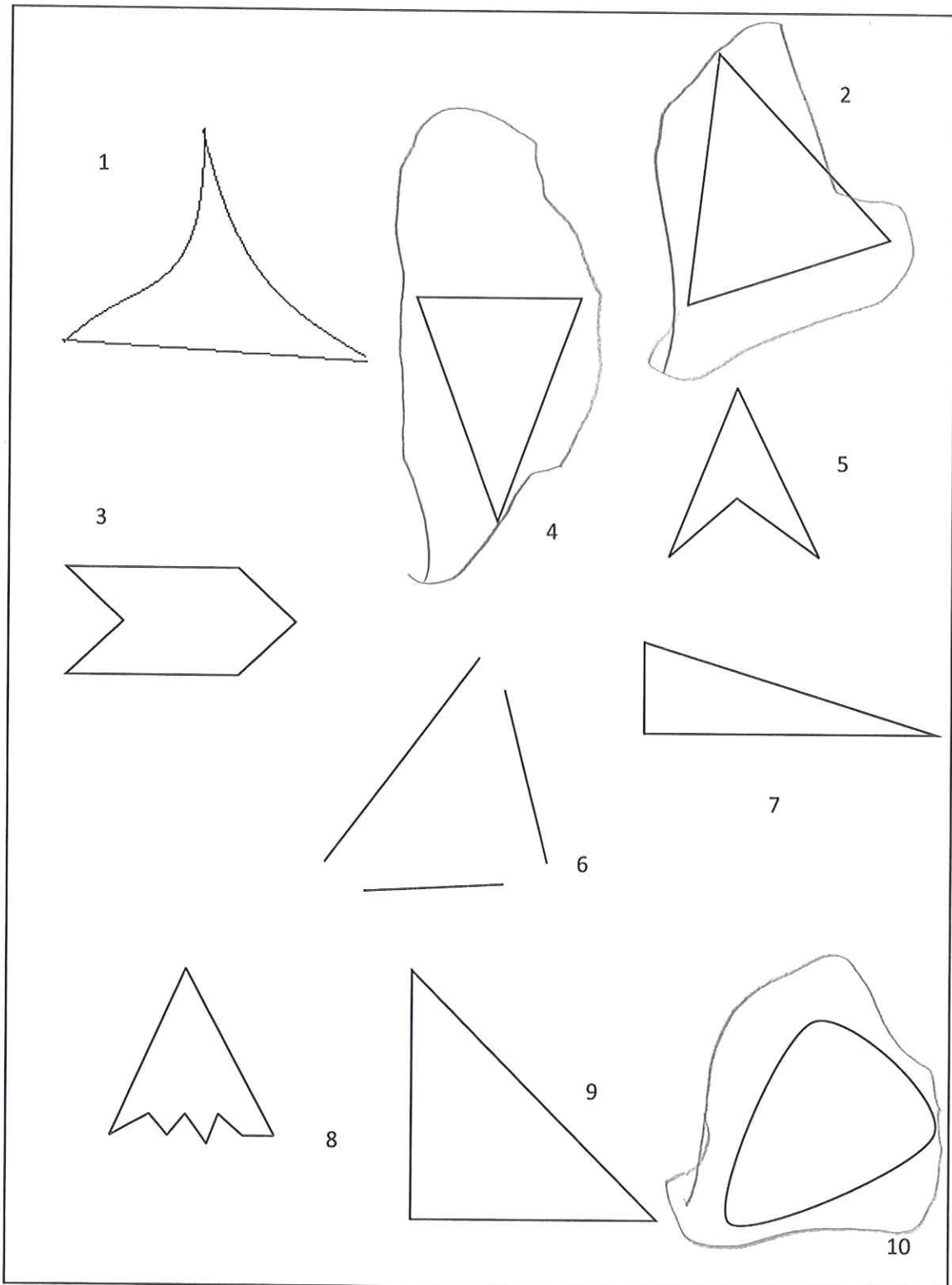

TEST PELS INFANTS DE P4B

1. DIBUIXA UN QUADRAT

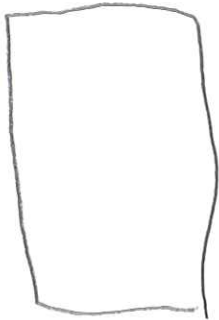

2. DIBUIXA UN RECTANGLE



3. DIBUIXA UN TRIANGLE

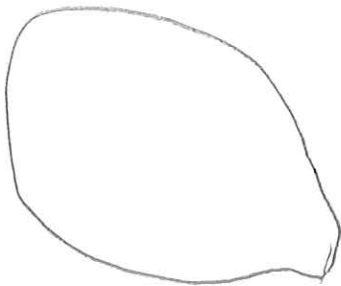

4. DIBUIXA UN CERCLE

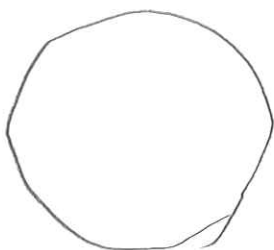

5. QUANTS COSTATS TENEN AQUESTES FIGURES GEOMÈTRIQUES I VÈRTEXS



Costats

Vèrtexs

1

4

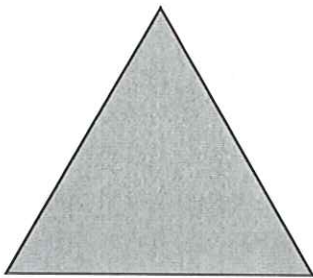

3

3



0

4



4

4

6. IDENTIFICA I ENCERCLA LES FIGURES GEOMÈTRIQUES.

- ENCERCLA ELS CERCLES

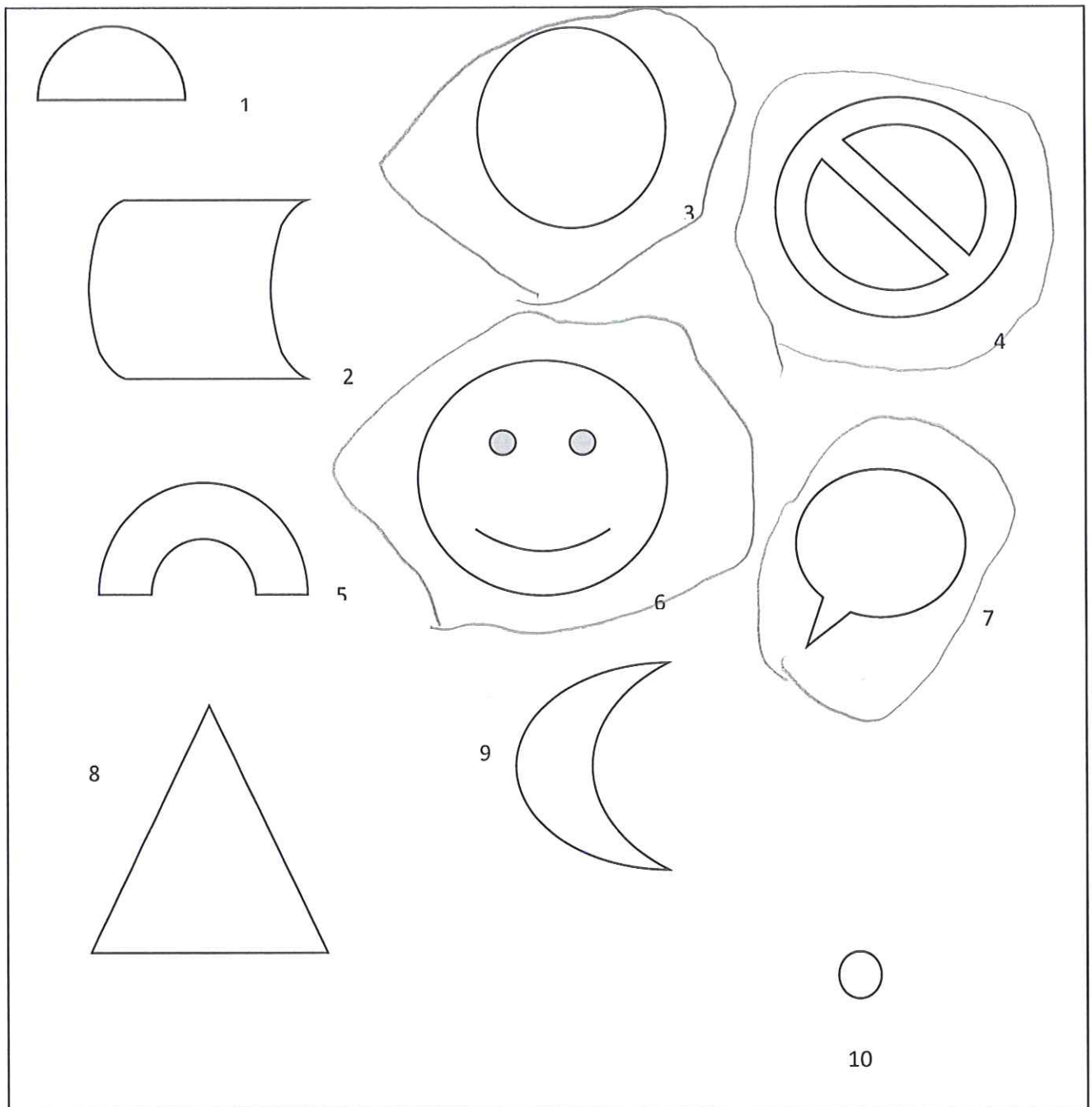

• ENCERCLA ELS QUADRATS

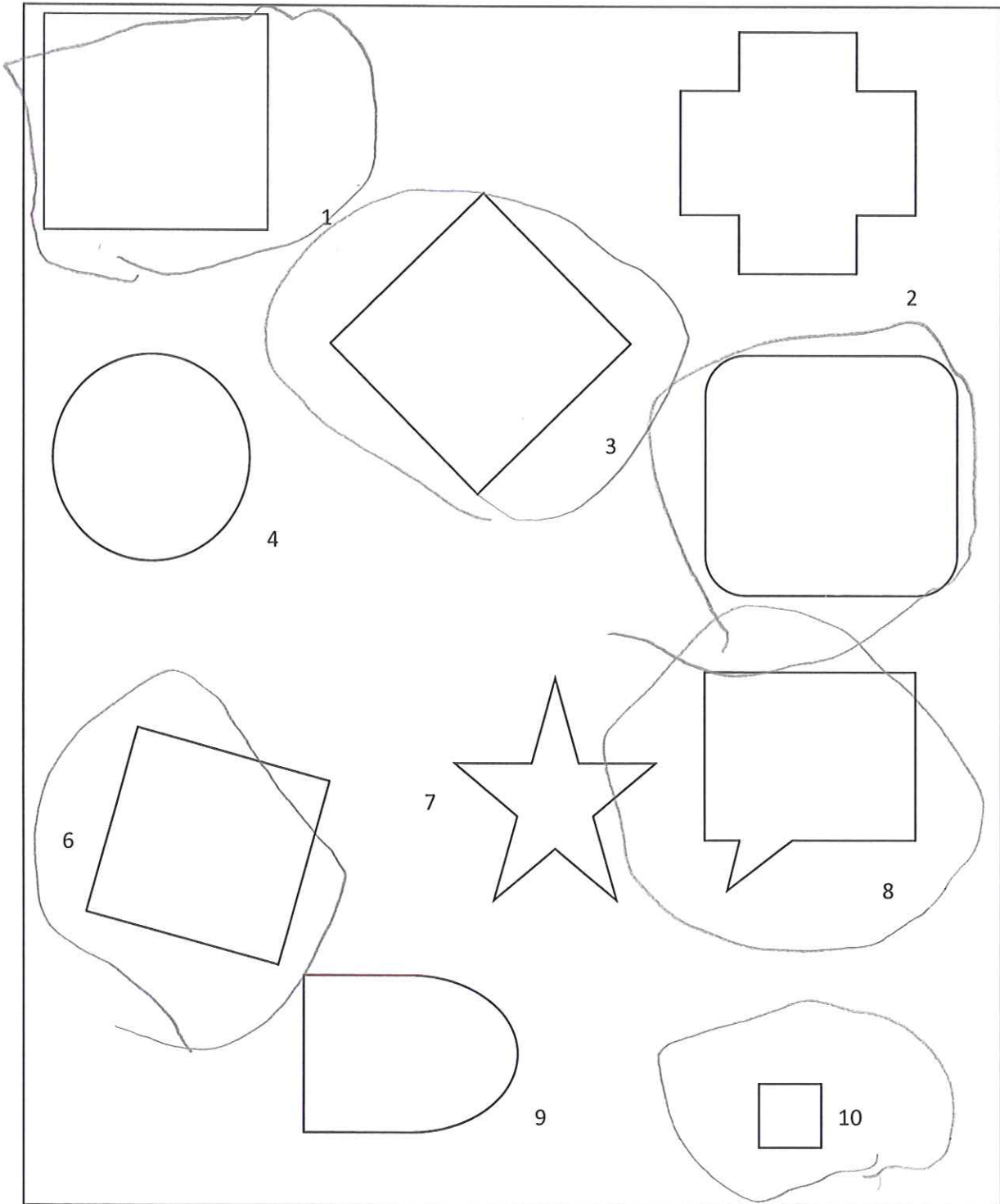

• ENCERCLA ELS RECTANGLES

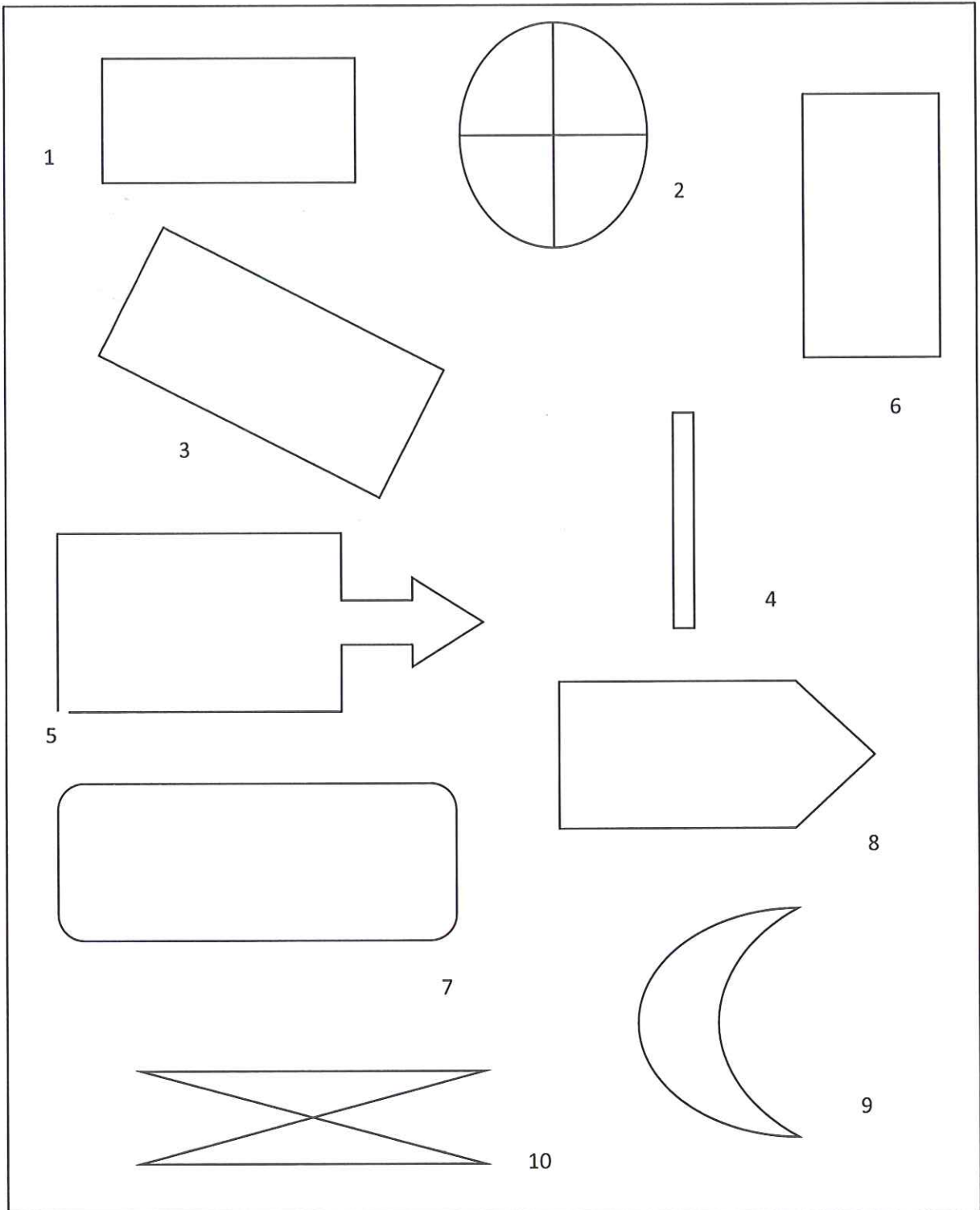

• ENCERCLA ELS TRIANGLES

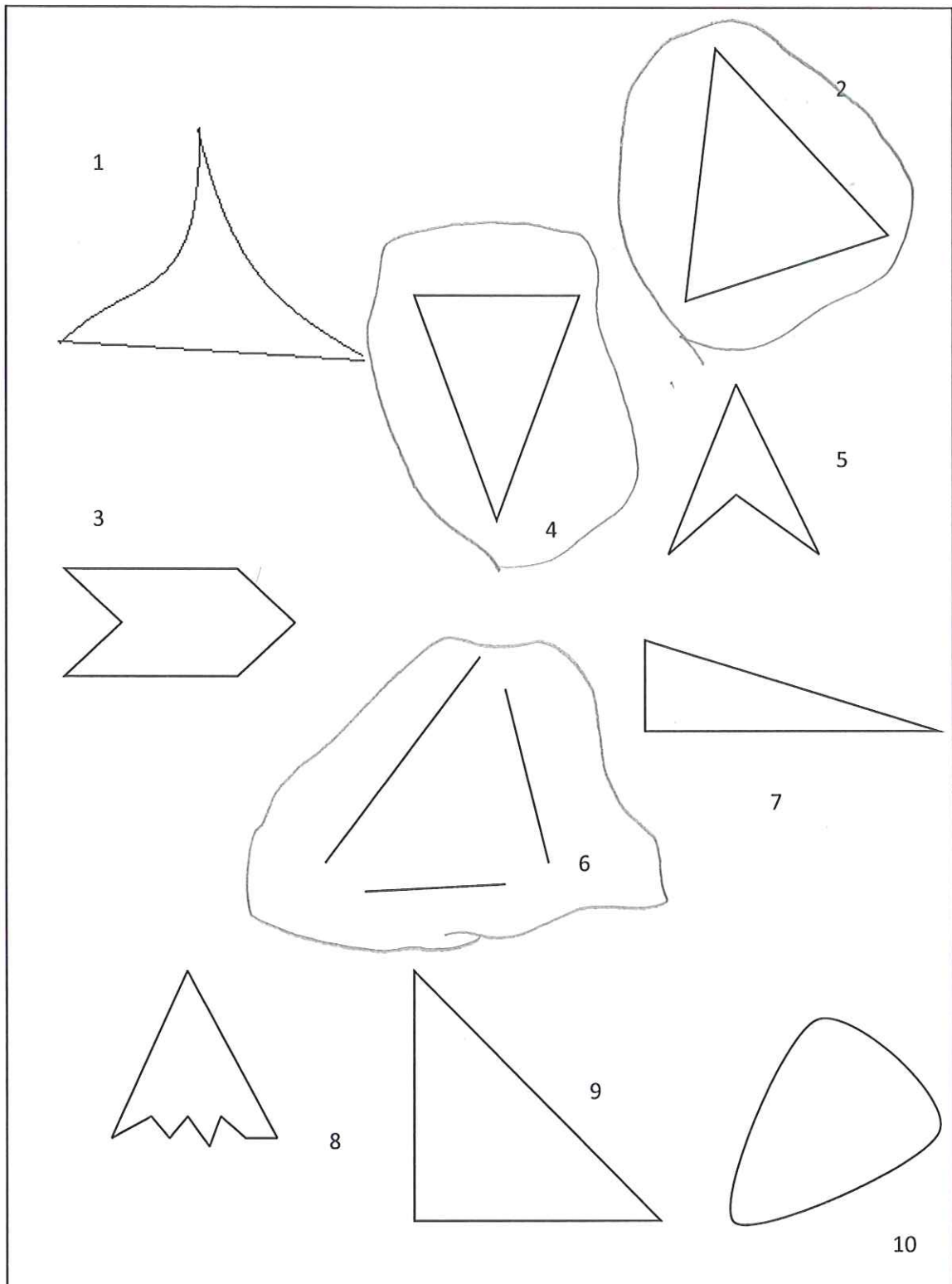

TEST PELS INFANTS DE P4B

1. DIBUIXA UN QUADRAT



2. DIBUIXA UN RECTANGLE



3. DIBUIXA UN TRIANGLE



4. DIBUIXA UN CERCLE



5. QUANTS COSTATS TENEN AQUESTES FIGURES GEOMÈTRIQVES I VÈRTEXS



Costats

Vèrtexs

4

4

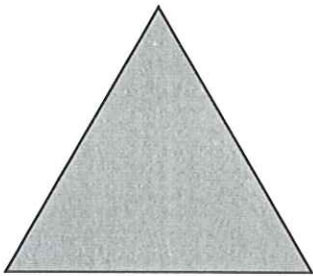

4

4



705

0



4

4

6. IDENTIFICA I ENCERCLA LES FIGURES GEOMÈTRIQUES.

- ENCERCLA ELS CERCLES

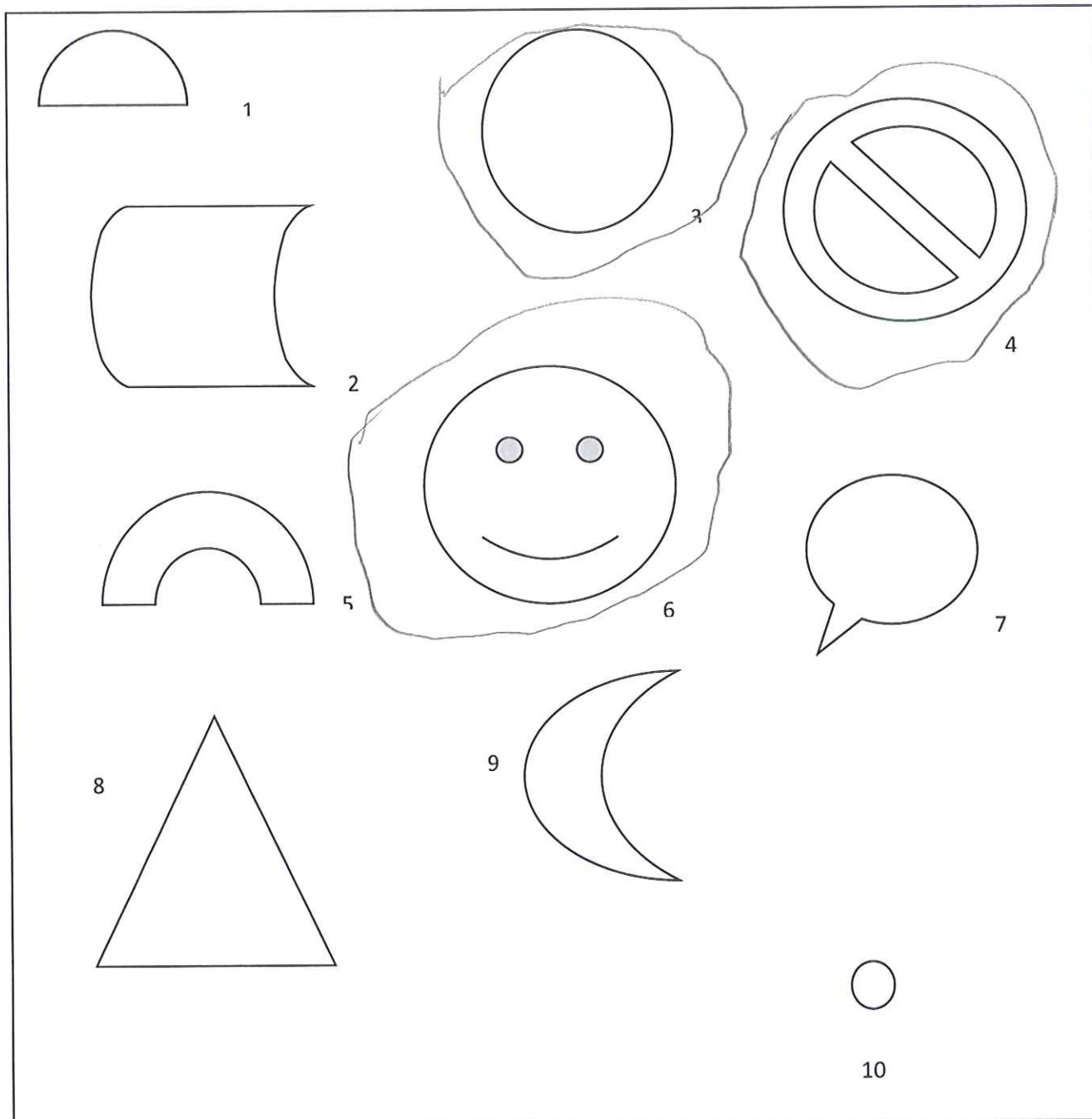

• ENCERCLA ELS QUADRATS

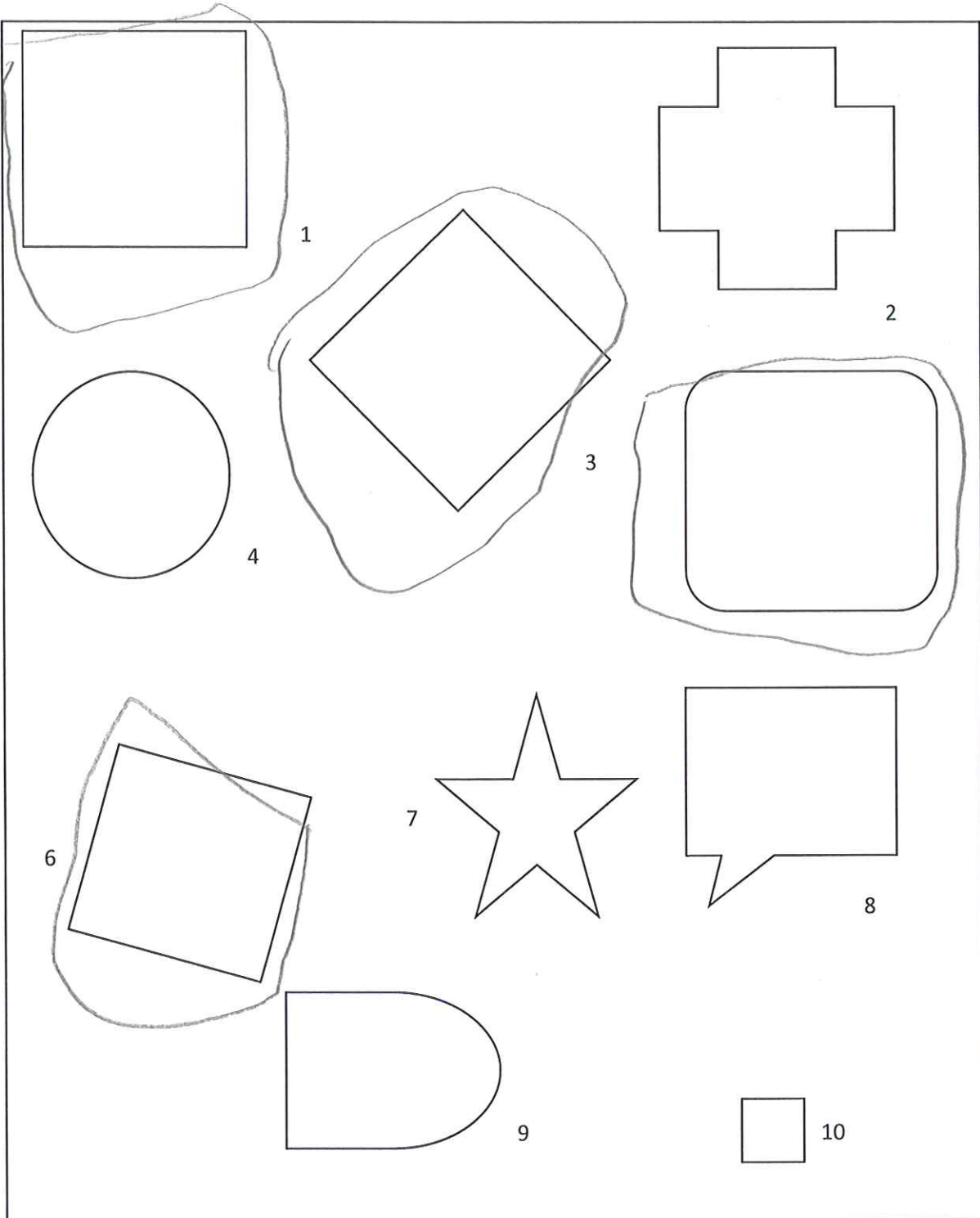

- ENCERCLA ELS RECTANGLES

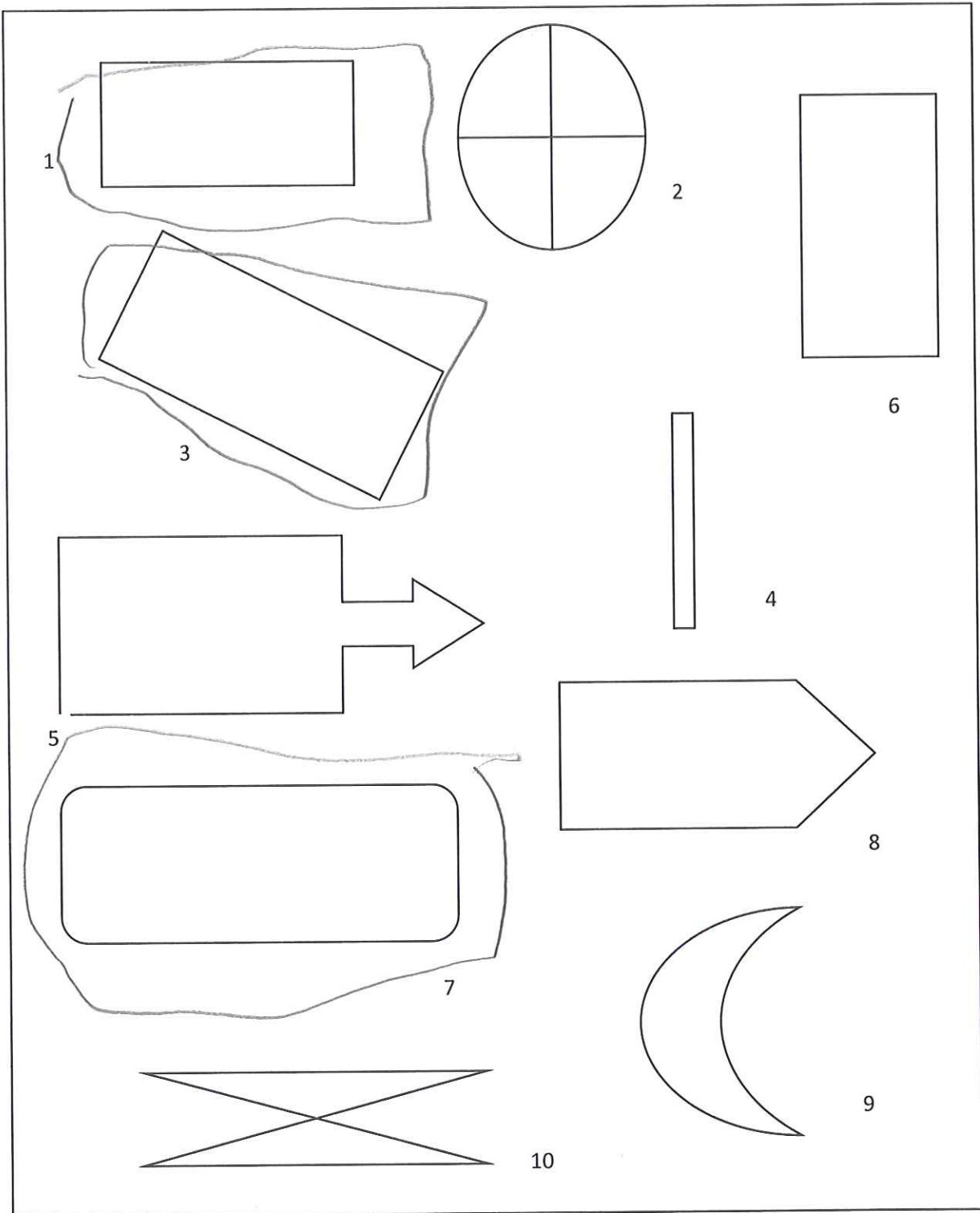

• ENCERCLA ELS TRIANGLES

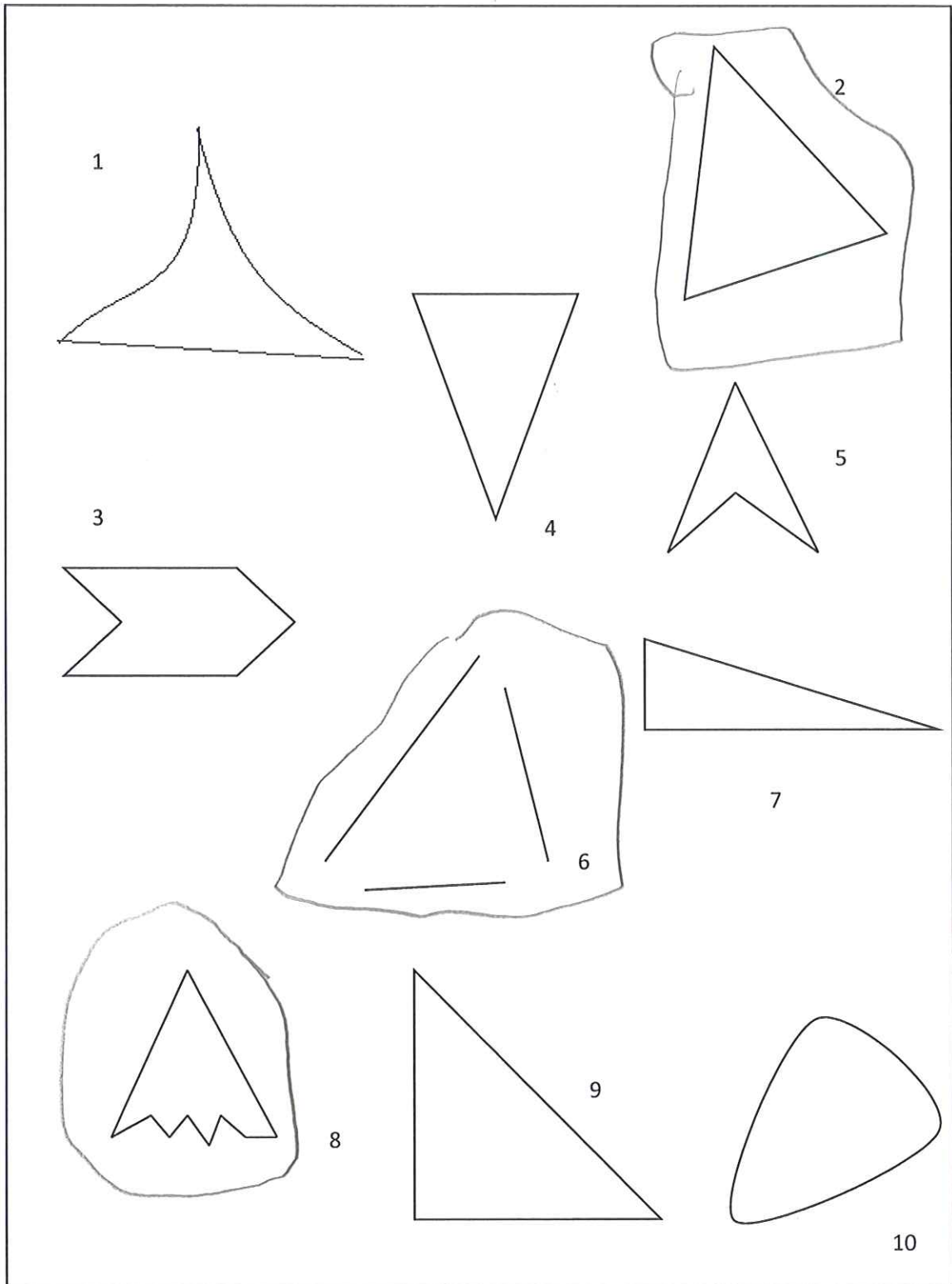

TEST PELS INFANTS DE P4B

1. DIBUIXA UN QUADRAT



2. DIBUIXA UN RECTANGLE



3. DIBUIXA UN TRIANGLE



4. DIBUIXA UN CERCLE



5. QUANTS COSTATS TENEN AQUESTES FIGURES GEOMÈTRIQUES I VÈRTEXS



Costat

Vèrtexs

1

1

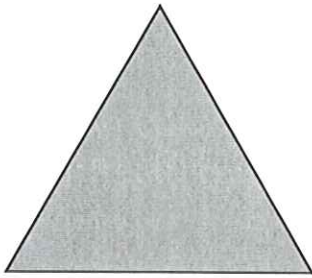

2

2



4

1



5

6

6. IDENTIFICA I ENCERCLA LES FIGURES GEOMÈTRIQUES.

- ENCERCLA ELS CERCLES

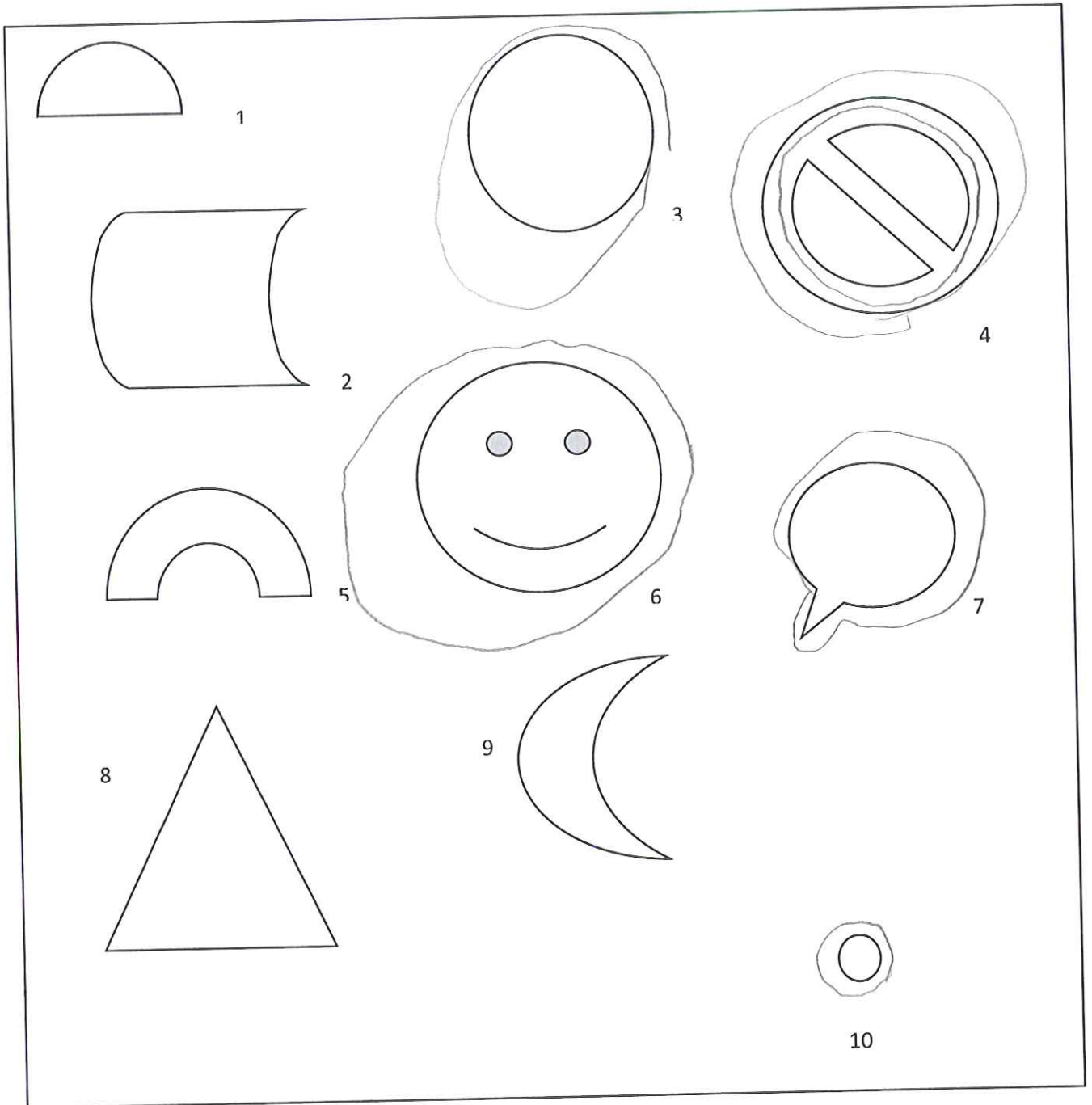

• ENCERCLA ELS QUADRATS

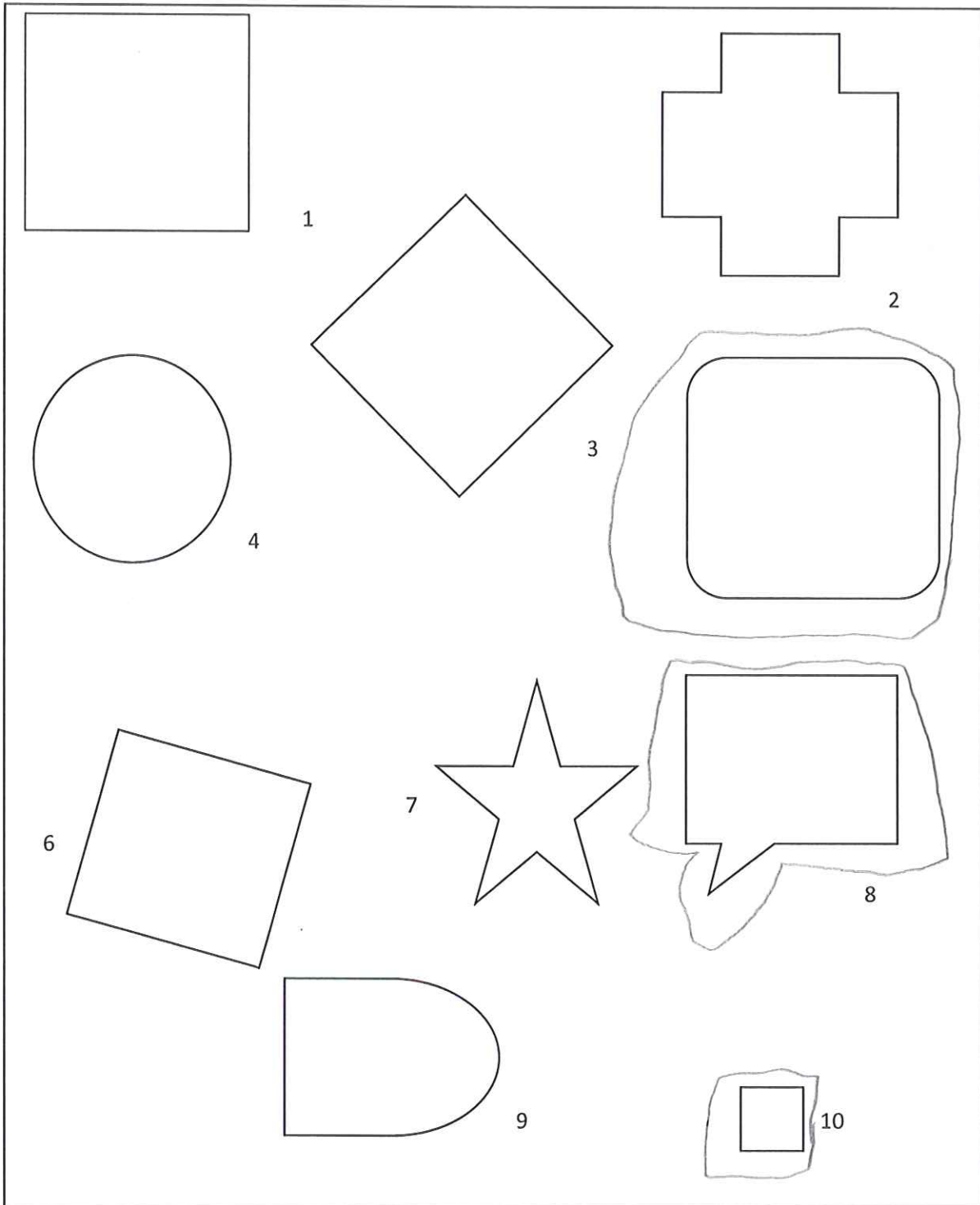

5

- ENCERCLA ELS RECTANGLES

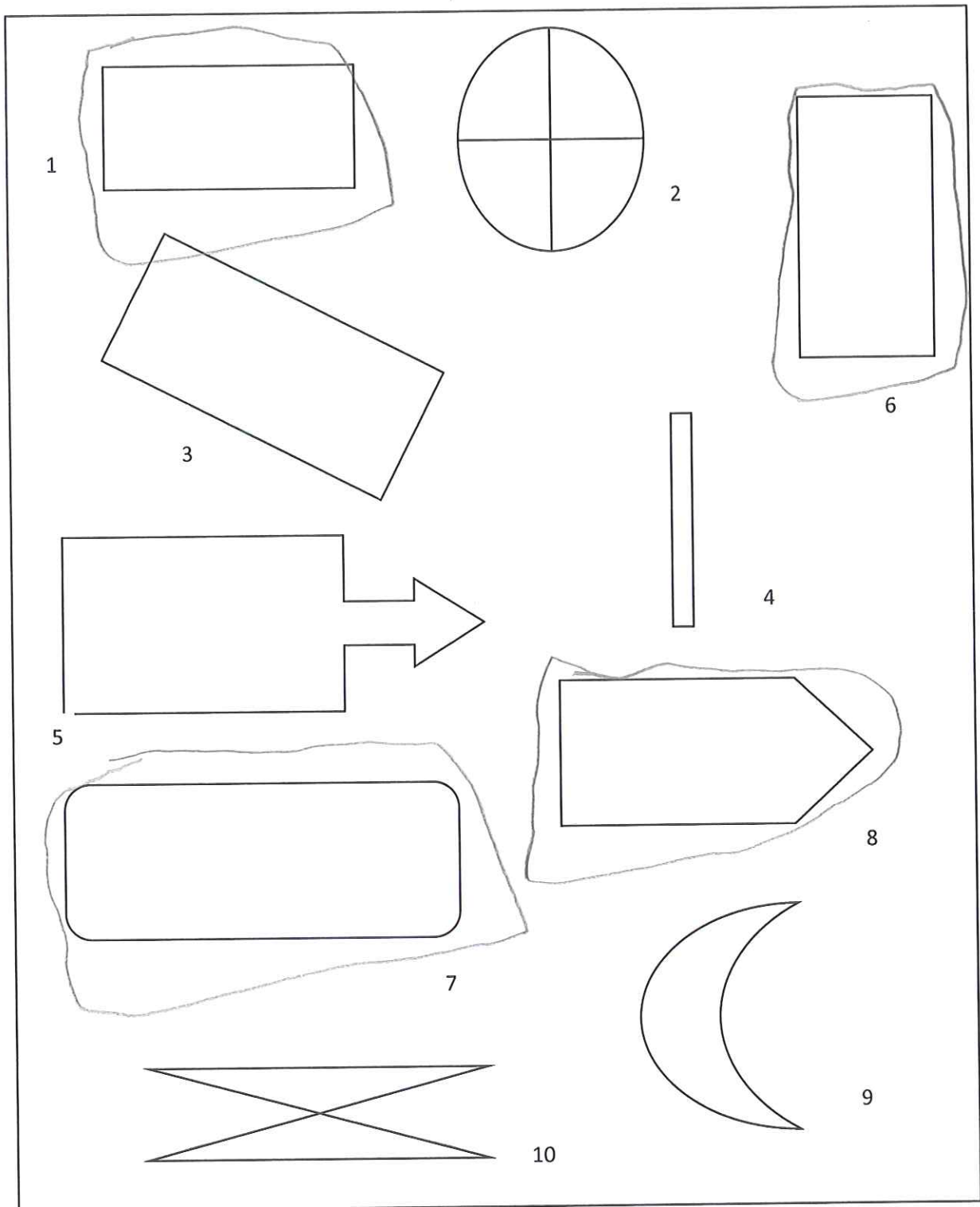

• ENCERCLA ELS TRIANGLES

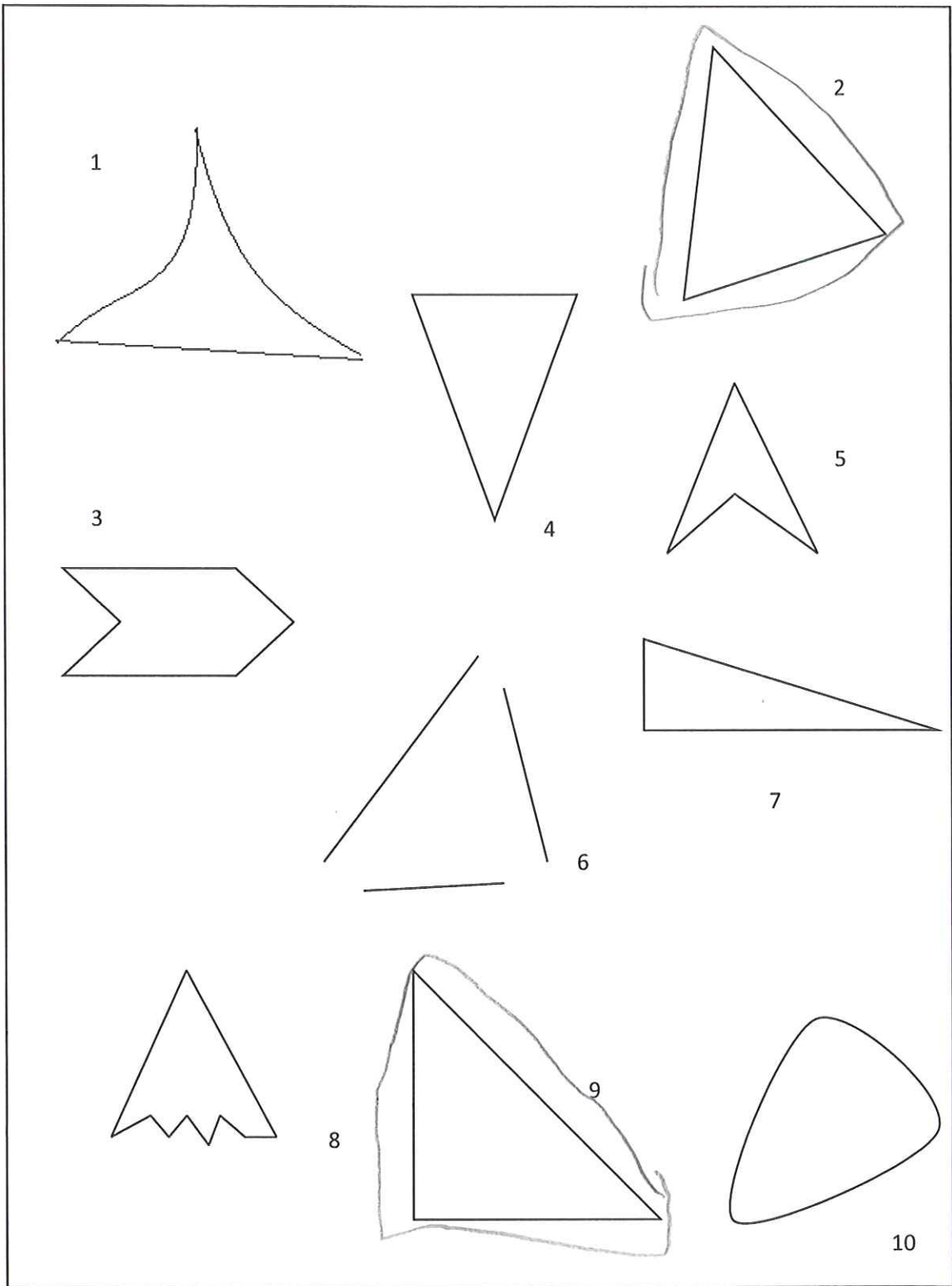

TEST PELS INFANTS DE P4B

1. DIBUIXA UN QUADRAT



2. DIBUIXA UN RECTANGLE



3. DIBUIXA UN TRIANGLE

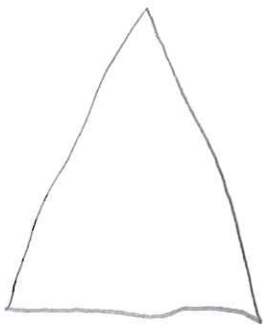

4. DIBUIXA UN CERCLE



5. QUANTS COSTATS TENEN AQUESTES FIGURES GEOMÈTRIQUES I VÈRTEXS



Costats

Vèrtexs

3

4

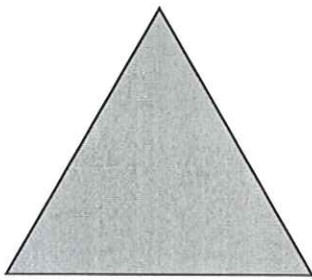

1

5



2

5

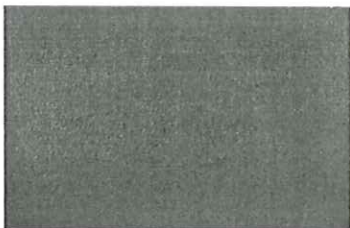

2

5

6. IDENTIFICA I ENCERCLA LES FIGURES GEOMÈTRIQUES.

- ENCERCLA ELS CERCLES

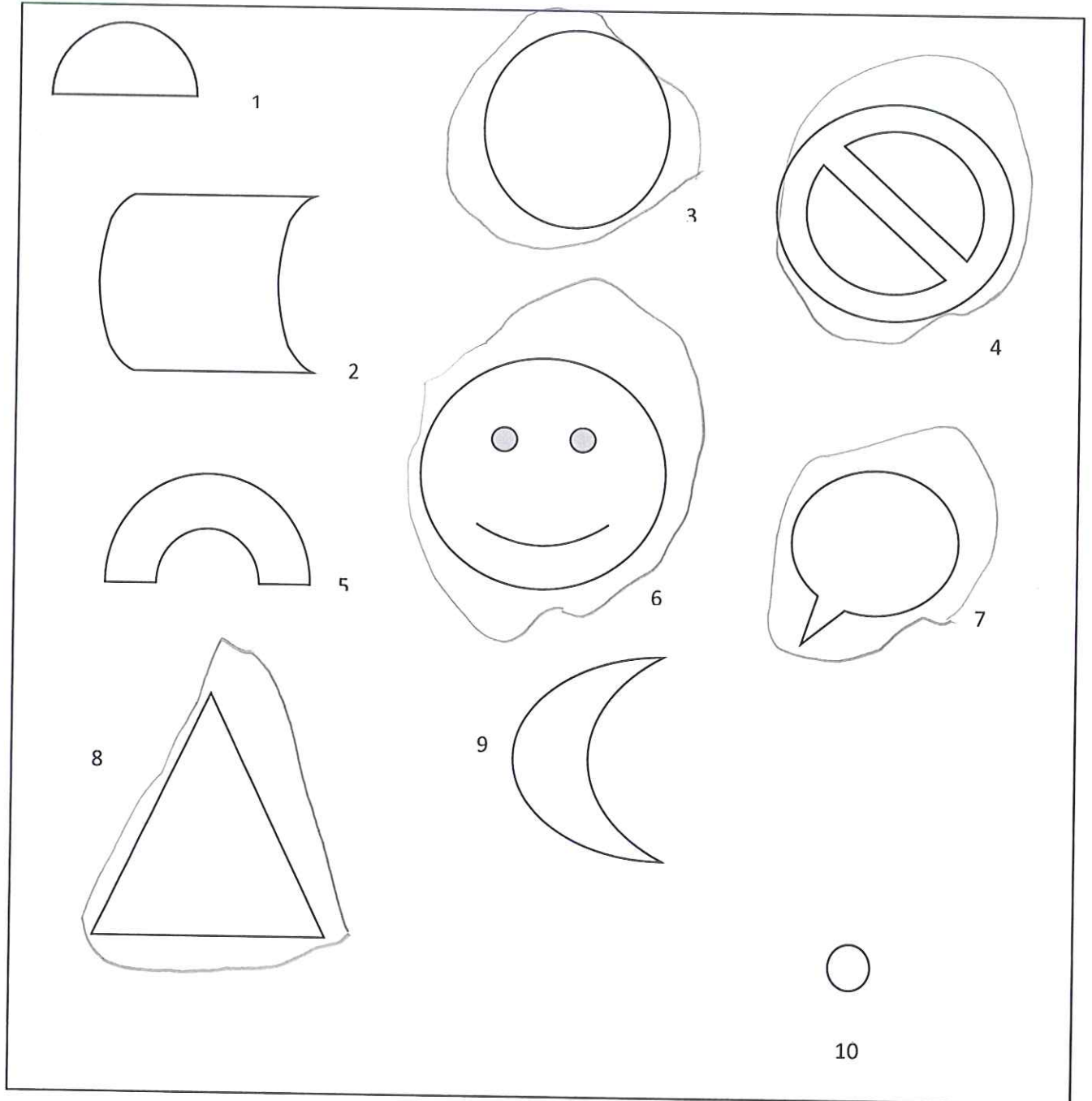

• ENCERCLA ELS QUADRATS

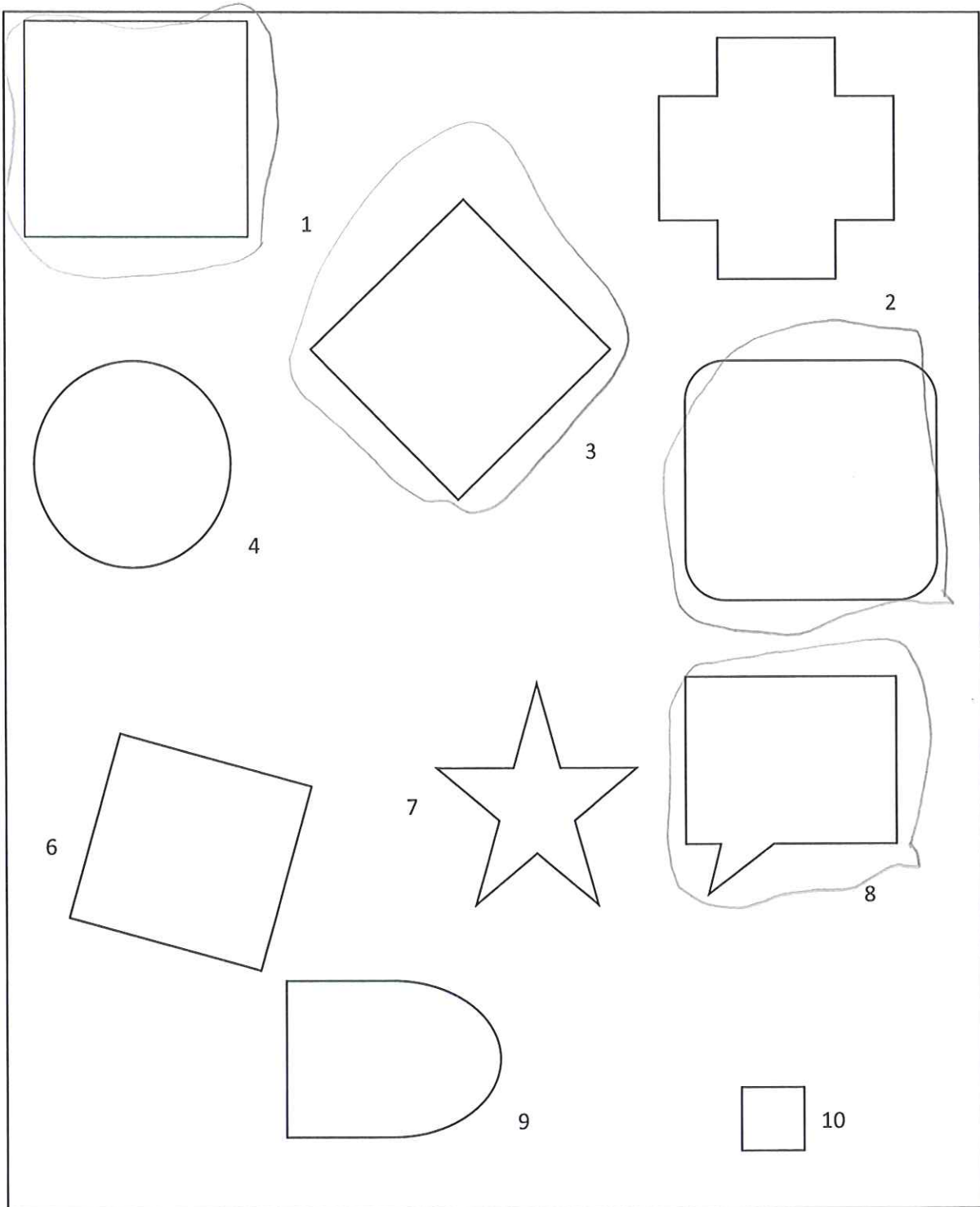

- ENCERCLA ELS RECTANGLES

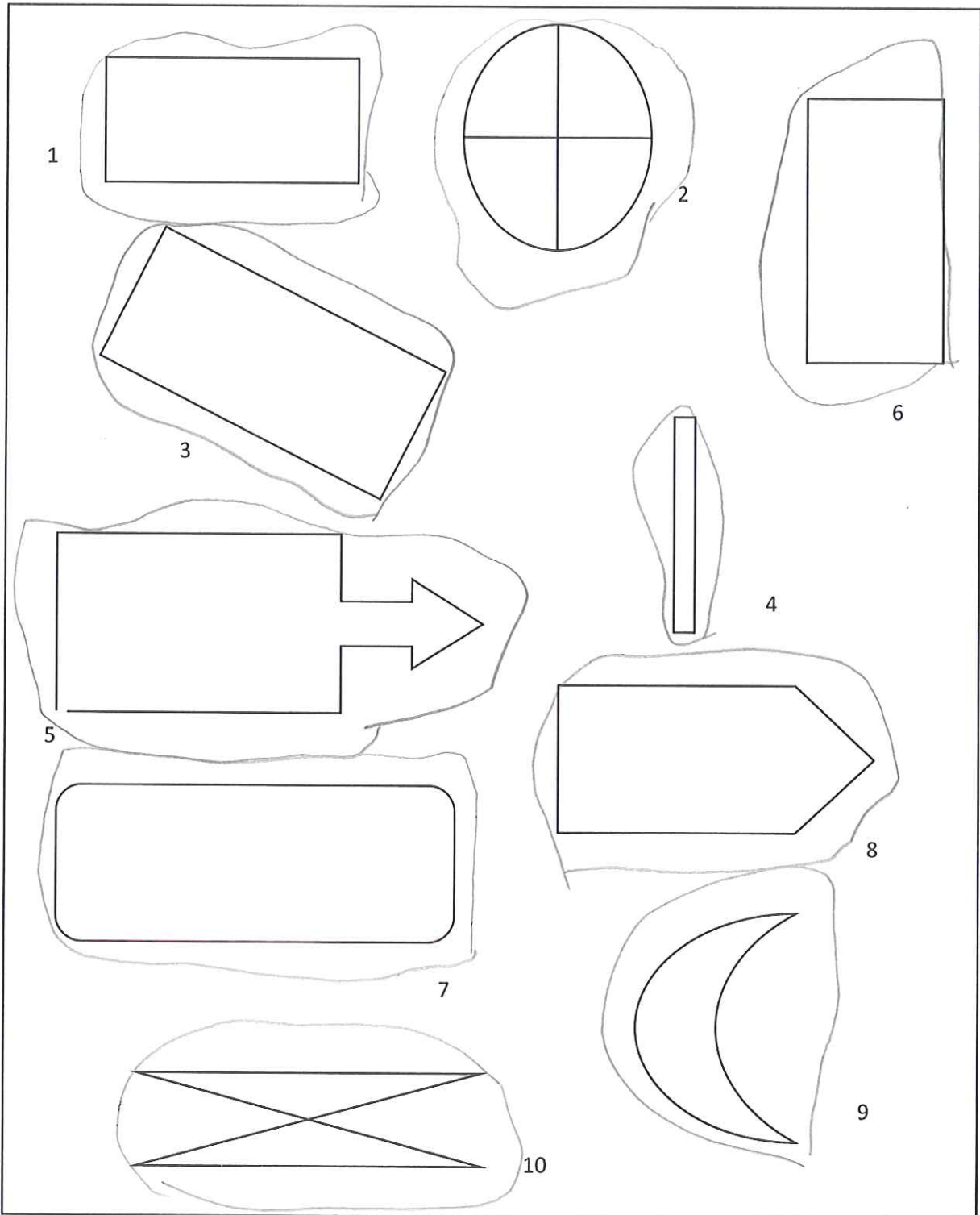

• ENCERCLA ELS TRIANGLES

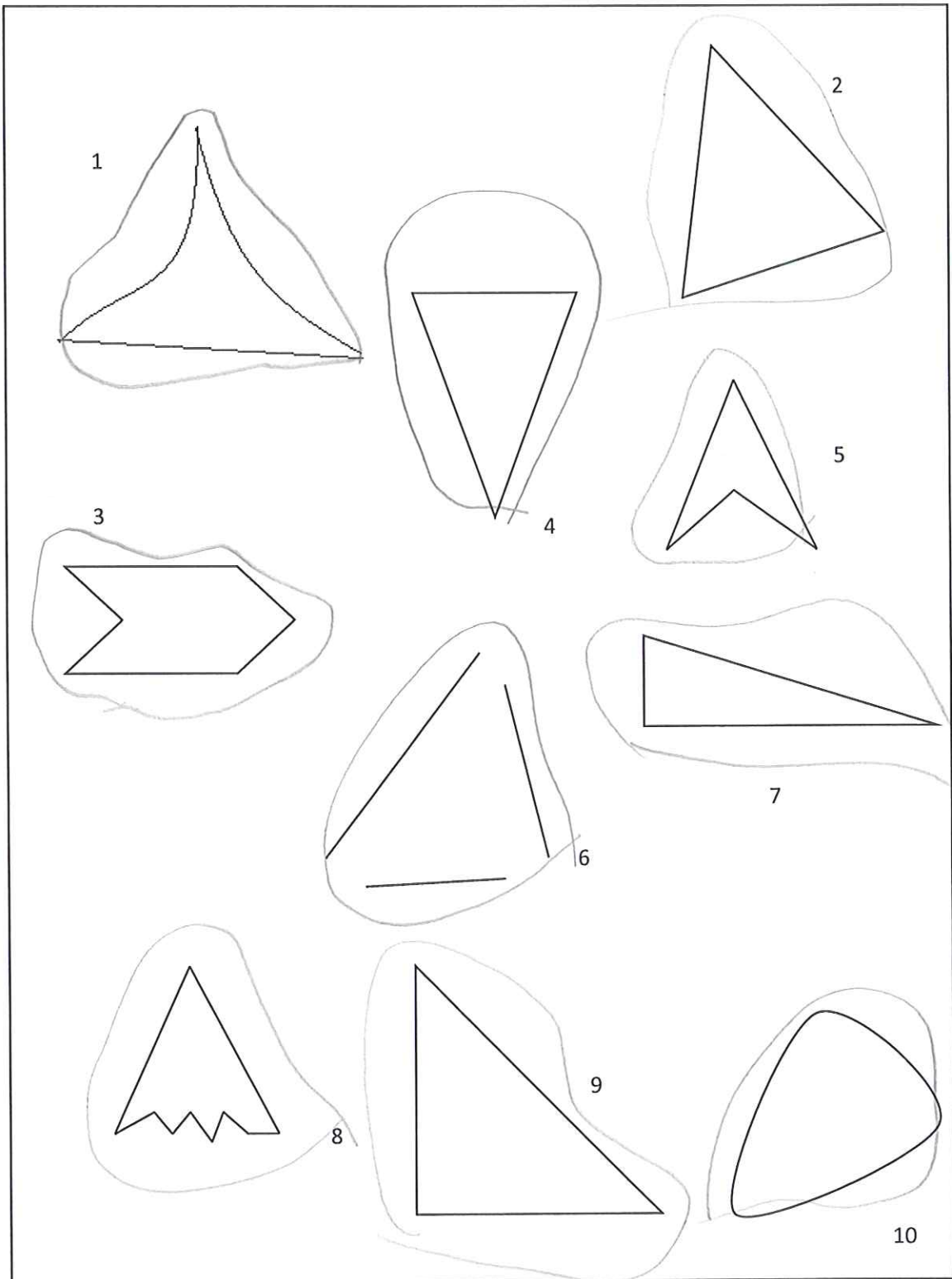

TEST PELS INFANTS DE P4B

1. DIBUIXA UN QUADRAT

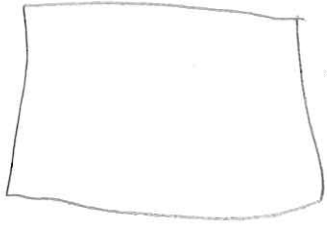

2. DIBUIXA UN RECTANGLE

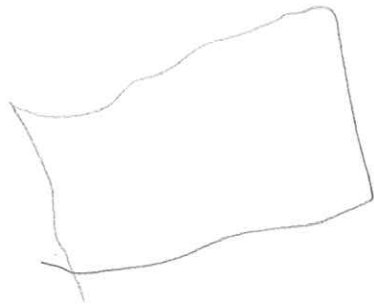

3. DIBUIXA UN TRIANGLE

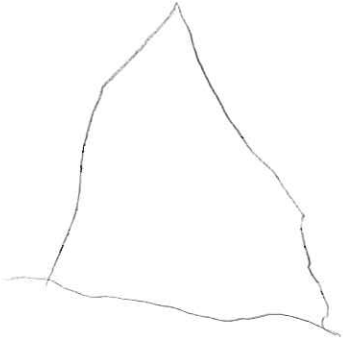

4. DIBUIXA UN CERCLE



5. QUANTS COSTATS TENEN AQUESTES FIGURES GEOMÈTRIQUES I VÈRTEXS



Costats

Vèrtexs

2

4

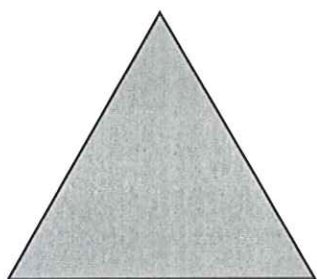

2

4



1

4



4

4

6. IDENTIFICA I ENCERCLA LES FIGURES GEOMÈTRIQUES.

- ENCERCLA ELS CERCLES

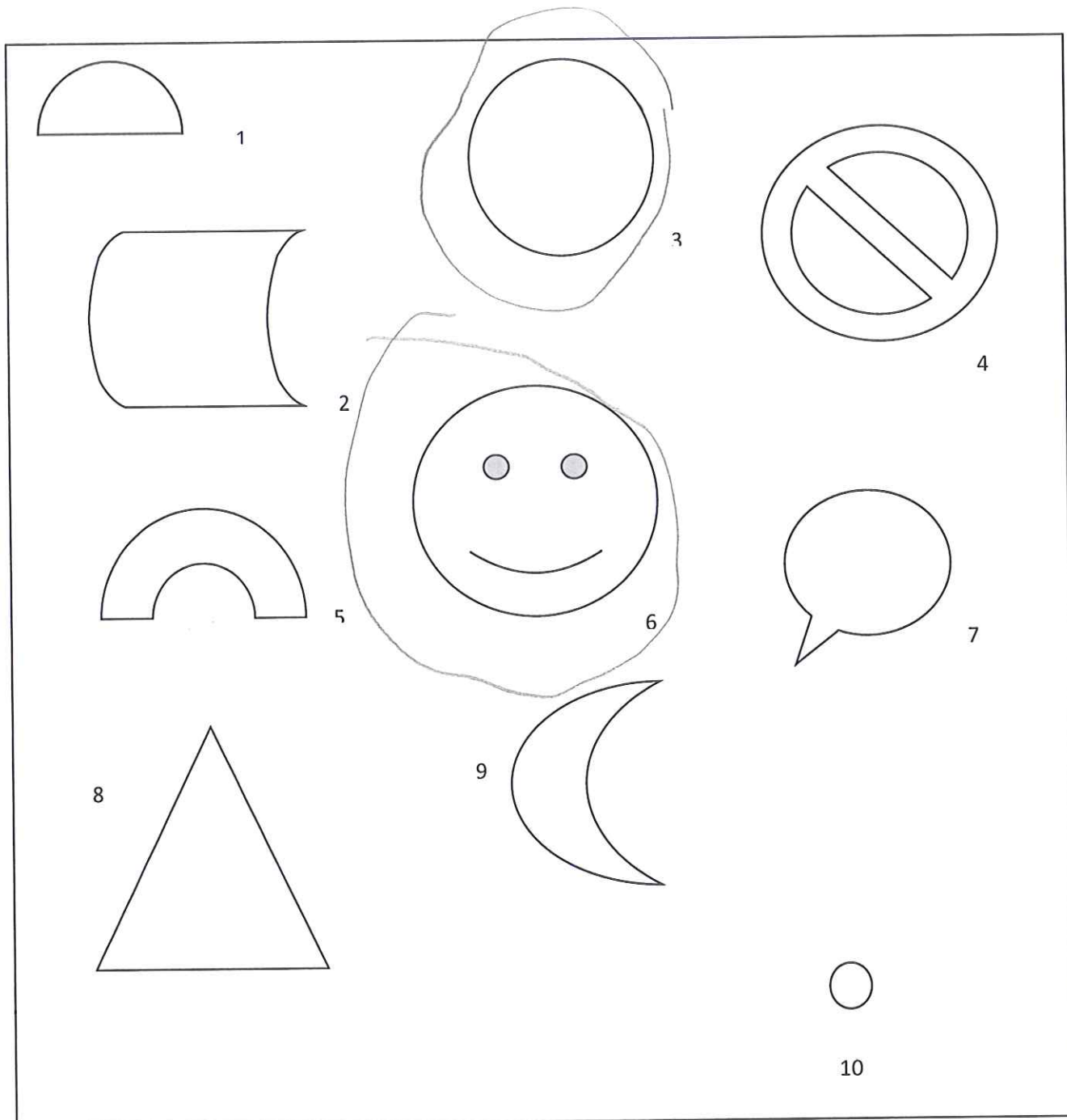

• ENCERCLA ELS QUADRATS

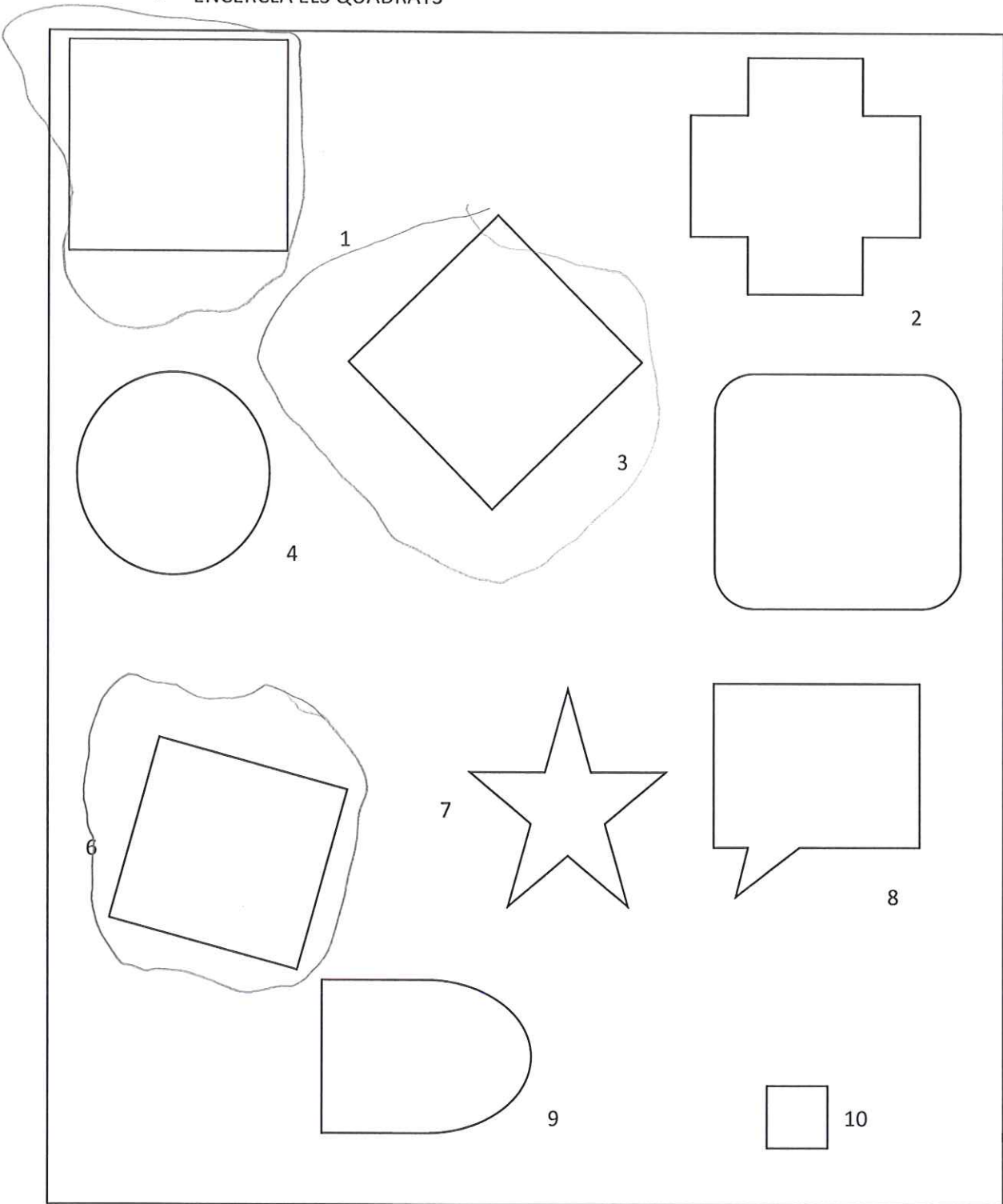

- ENCERCLA ELS RECTANGLES

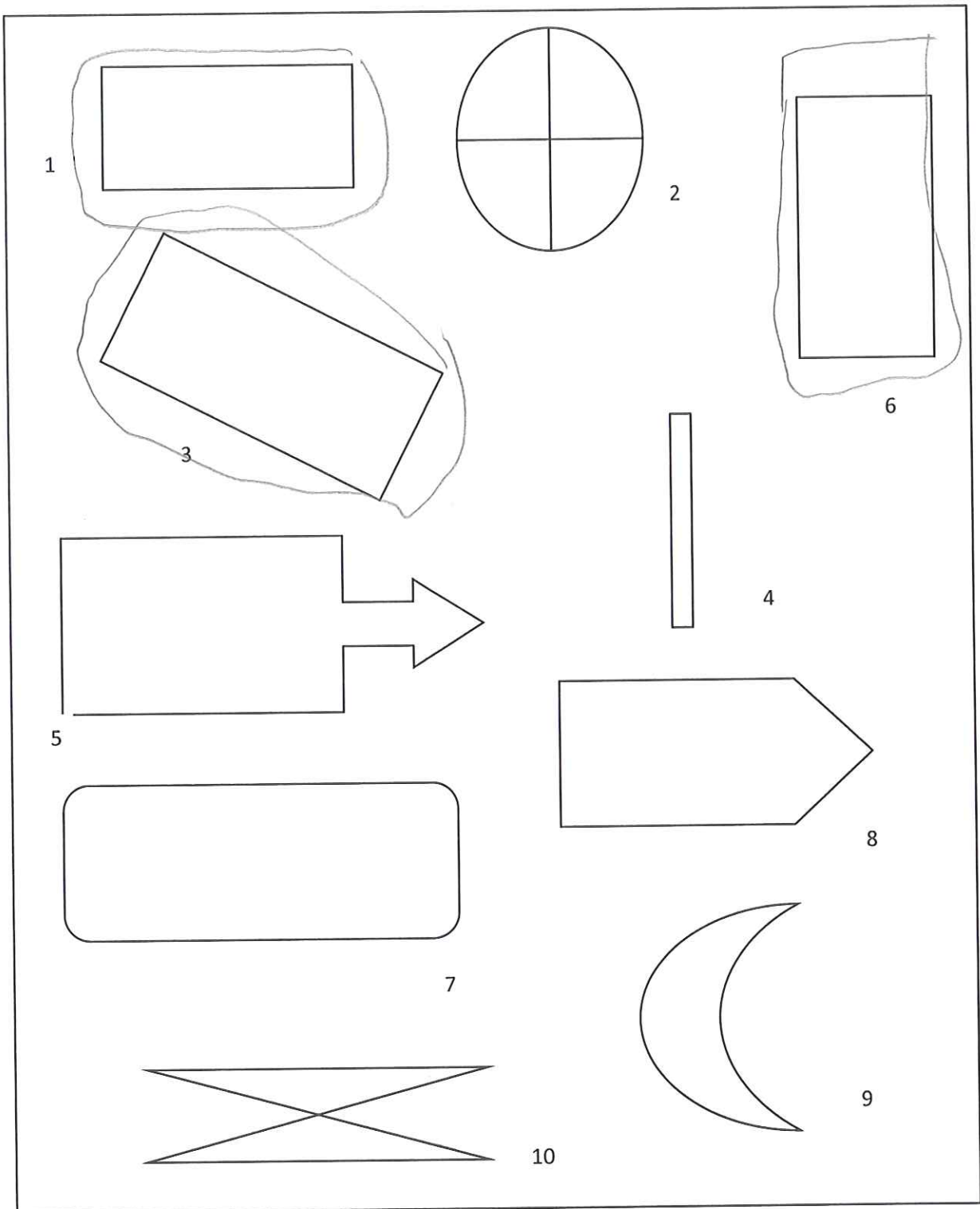

• ENCERCLA ELS TRIANGLES

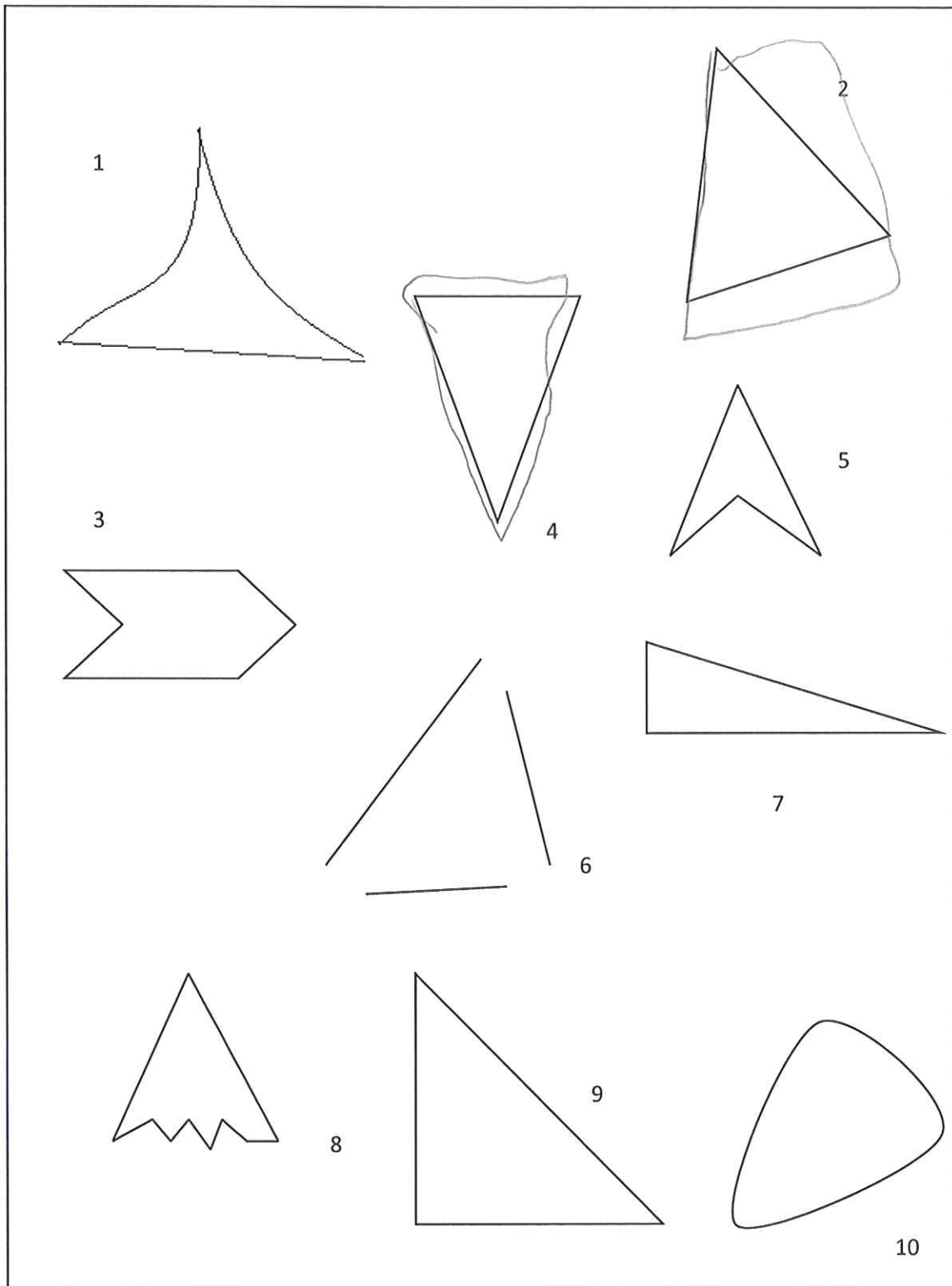

TEST PELS INFANTS DE P4B

1. DIBUIXA UN QUADRAT

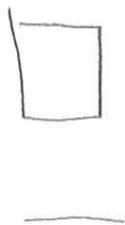

2. DIBUIXA UN RECTANGLE



3. DIBUIXA UN TRIANGLE



4. DIBUIXA UN CERCLE



5. QUANTS COSTATS TENEN AQUESTES FIGURES GEOMÈTRIQUES I VÈRTEXS

Costats

Vèrtexs



4

4

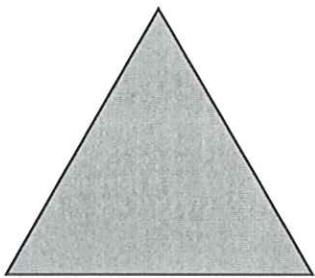

3

3



0

0



4

4

6. IDENTIFICA I ENCERCLA LES FIGURES GEOMÈTRIQUES.

- ENCERCLA ELS CERCLES

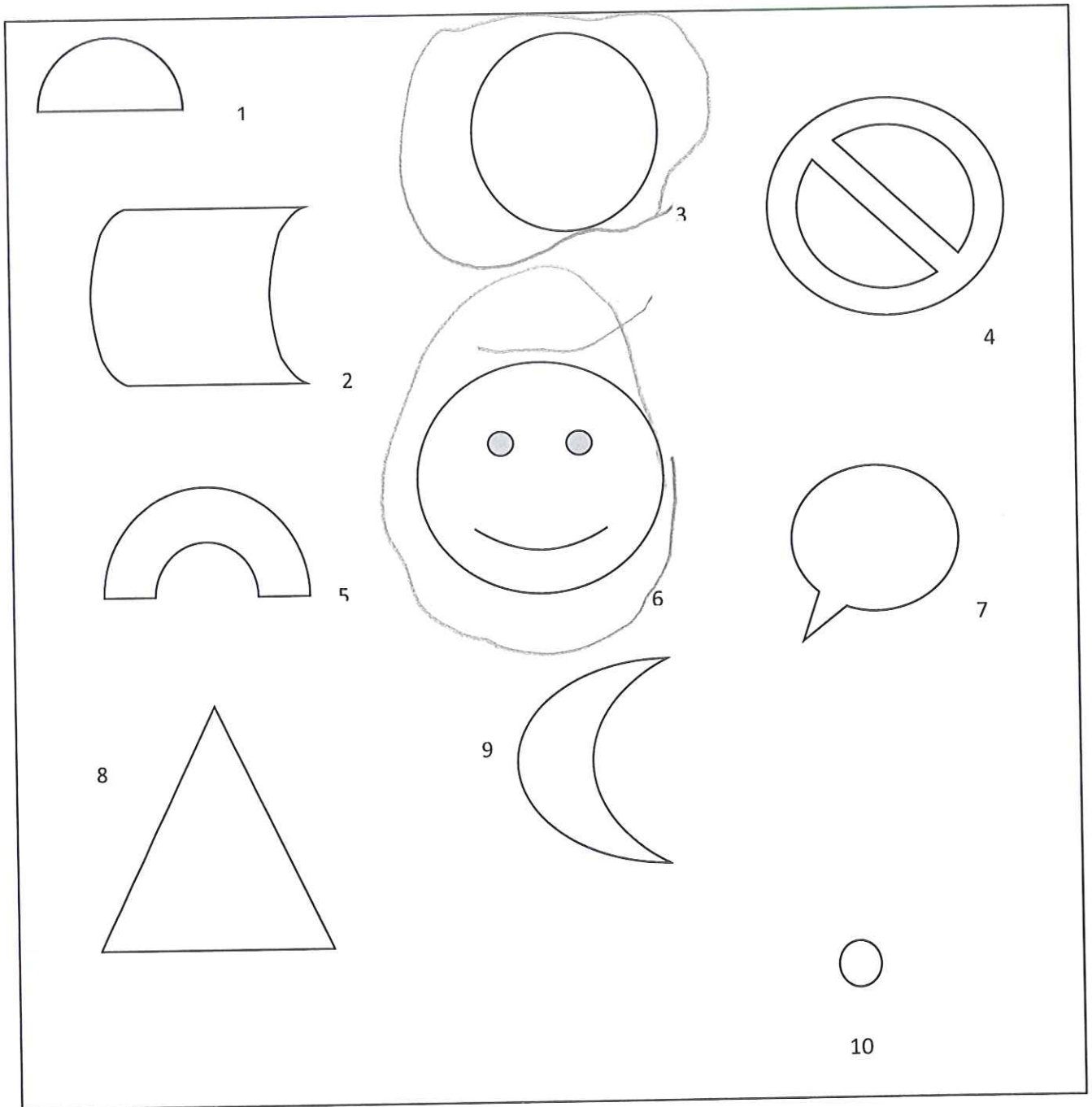

• ENCERCLA ELS QUADRATS

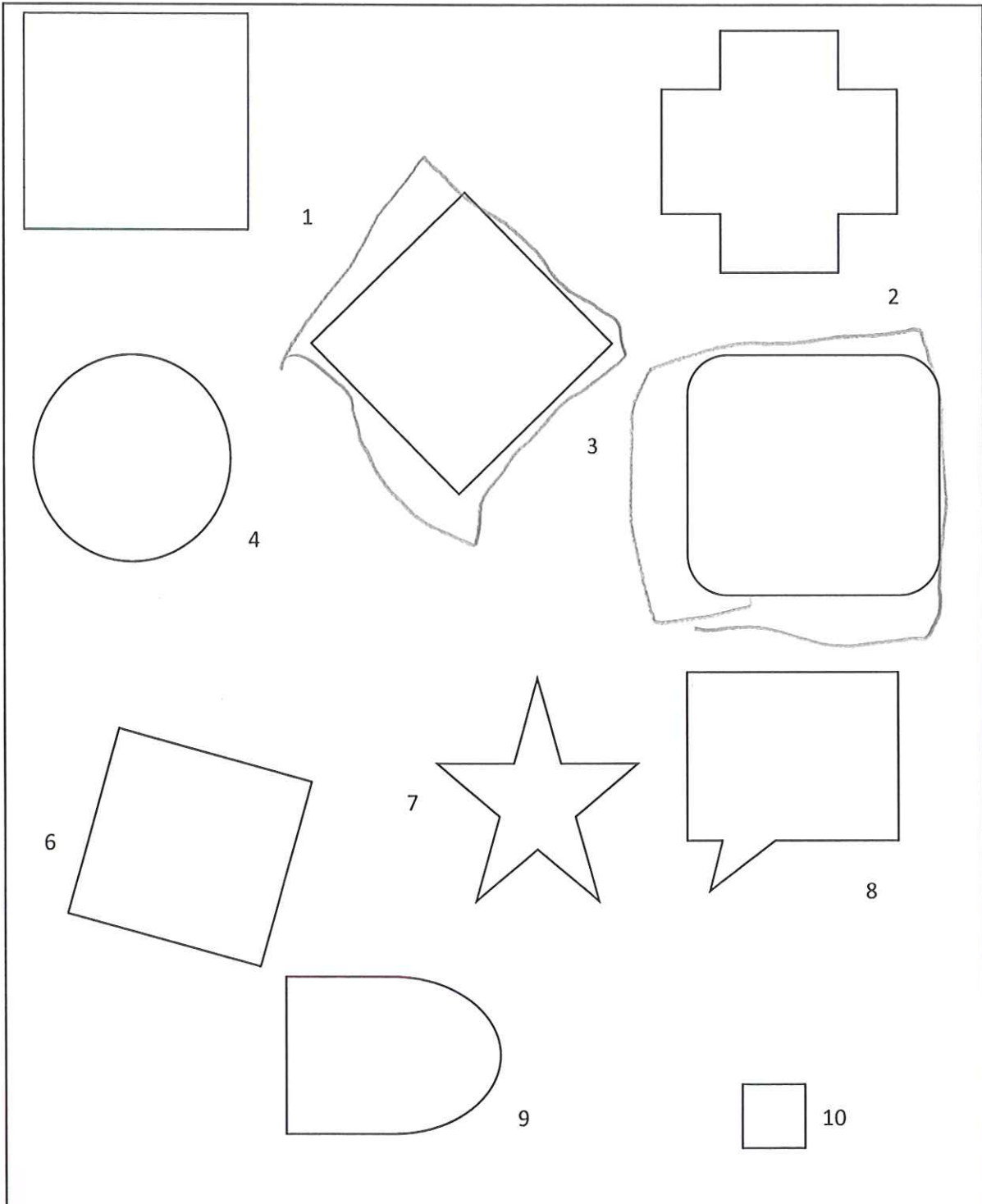

- ENCERCLA ELS RECTANGLES

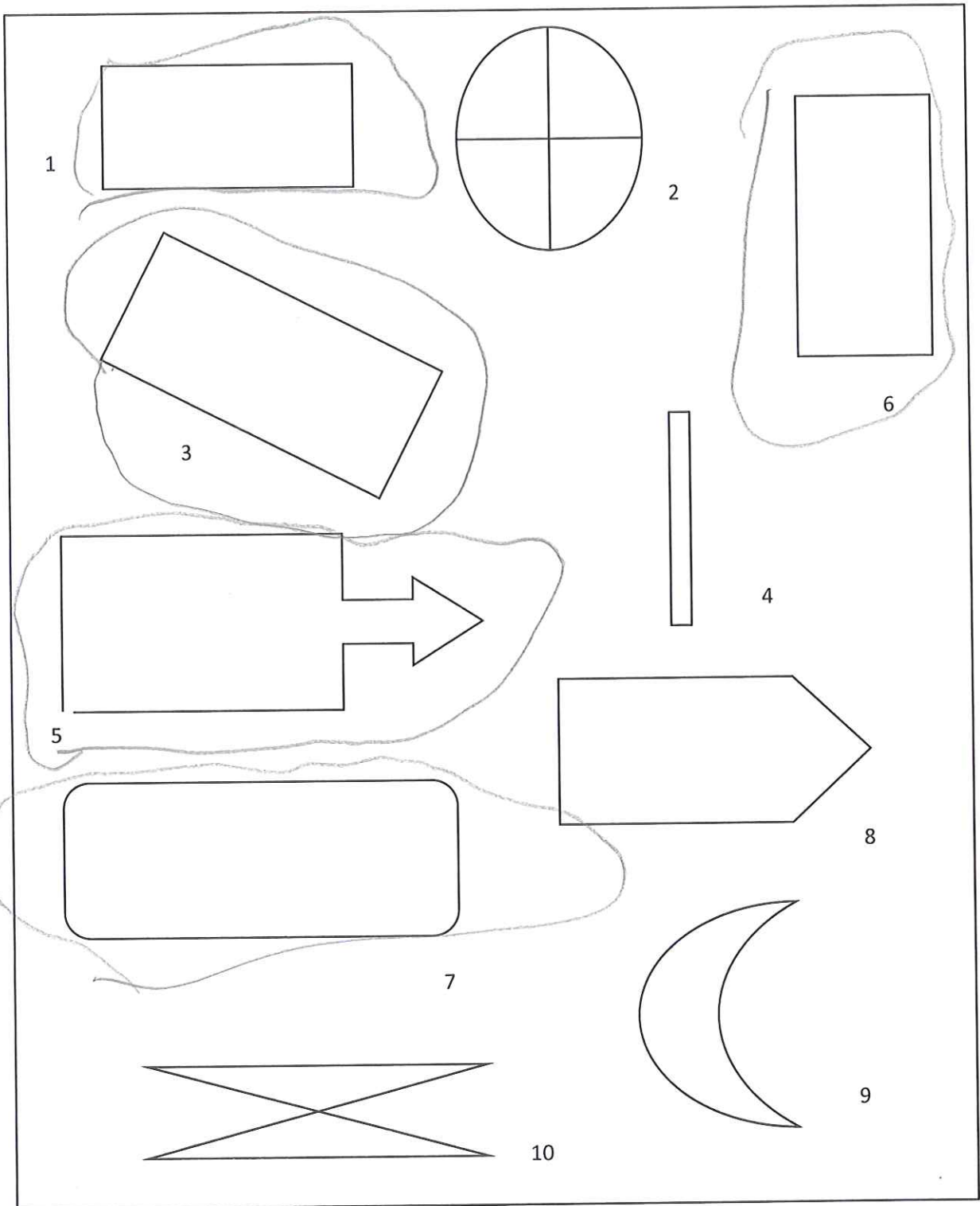

• ENCERCLA ELS TRIANGLES

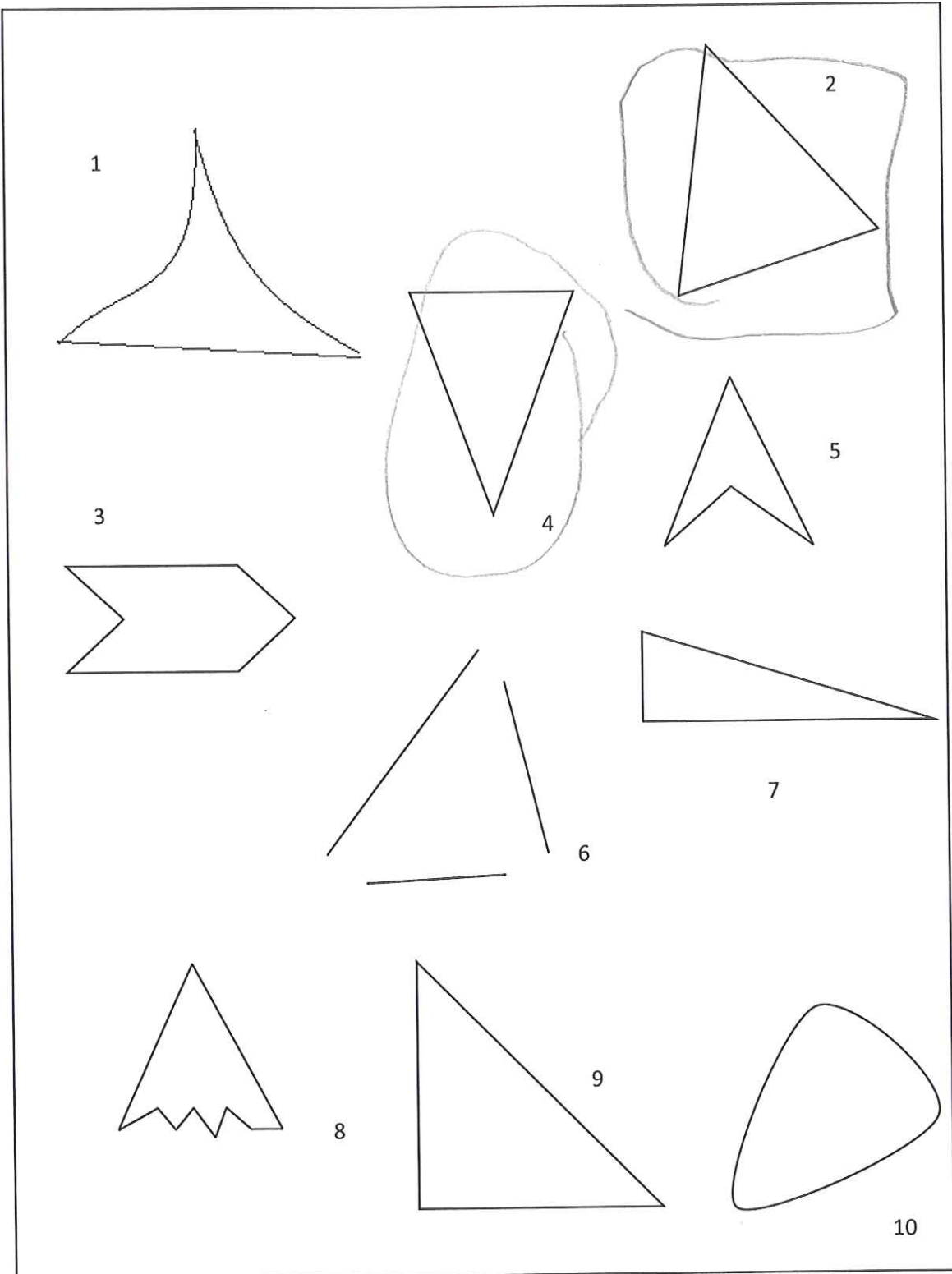

TEST PELS INFANTS DE P4B

1. DIBUIXA UN QUADRAT

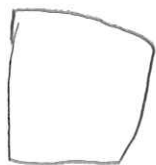

2. DIBUIXA UN RECTANGLE

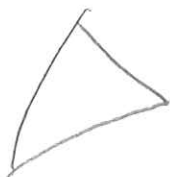

3. DIBUIXA UN TRIANGLE



4. DIBUIXA UN CERCLE



5. QUANTS COSTATS TENEN AQUESTES FIGURES GEOMÈTRIQUES I VÈRTEXS

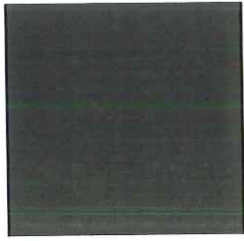

Costats

X

Vèrtexs

X

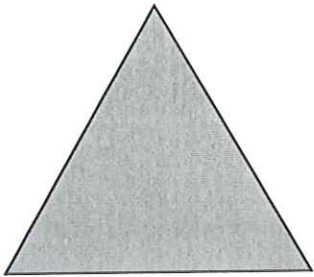

3

X



X

X



X

X

6. IDENTIFICA I ENCERCLA LES FIGURES GEOMÈTRIQUES.

- ENCERCLA ELS CERCLES

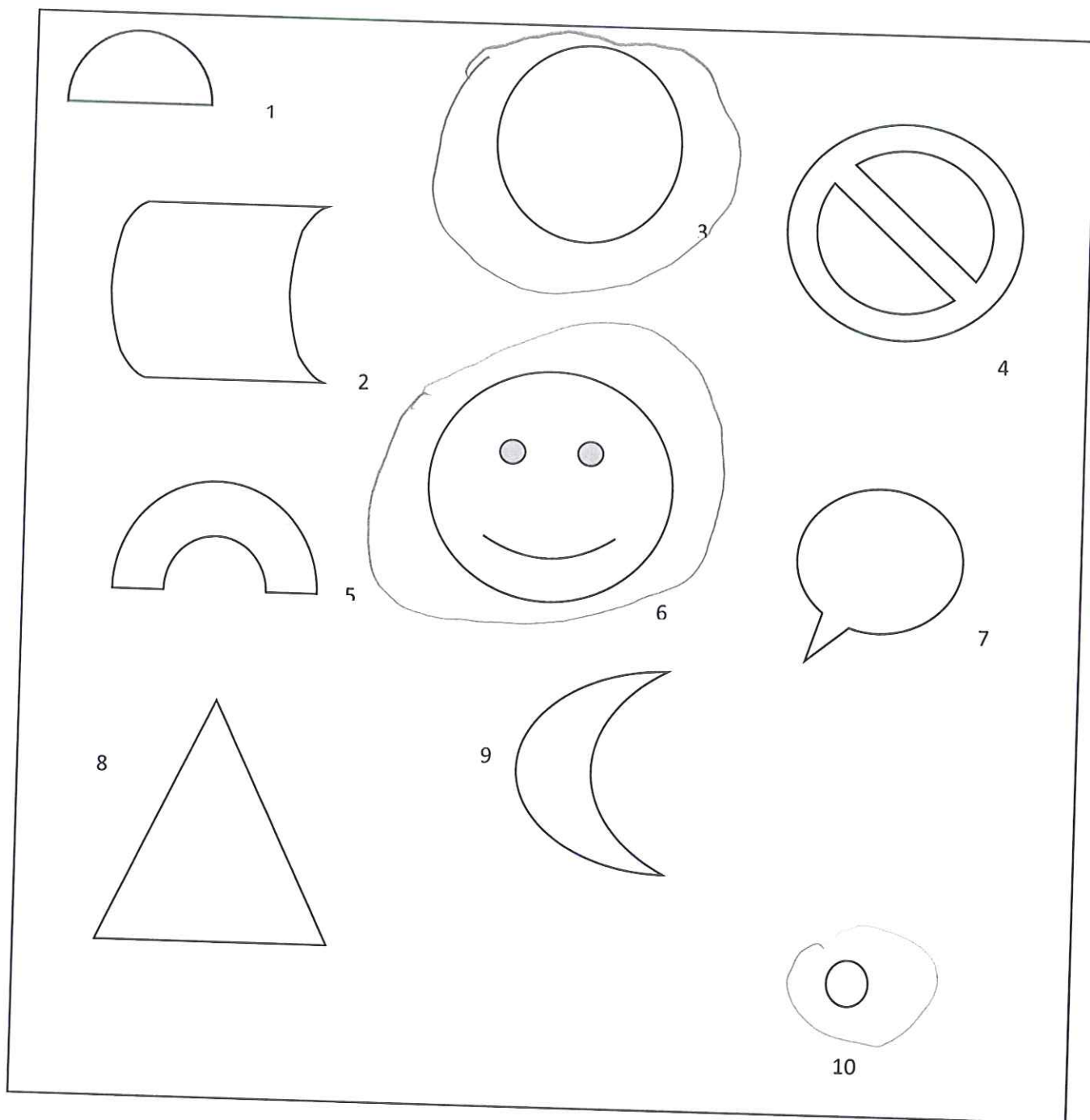

• ENCERCLA ELS QUADRATS

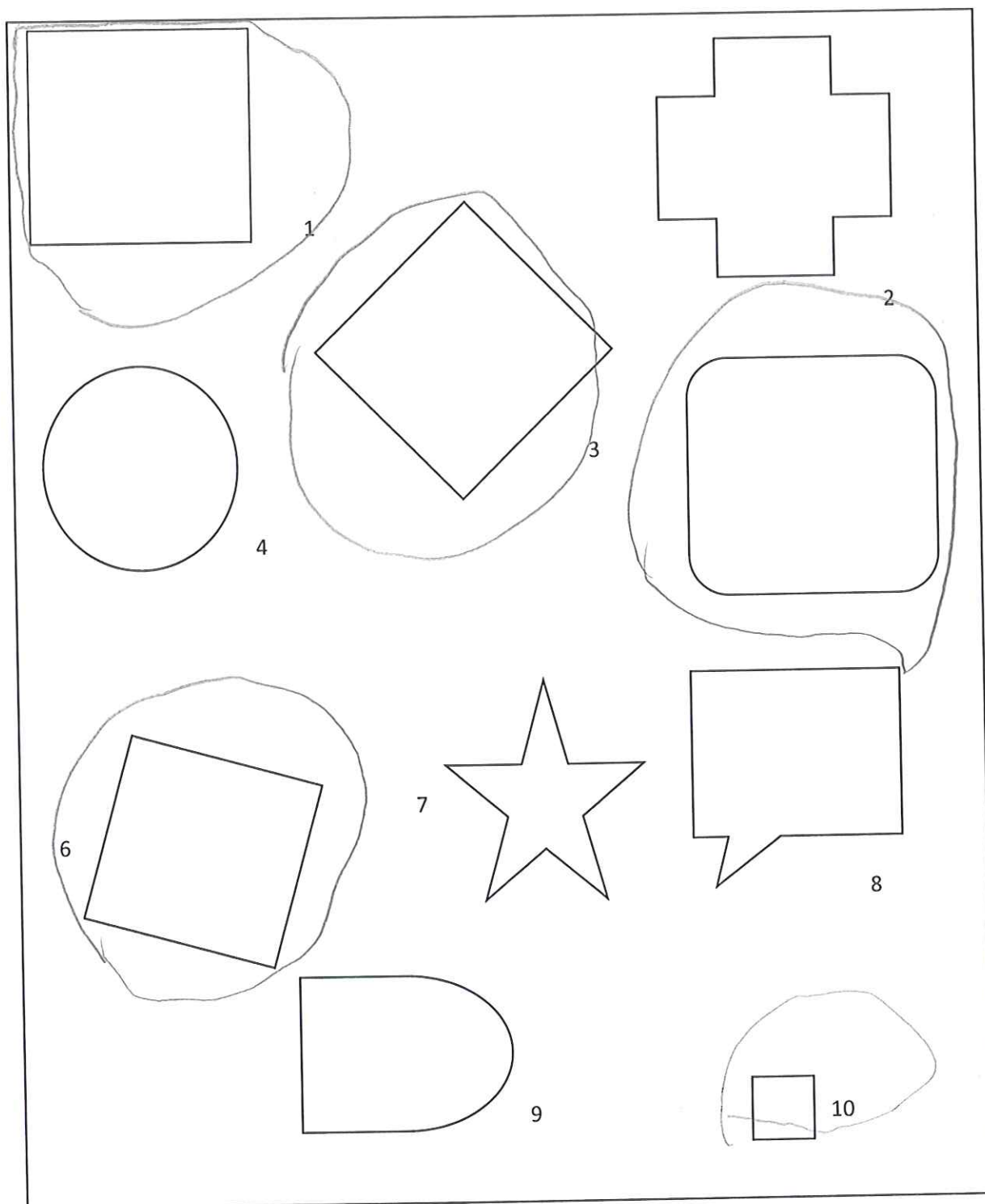

- ENCERCLA ELS RECTANGLES

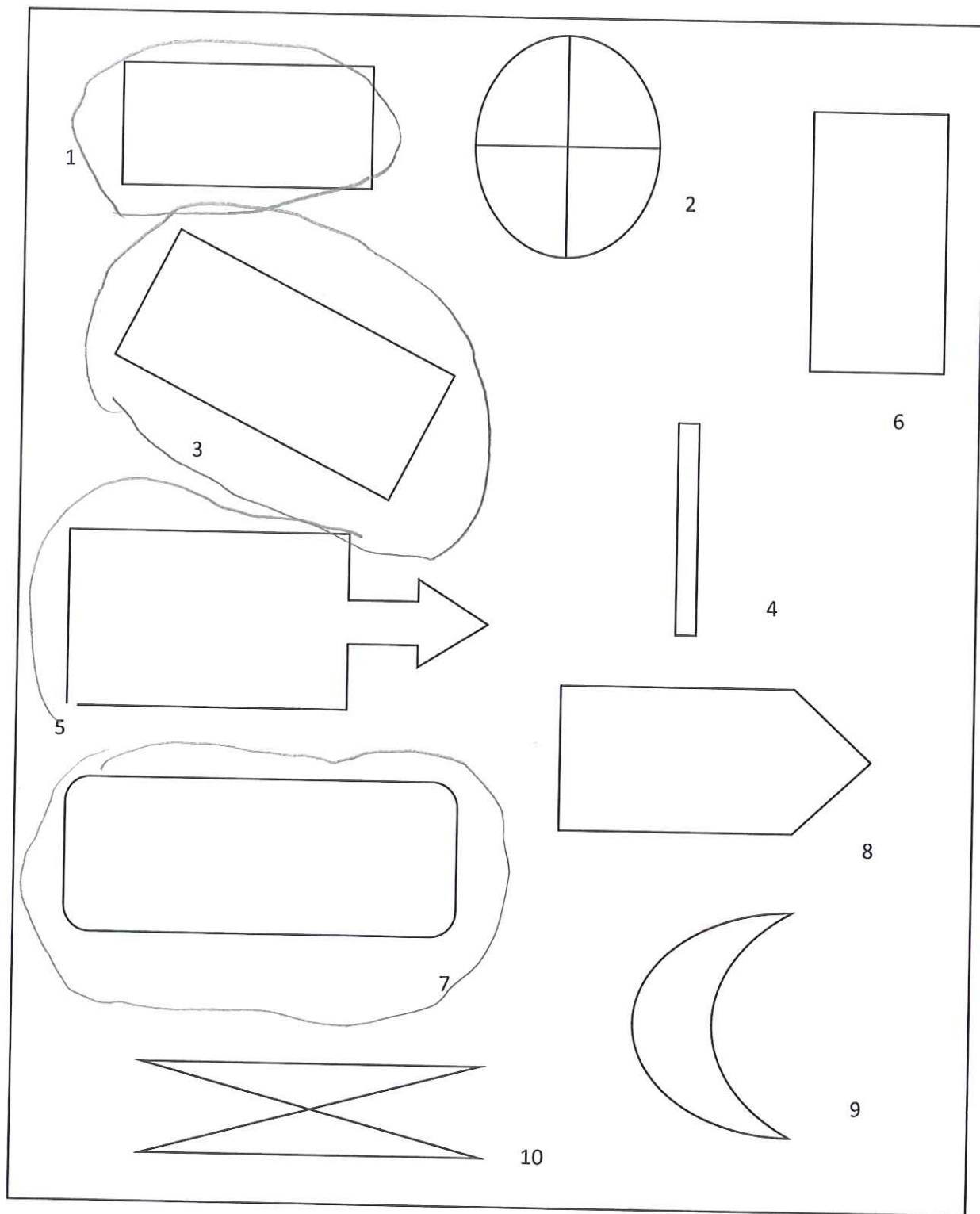

• ENCERCLA ELS TRIANGLES

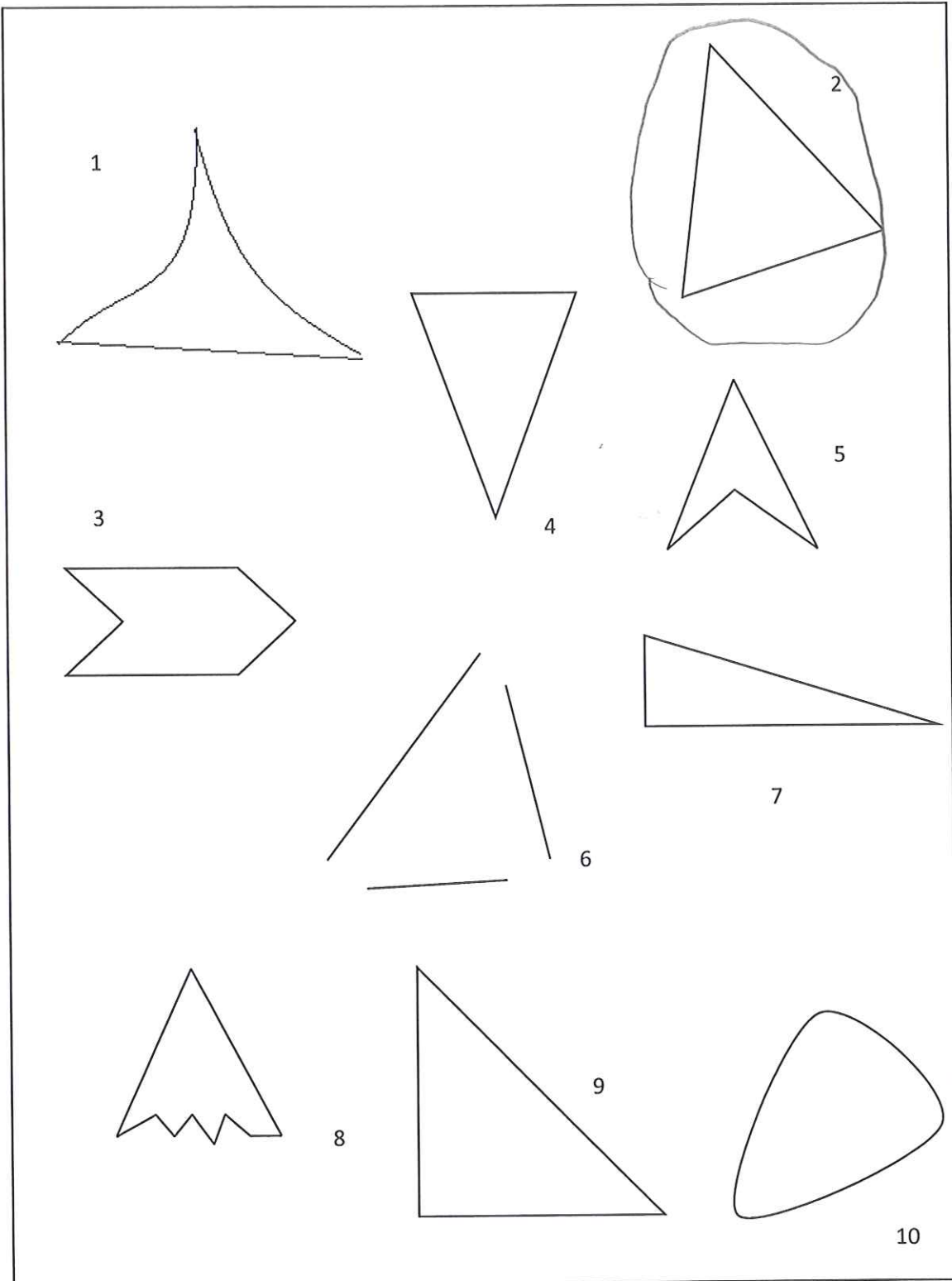

TEST PELS INFANTS DE P4B

1. DIBUIXA UN QUADRAT



2. DIBUIXA UN RECTANGLE



3. DIBUIXA UN TRIANGLE



4. DIBUIXA UN CERCLE



5. QUANTS COSTATS TENEN AQUESTES FIGURES GEOMÈTRIQUES I VÈRTEXS

Costats

Vèrtexs,

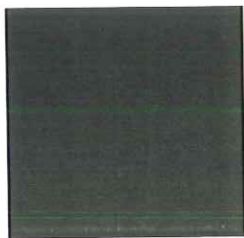

4

4

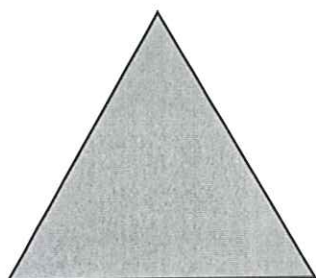

3

3



0

0



4

4

6. IDENTIFICA I ENCERCLA LES FIGURES GEOMÈTRIQUES.

- ENCERCLA ELS CERCLES

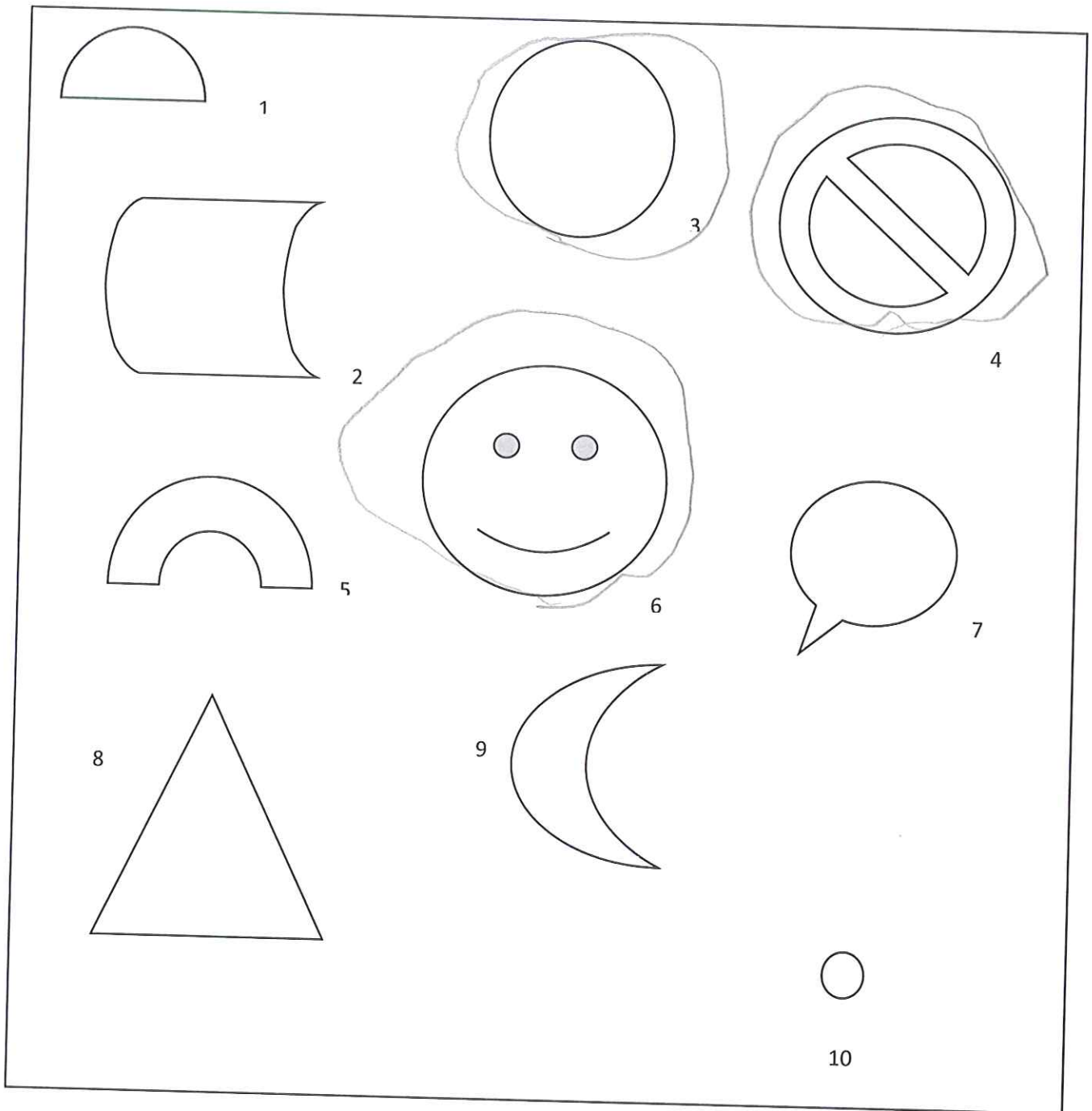

• ENCERCLA ELS QUADRATS

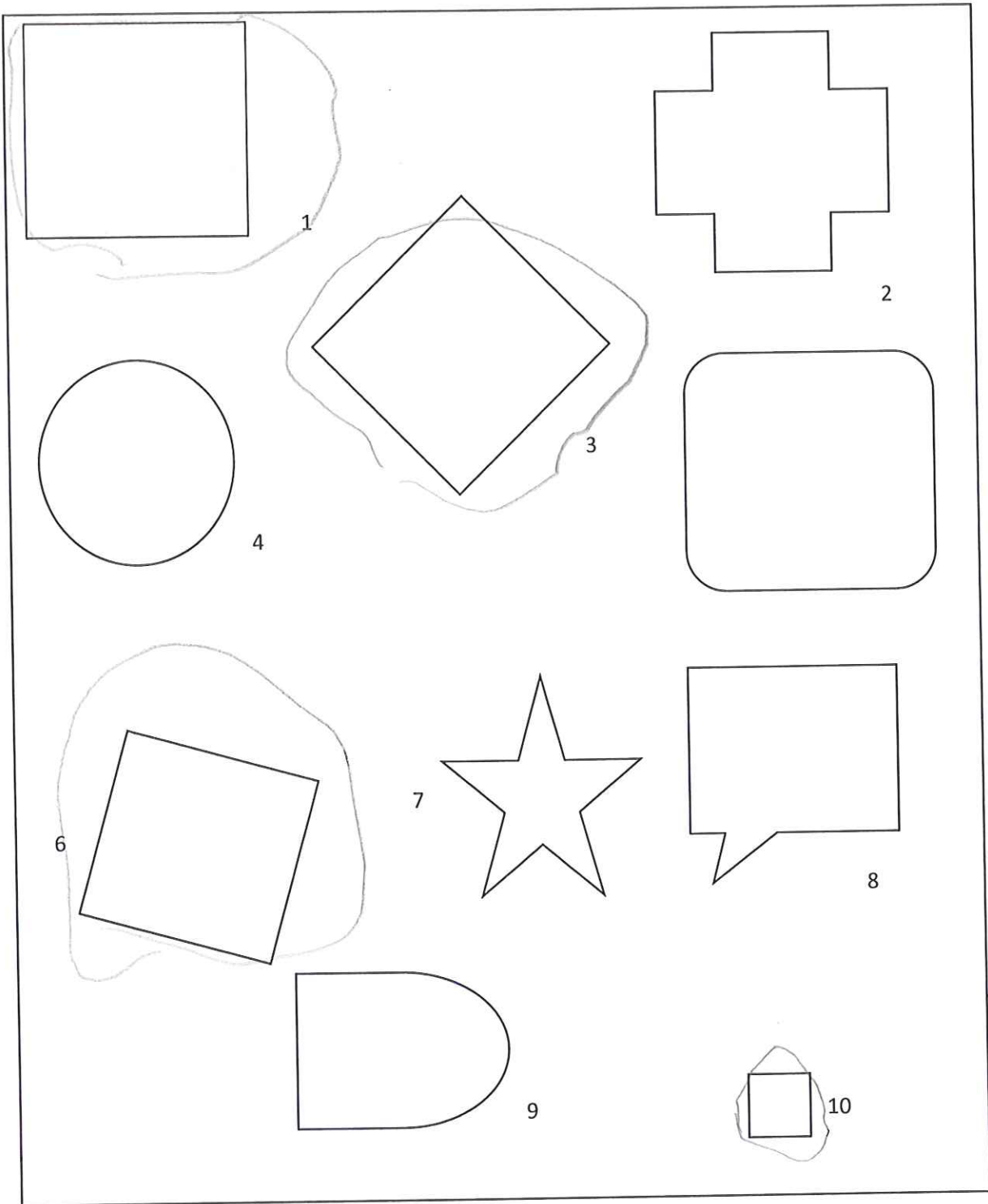

• ENCERCLA ELS RECTANGLES

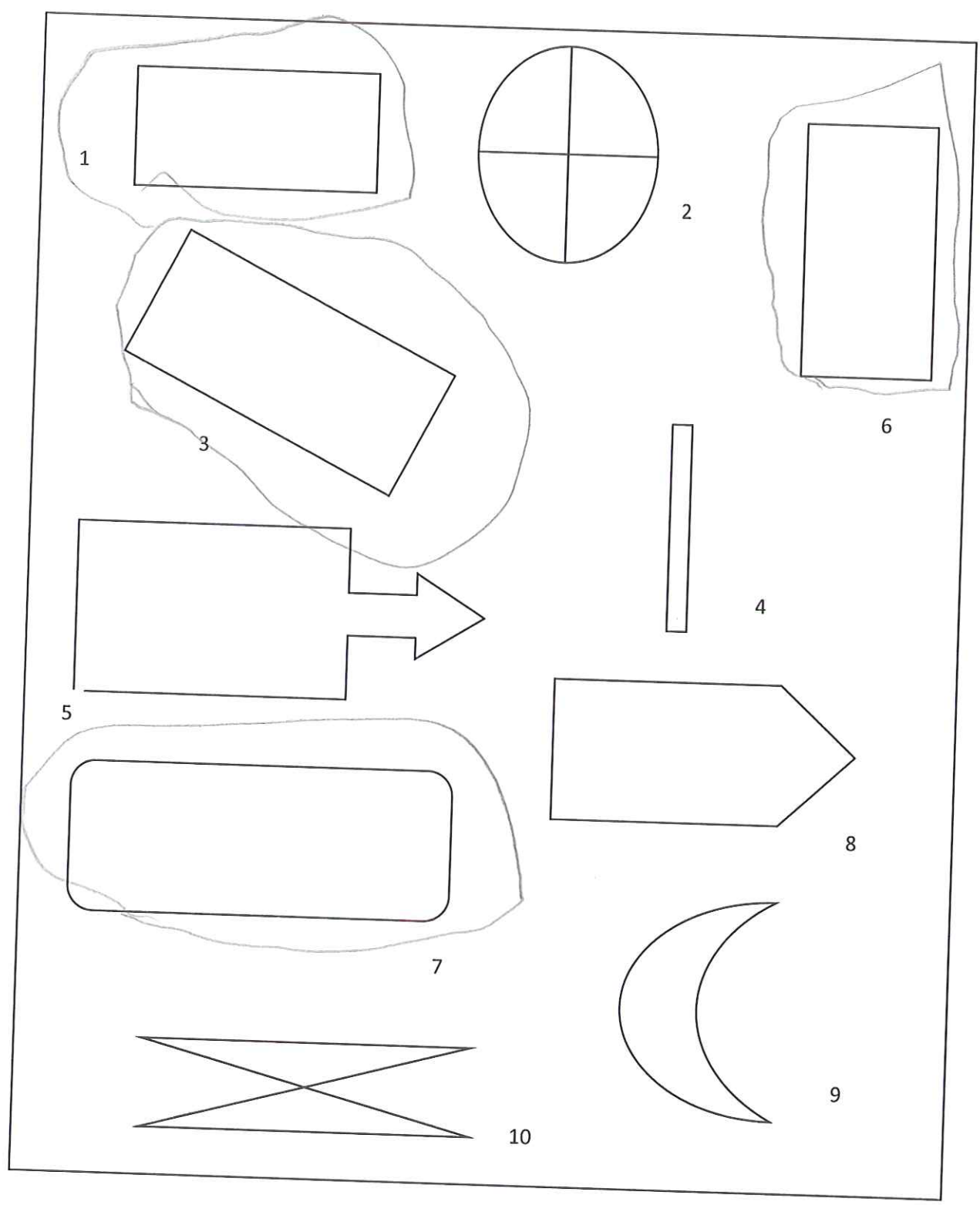

• ENCERCLA ELS TRIANGLES

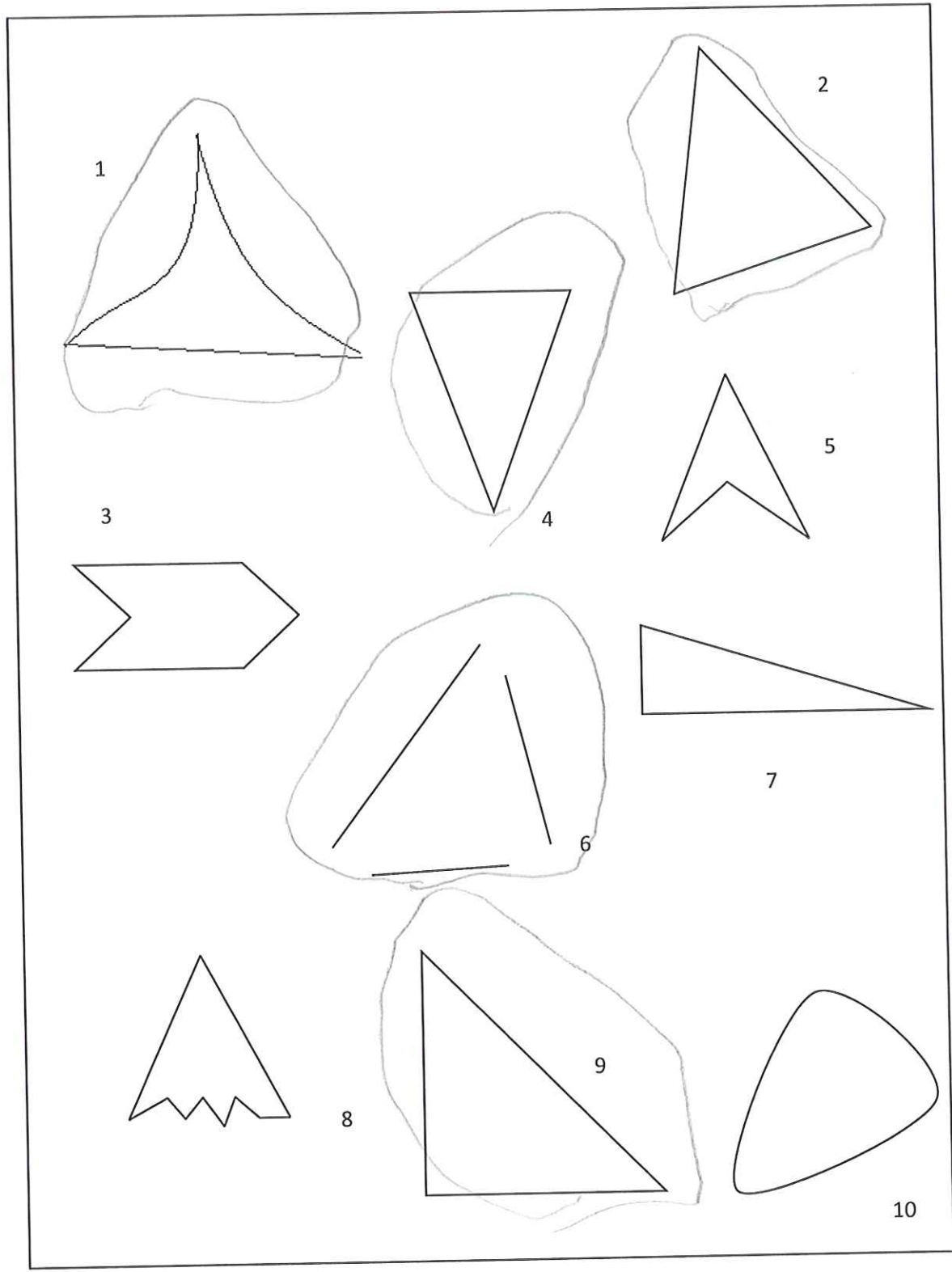

TEST PELS INFANTS DE P4B

1. DIBUIXA UN QUADRAT

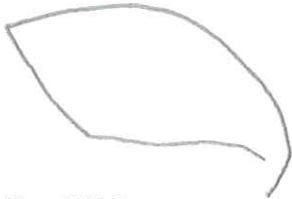

2. DIBUIXA UN RECTANGLE

3. DIBUIXA UN TRIANGLE



4. DIBUIXA UN CERCLE



5. QUANTS COSTATS TENEN AQUESTES FIGURES GEOMÈTRIQUES I VÈRTEXS



Costats

4

Vèrtexs.

4

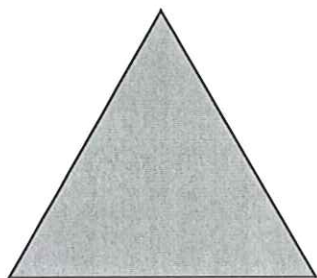

3

3



0

0



4

4

6. IDENTIFICA I ENCERCLA LES FIGURES GEOMÈTRIQUES.

- ENCERCLA ELS CERCLES

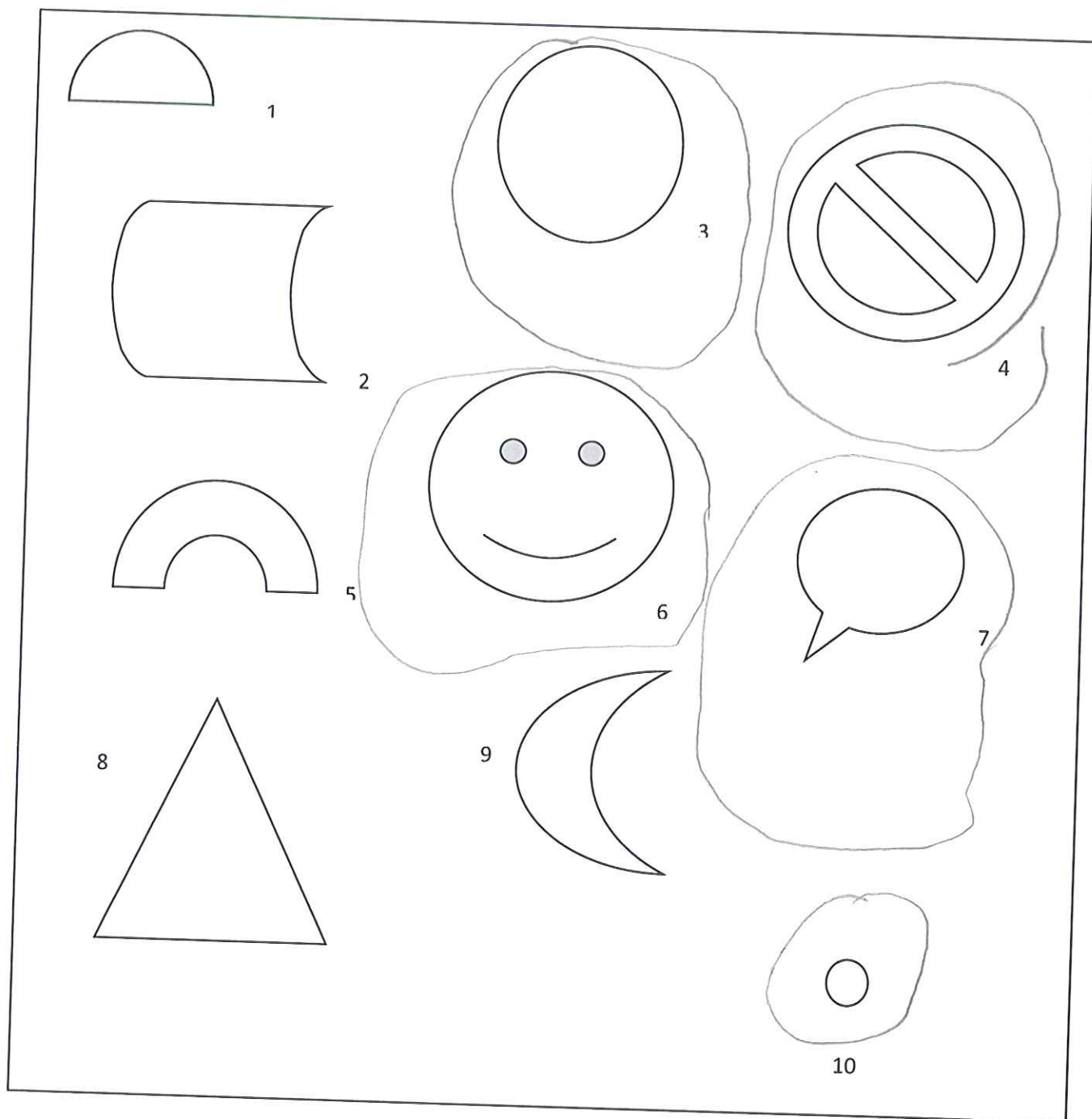

• ENCERCLA ELS QUADRATS

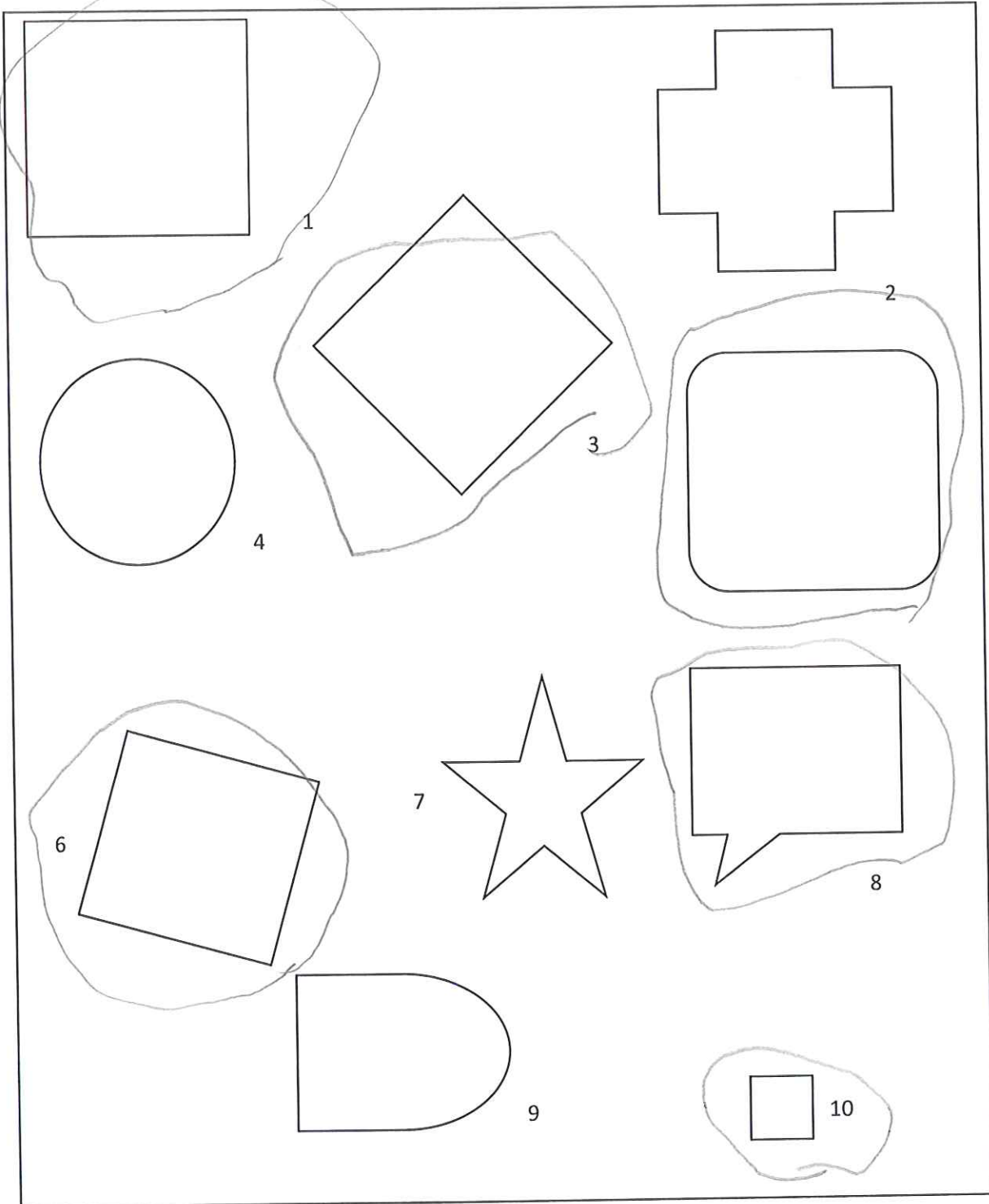

- ENCERCLA ELS RECTANGLES

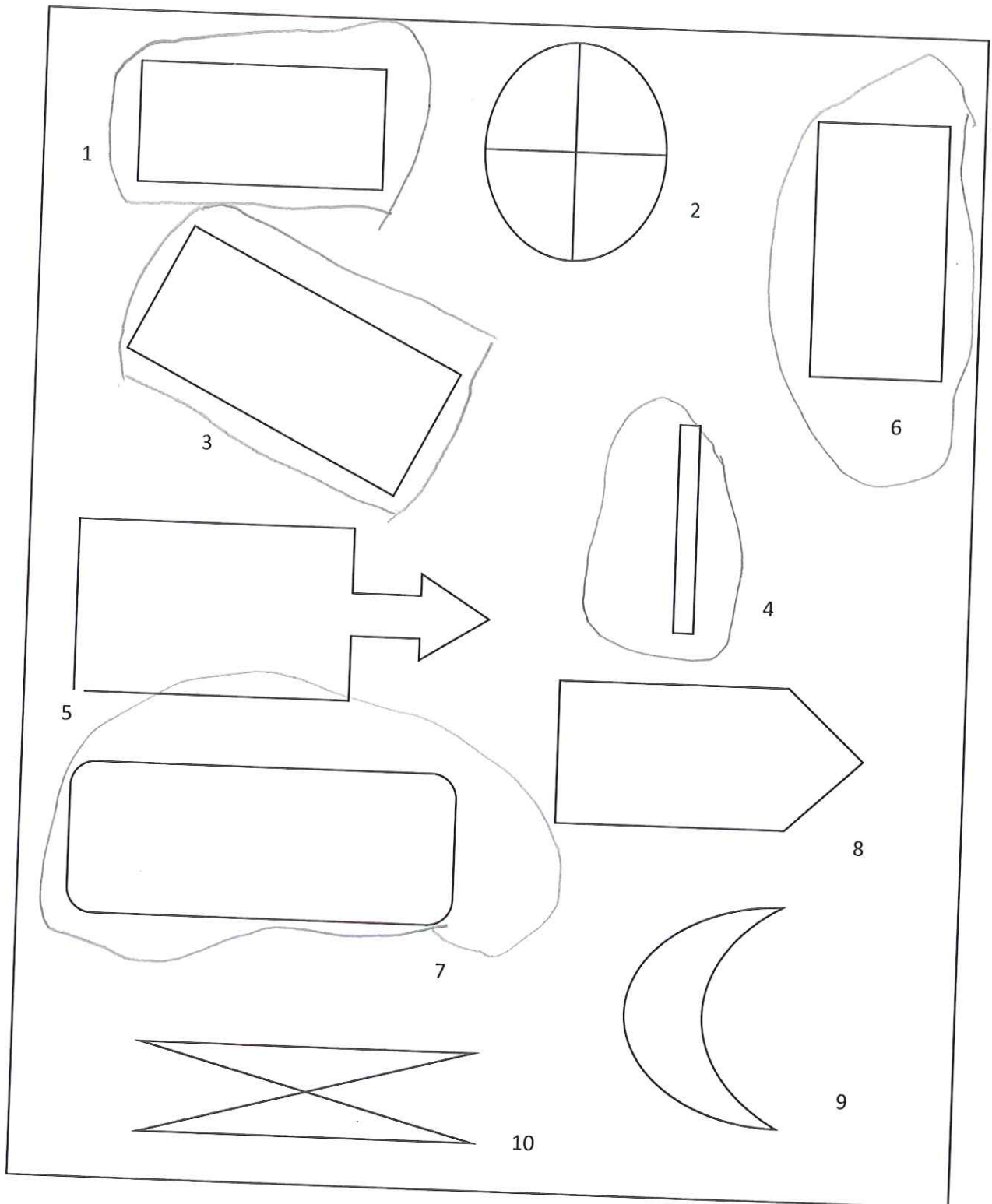

• ENCERCLA ELS TRIANGLES

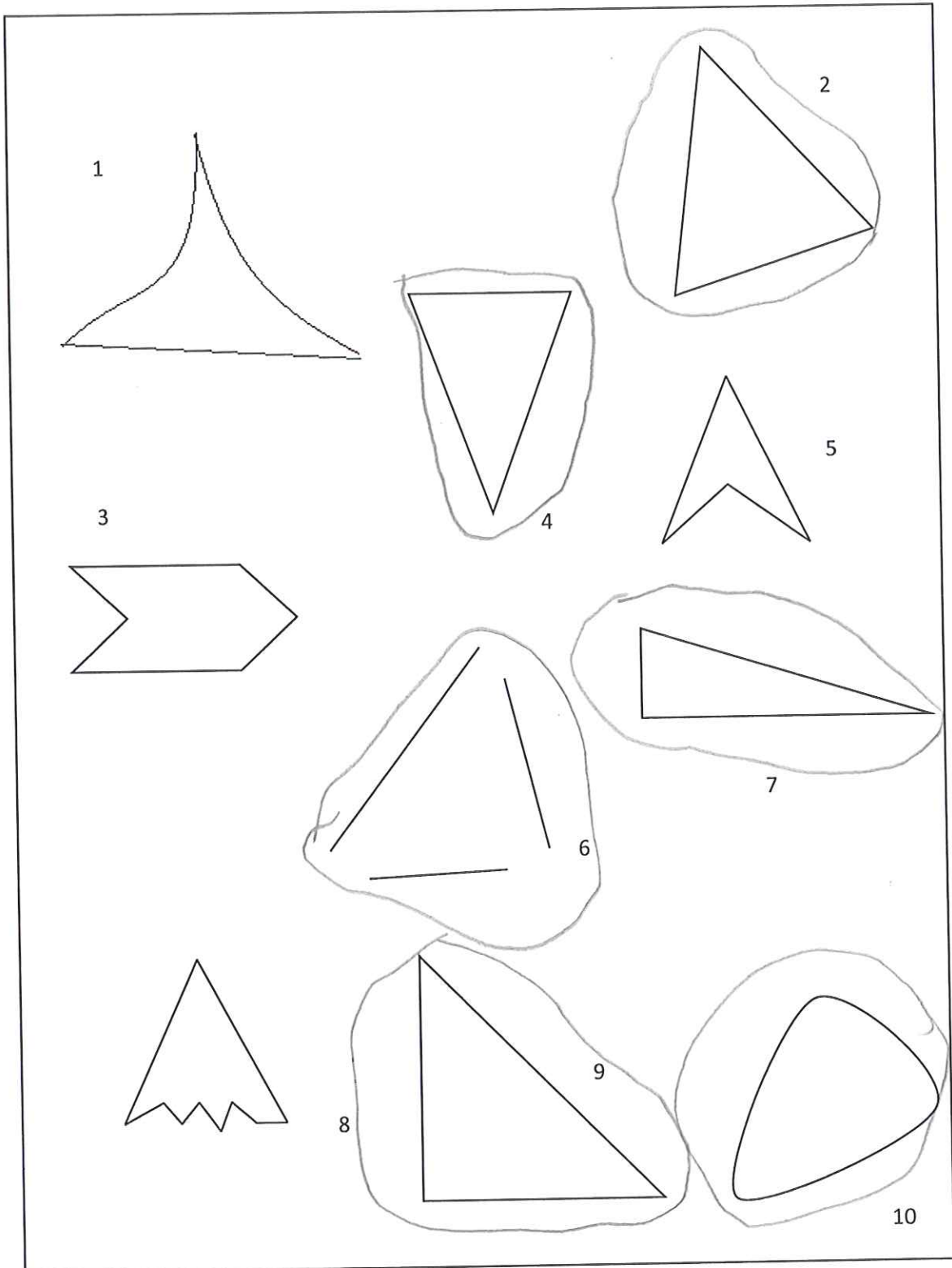

TEST PELS INFANTS DE P4B

1. DIBUIXA UN QUADRAT



2. DIBUIXA UN RECTANGLE

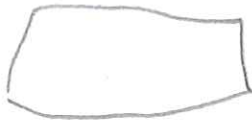

3. DIBUIXA UN TRIANGLE

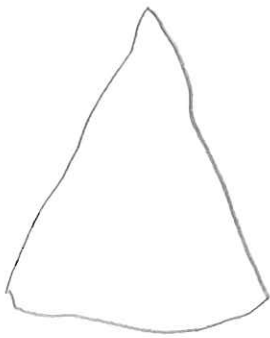

4. DIBUIXA UN CERCLE



5. QUANTS COSTATS TENEN AQUESTES FIGURES GEOMÈTRIQUES I VÈRTEXS

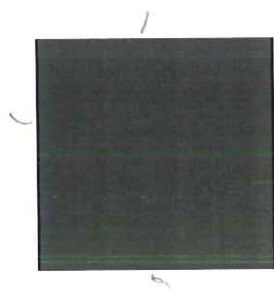

costats

vèrtexs.

4

4

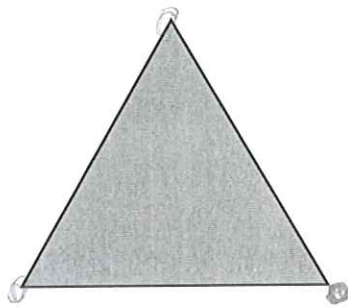

3

3

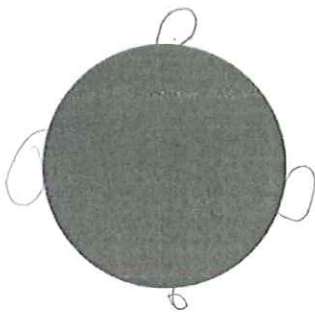

4

4

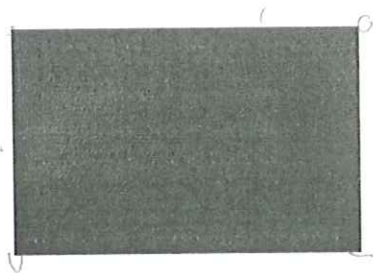

4

4

6. IDENTIFICA I ENCERCLA LES FIGURES GEOMÈTRIQUES.

- ENCERCLA ELS CERCLES

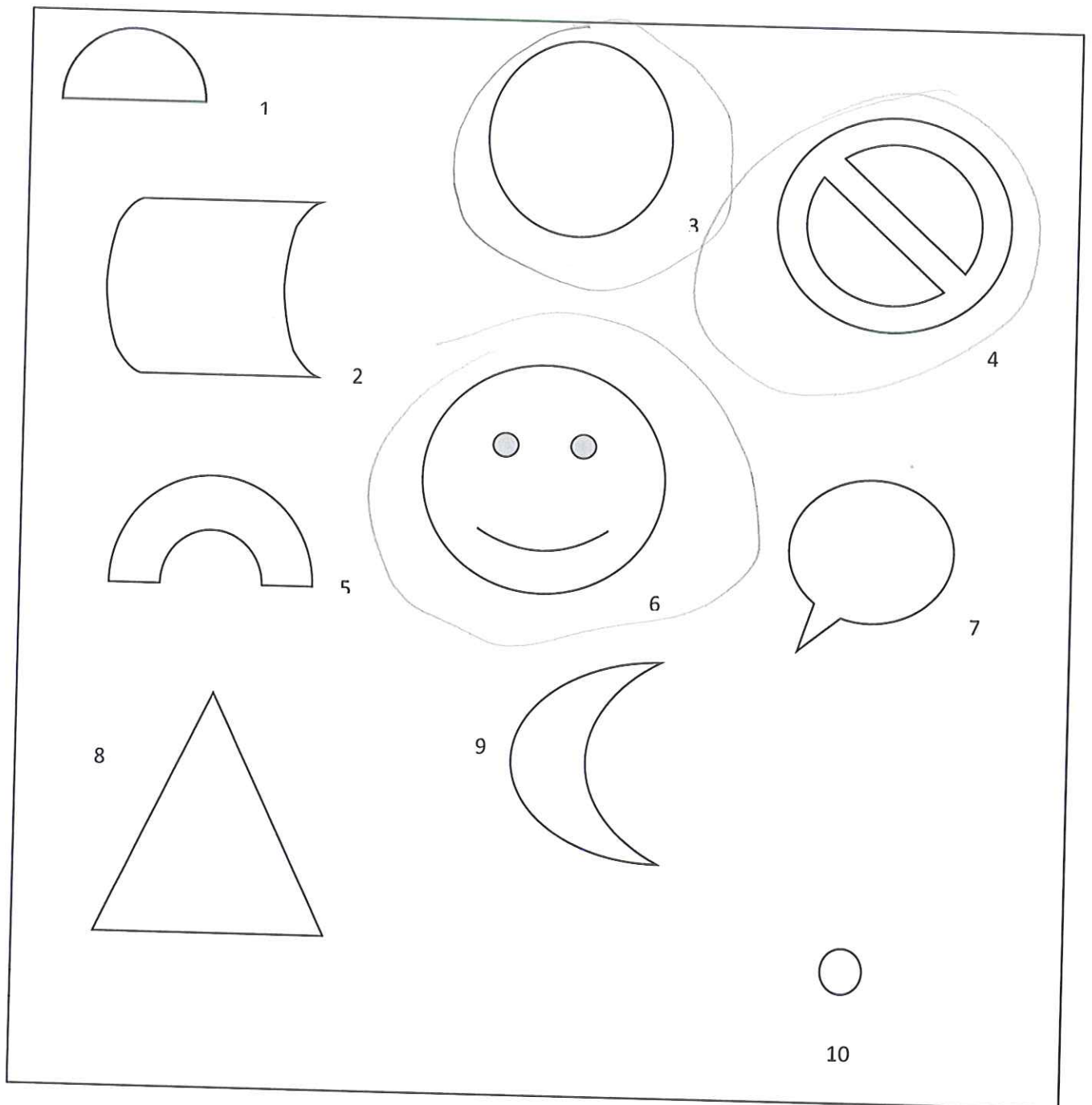

• ENCERCLA ELS QUADRATS

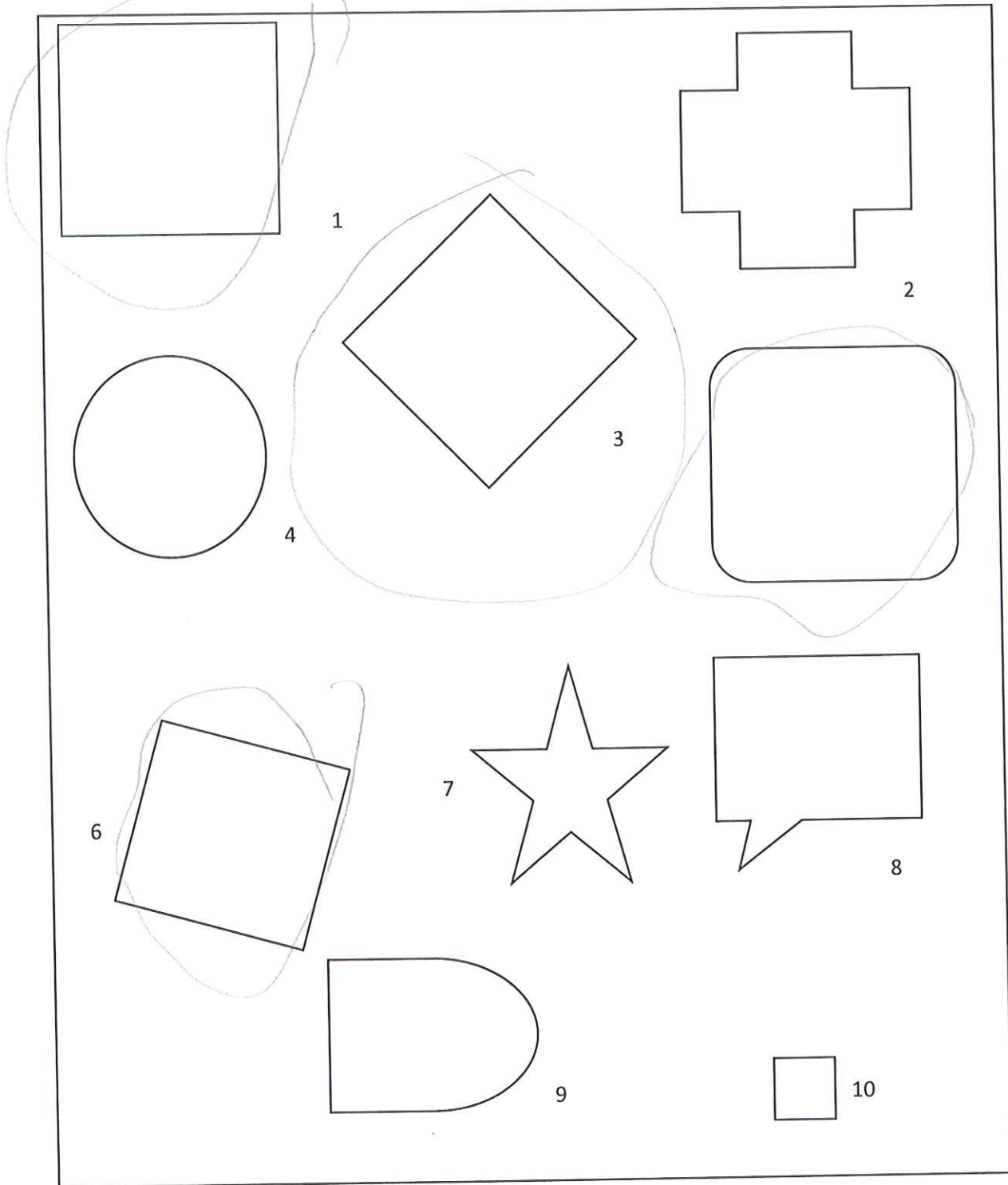

• ENCERCLA ELS RECTANGLES

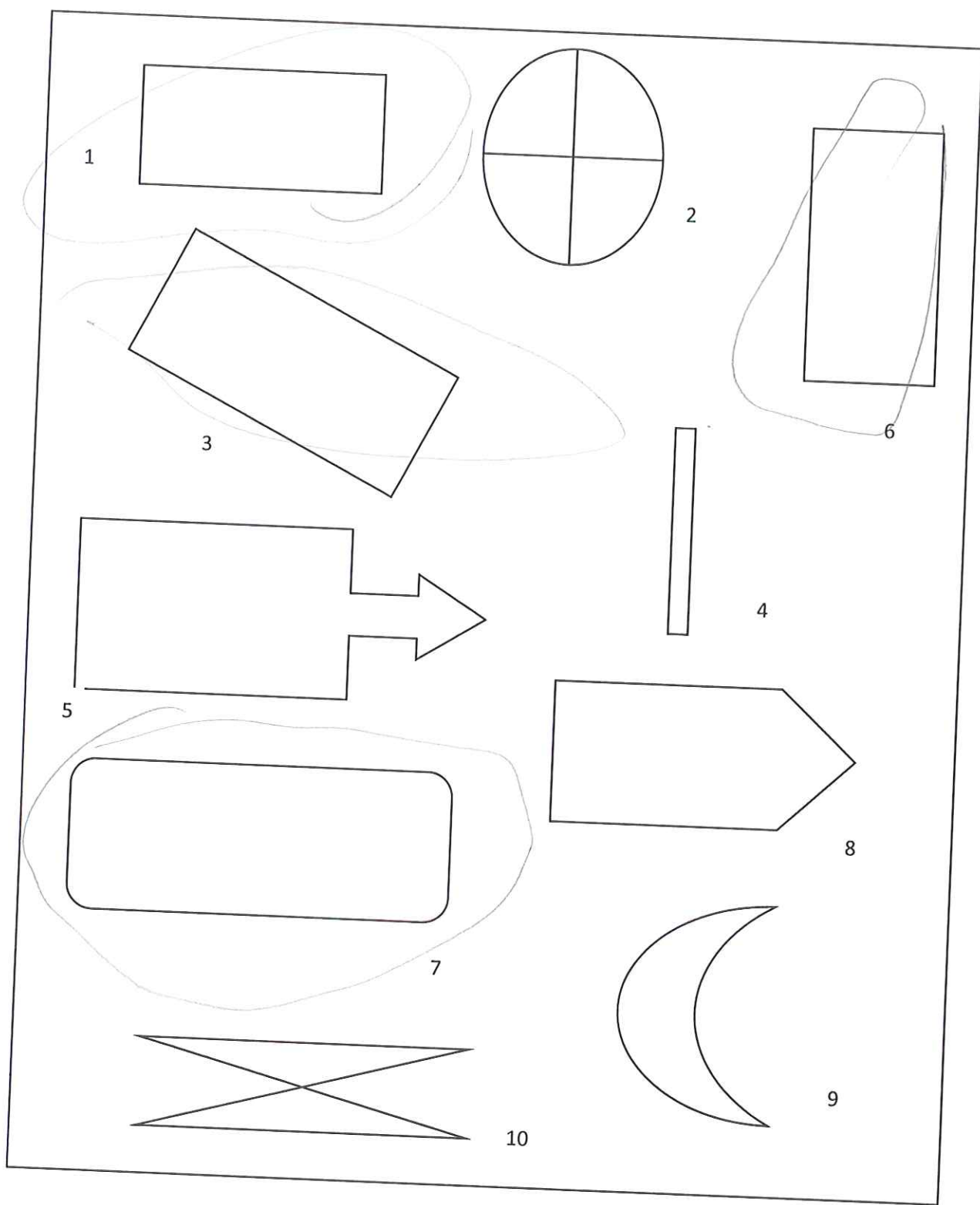

• ENCERCLA ELS TRIANGLES

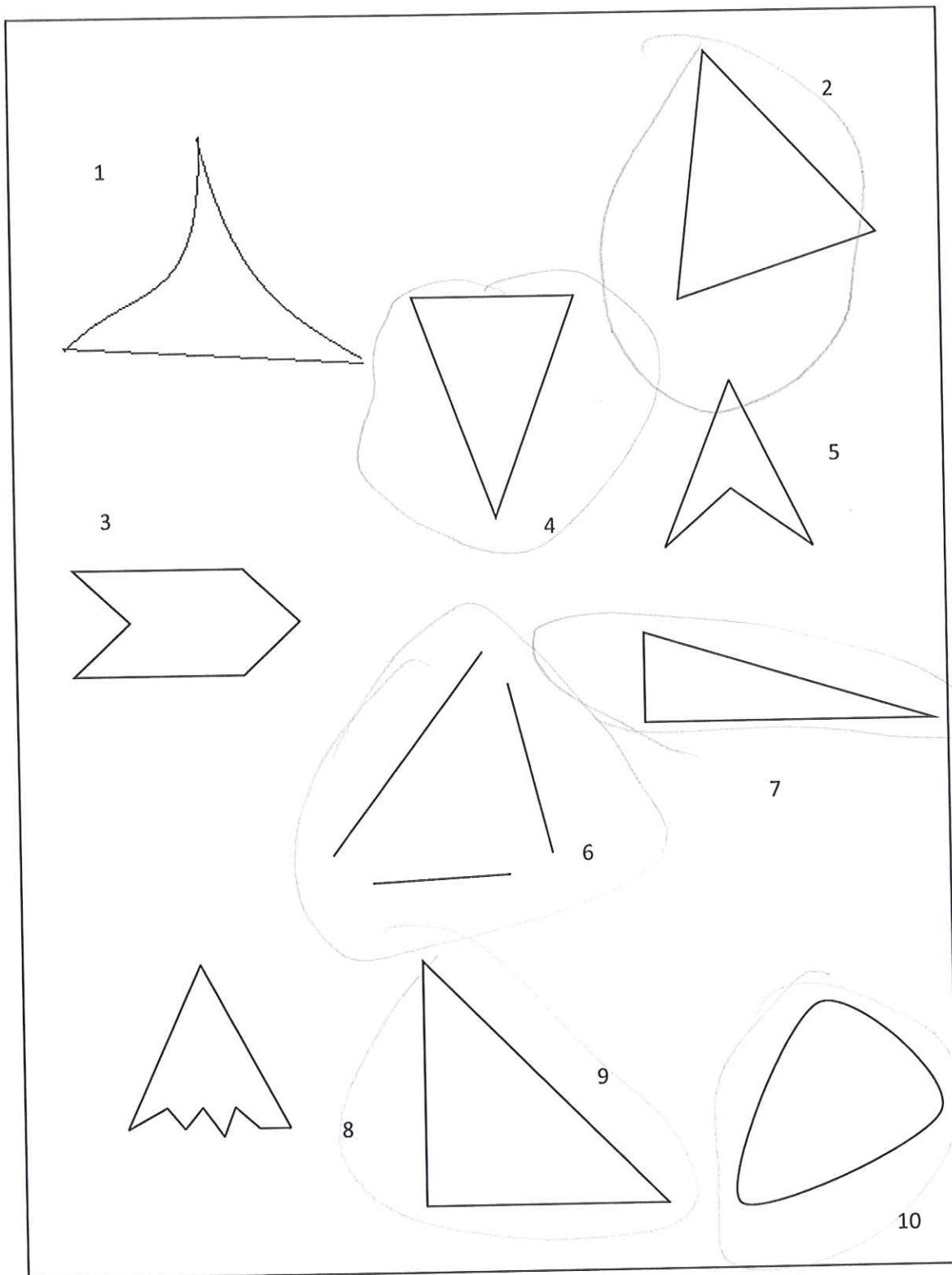

TEST PELS INFANTS DE P4B

1. DIBUIXA UN QUADRAT



2. DIBUIXA UN RECTANGLE



3. DIBUIXA UN TRIANGLE

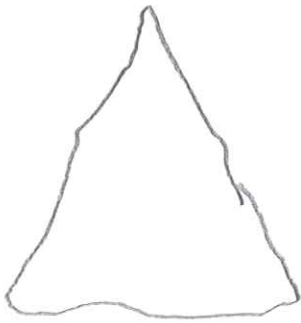

4. DIBUIXA UN CERCLE



5. QUANTS COSTATS TENEN AQUESTES FIGURES GEOMÈTRIQUES I VÈRTEXS



Costats Vèrtexs

4

4

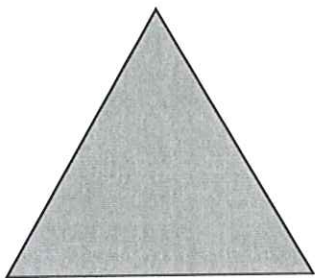

3

3



1

1



4

4

6. IDENTIFICA I ENCERCLA LES FIGURES GEOMÈTRIQUES.

- ENCERCLA ELS CERCLES

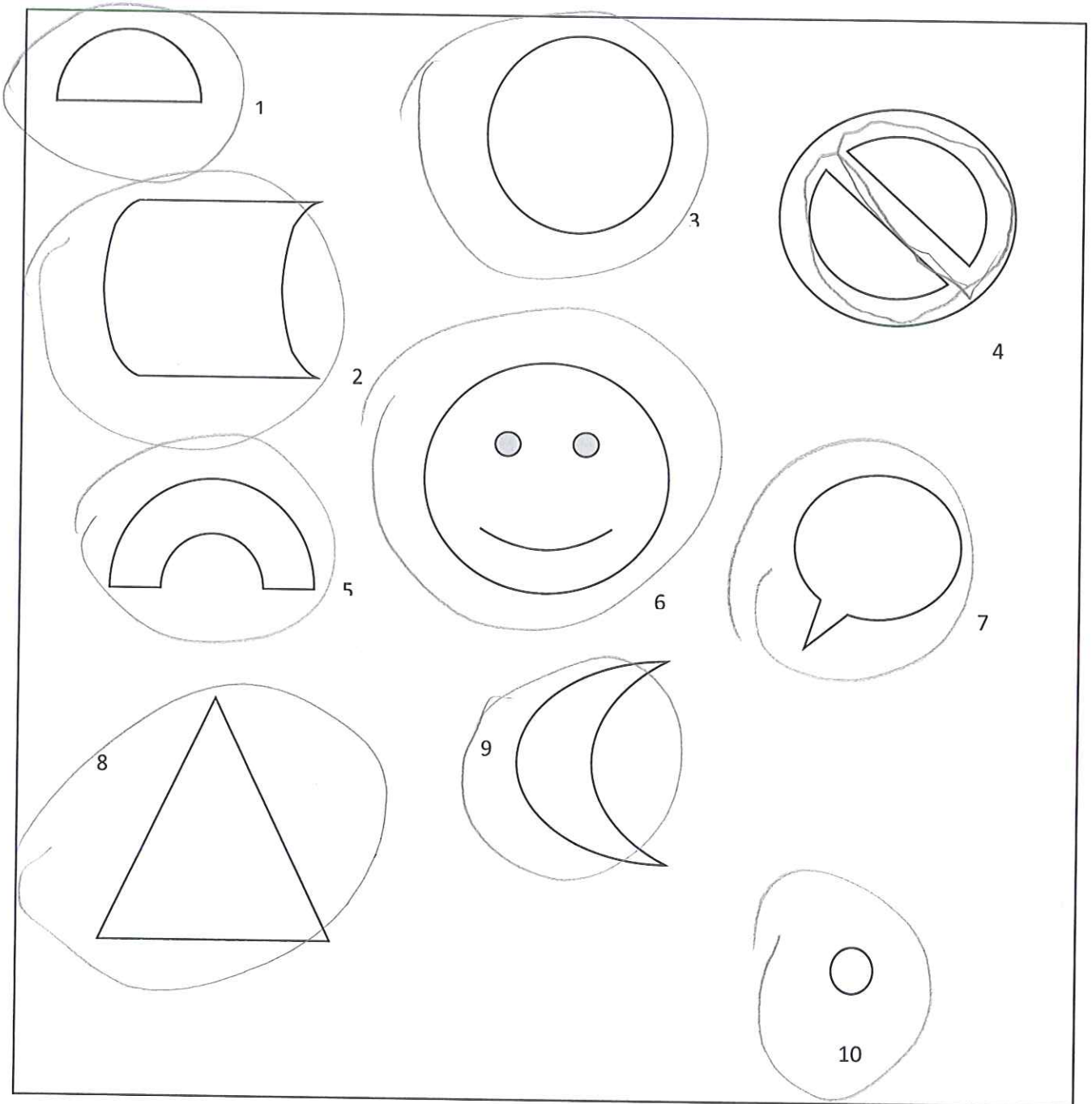

• ENCERCLA ELS QUADRATS

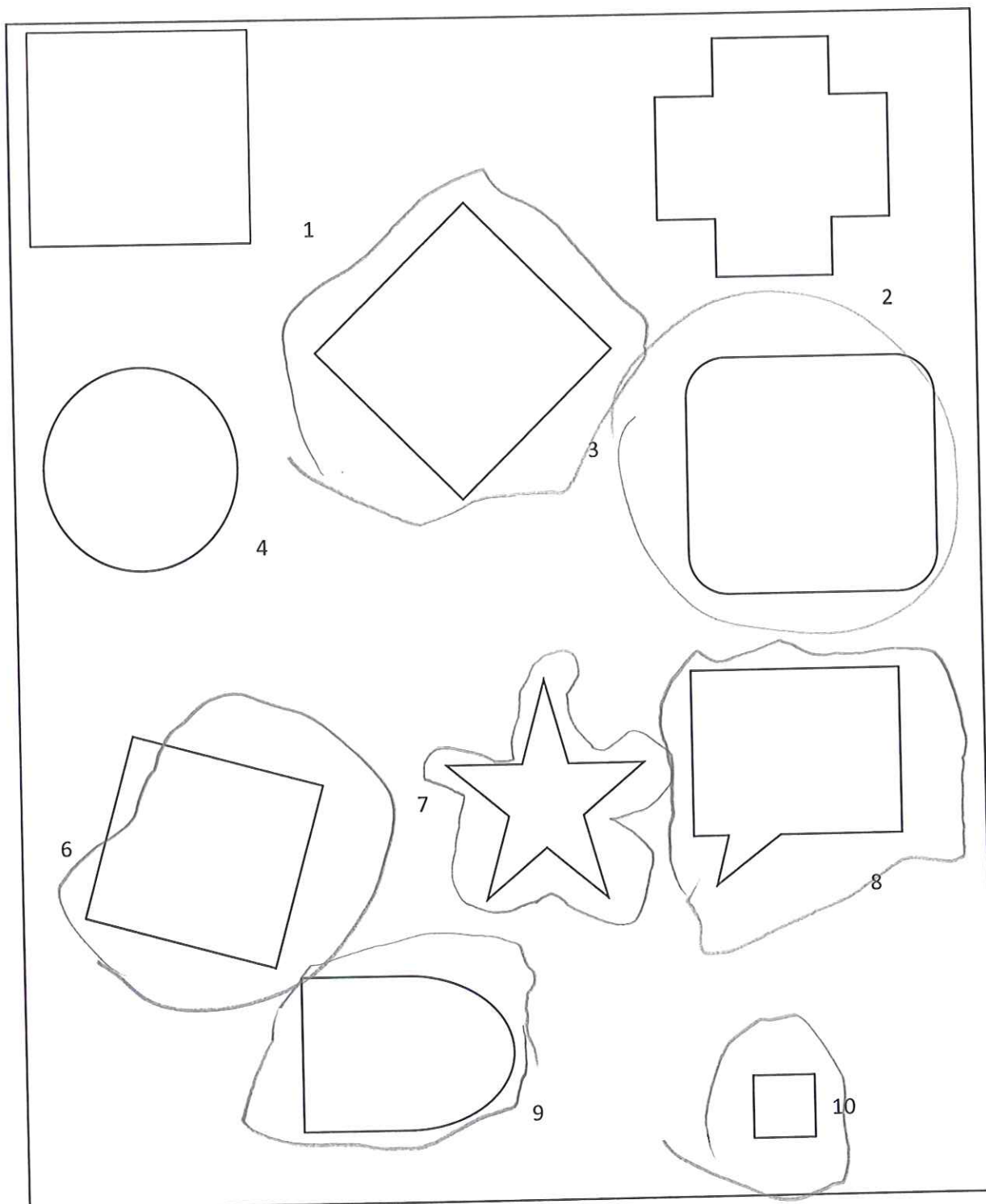

- ENCERCLA ELS RECTANGLES

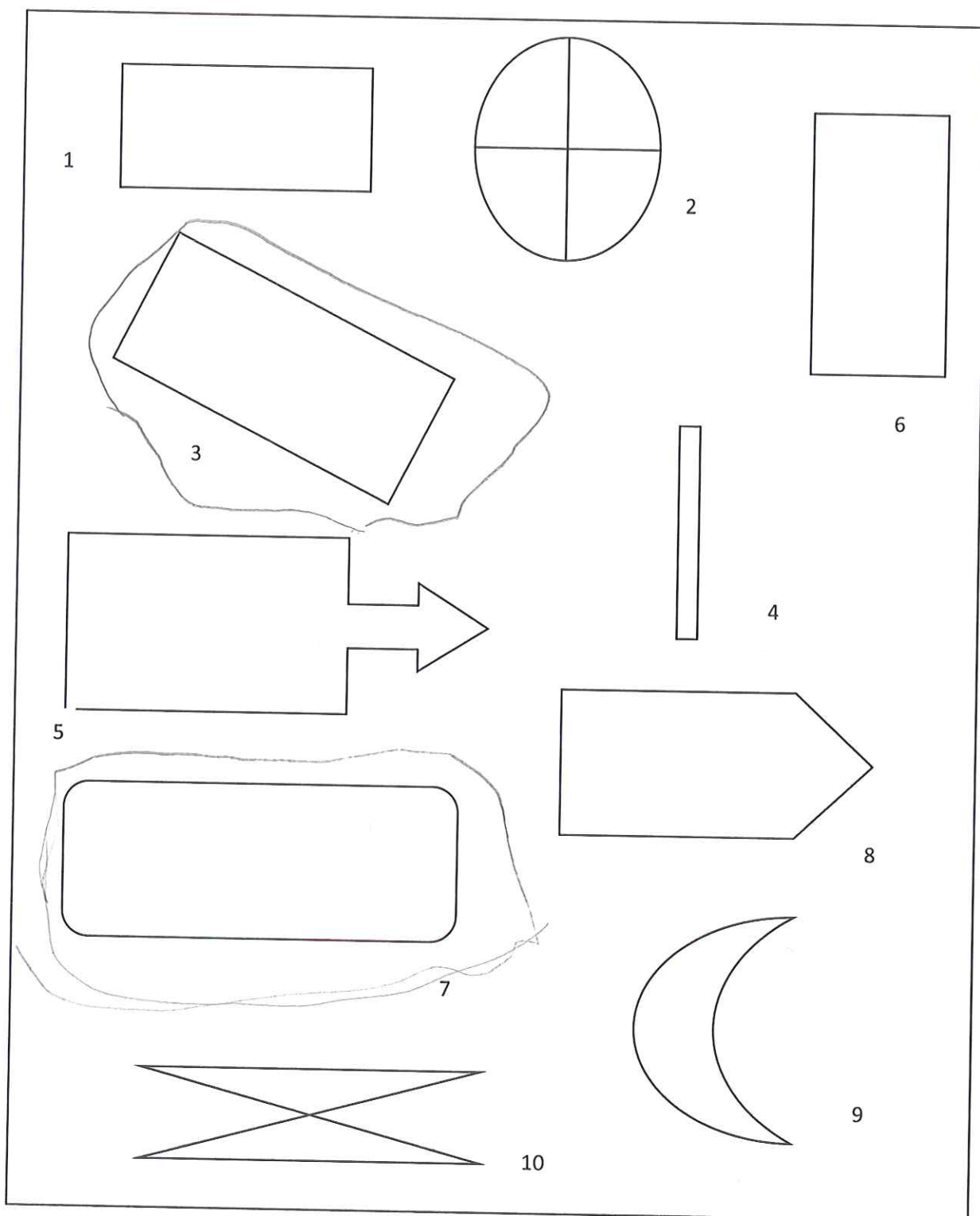

• ENCERCLA ELS TRIANGLES

